

# INTRODUCTION TO COMSOL Multiphysics

# Introduction to COMSOL Multiphysics

© 1998–2023 COMSOL

Protected by patents listed on [www.comsol.com/patents](http://www.comsol.com/patents), or see Help>About COMSOL Multiphysics on the File menu in the COMSOL Desktop for less detailed lists of U.S. Patents that may apply. Patents pending.

This Documentation and the Programs described herein are furnished under the COMSOL Software License Agreement ([www.comsol.com/sla](http://www.comsol.com/sla)) and may be used or copied only under the terms of the license agreement.

COMSOL, the COMSOL logo, COMSOL Multiphysics, COMSOL Desktop, COMSOL Compiler, COMSOL Server, and LiveLink are either registered trademarks or trademarks of COMSOL AB. All other trademarks are the property of their respective owners, and COMSOL AB and its subsidiaries and products are not affiliated with, endorsed by, sponsored by, or supported by those trademark owners. For a list of such trademark owners, see [www.comsol.com/trademarks](http://www.comsol.com/trademarks).

Version: COMSOL 6.2

## Contact Information

Visit the Contact COMSOL page at [www.comsol.com/contact](http://www.comsol.com/contact) to submit general inquiries or search for an address and phone number. You can also visit the Worldwide Sales Offices page at [www.comsol.com/contact/offices](http://www.comsol.com/contact/offices) for address and contact information.

If you need to contact Support, an online request form is located on the COMSOL Access page at [www.comsol.com/support/case](http://www.comsol.com/support/case). Other useful links include:

- Support Center: [www.comsol.com/support](http://www.comsol.com/support)
- Product Download: [www.comsol.com/product-download](http://www.comsol.com/product-download)
- Product Updates: [www.comsol.com/product-update](http://www.comsol.com/product-update)
- COMSOL Blog: [www.comsol.com/blogs](http://www.comsol.com/blogs)
- Discussion Forum: [www.comsol.com/forum](http://www.comsol.com/forum)
- Events: [www.comsol.com/events](http://www.comsol.com/events)
- COMSOL Video Gallery: [www.comsol.com/videos](http://www.comsol.com/videos)
- Support Knowledge Base: [www.comsol.com/support/knowledgebase](http://www.comsol.com/support/knowledgebase)

Part number: CM010004

# Contents

---

Introduction .....	5
COMSOL Desktop® .....	6
Example 1: Structural Analysis of a Wrench.....	38
Model Wizard.....	39
Geometry .....	41
Materials .....	44
Global Definitions.....	46
Physics and Boundary Conditions .....	48
Mesh .....	56
Study .....	58
Results.....	59
Convergence Analysis .....	66
Example 2: The Busbar — A Multiphysics Model .....	75
Model Wizard .....	78
Global Definitions .....	81
The Auto Completion and Find Tools .....	83
Geometry .....	85
Materials .....	89
Physics and Boundary Conditions .....	96
Mesh .....	103
Study .....	106
Results.....	107

Building an Application with the Application Builder . . . . .	117
Overview of Advanced Topics. . . . .	134
Advanced Topics. . . . .	135
Parameters, Functions, Variables, and Couplings . . . . .	136
Material Properties and Material Libraries . . . . .	141
Adding Meshes. . . . .	143
Adding Physics . . . . .	146
Parametric Sweeps . . . . .	169
Parallel Computing . . . . .	181
COMSOL Multiphysics Client–Server. . . . .	185
Using the Model Manager . . . . .	188
Creating a Local Database . . . . .	189
Version Control . . . . .	192
Working with a Draft of the Model . . . . .	199
Comparing Versions . . . . .	206
Excluding Built, Computed, and Plotted Data . . . . .	208
Importing Auxiliary Data to the Database . . . . .	210
The Model Manager Workspace . . . . .	212
Appendix A — Building a Geometry . . . . .	214
Appendix B — Keyboard and Mouse Shortcuts. . . . .	231
Appendix C — Language Elements and Reserved Names . .	239
Appendix D — File Formats . . . . .	256
Appendix E — Connecting with LiveLink™ Add-Ons. . . . .	263
Index. . . . .	265

## Introduction

---

Read this book if you are new to COMSOL Multiphysics®. It provides an overview of the COMSOL® environment with examples that show you how to use the COMSOL Desktop® user interface and the Model Builder. It also provides a quick introduction to creating applications and add-ins using the Application Builder as well as a quick introduction to the Model Manager.

If you have not yet installed the software, install it now according to the instructions at [www.comsol.com/product-download](http://www.comsol.com/product-download).

In addition to this book, an extensive documentation set is available after installation. Tutorials can be found throughout the COMSOL website, including in the Learning Center at [www.comsol.com/support/learning-center](http://www.comsol.com/support/learning-center), the Video Gallery at [www.comsol.com/videos](http://www.comsol.com/videos) and on the COMSOL Blog at [www.comsol.com/blogs](http://www.comsol.com/blogs).

# COMSOL Desktop®

**MODEL MANAGER** — Click this button to switch to the Model Manager for managing different versions of your models.

**QUICK ACCESS TOOLBAR** — Use these buttons for access to functionality such as file open/save, undo/redo, copy/paste, and delete.

**APPLICATION BUILDER** — Click this button to switch to the Application Builder and start building an application based on your model.

**MODEL BUILDER TOOLBAR**

**MODEL TREE** — The model tree gives an overview of the model and all of the functionality and operations needed for building and solving a model as well as processing the results.

**MODEL BUILDER** — The Model Builder window with its model tree and the associated toolbar buttons gives you an overview of the model. The modeling process can be controlled from context-sensitive menus accessed by right-clicking a node.

**SETTINGS WINDOW** — Click any node in the model tree to see its associated Settings window displayed next to the Model Builder.

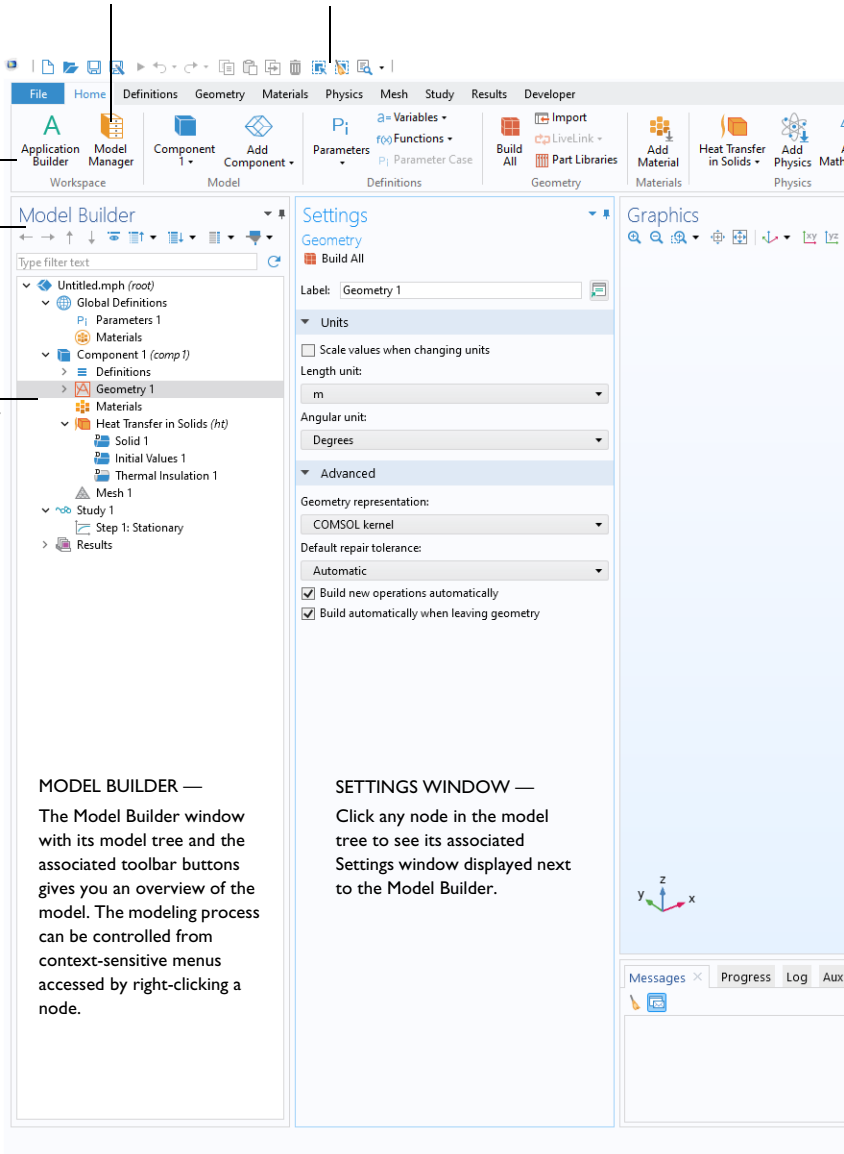

**RIBBON** — The ribbon tabs have buttons and drop-down lists for controlling all steps of the modeling process.

**GRAPHICS WINDOW TOOLBAR**

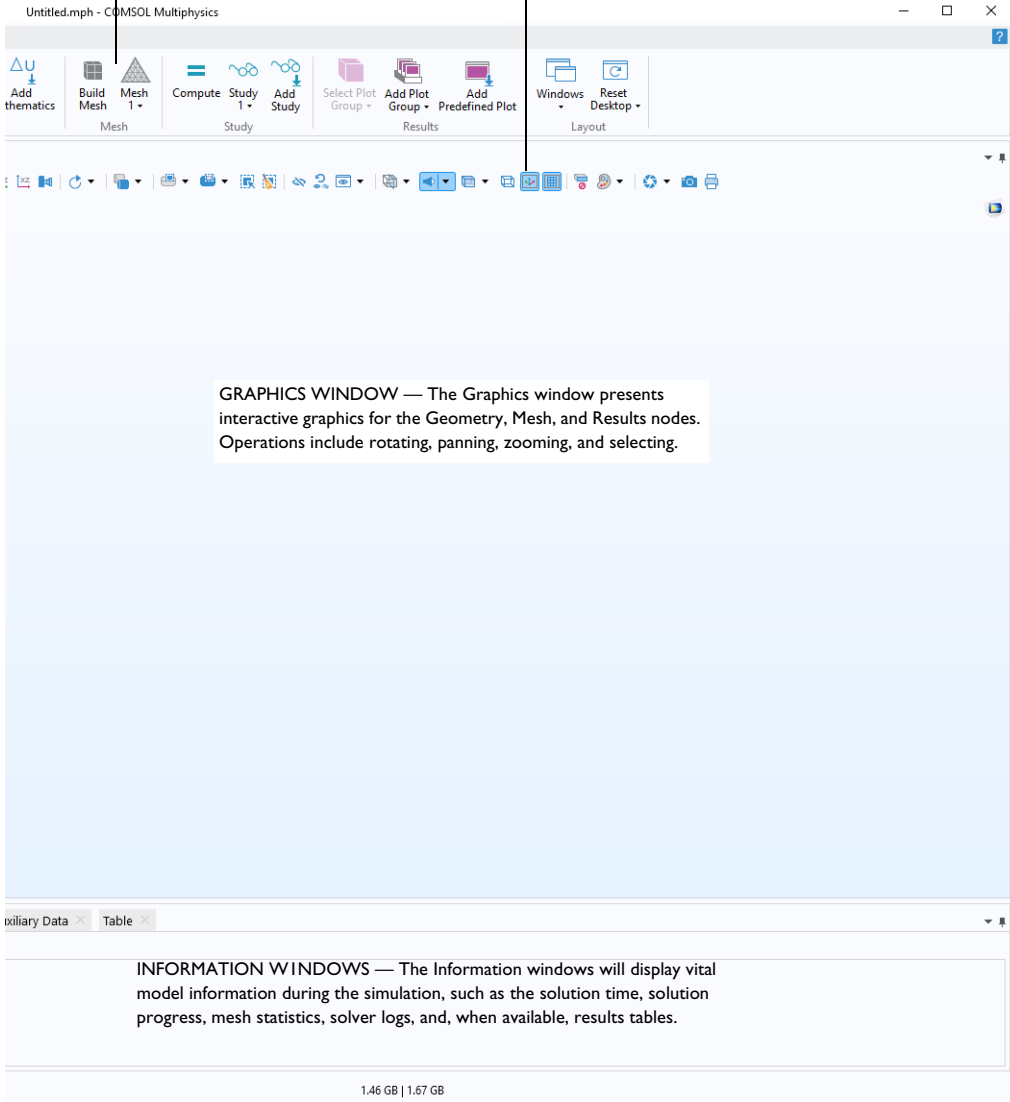

**GRAPHICS WINDOW** — The Graphics window presents interactive graphics for the Geometry, Mesh, and Results nodes. Operations include rotating, panning, zooming, and selecting.

**INFORMATION WINDOWS** — The Information windows will display vital model information during the simulation, such as the solution time, solution progress, mesh statistics, solver logs, and, when available, results tables.

The screenshot on the previous pages is what you will see when you first start modeling in COMSOL Multiphysics using the Model Builder. The COMSOL Desktop<sup>®</sup> user interface provides a complete and integrated environment for physics modeling and simulation as well as application design, providing you with the tools necessary to build a user-friendly interface for your models. You can customize the desktop to your own needs. The windows can be resized, moved, docked, and detached. Any changes you make to the layout will be saved when you close the session and available again the next time you open COMSOL Multiphysics. As you build your model, additional windows and widgets will be added. (See page 28 for an example of a more developed desktop.) Among the available windows and user interface components are the following:

### **Quick Access Toolbar**

The Quick Access Toolbar gives access to functionality such as **Open**, **Save**, **Undo**, **Redo**, **Copy**, **Paste**, and **Delete**. You can customize its content from the **Customize Quick Access Toolbar** list (the downward-facing arrow to the right of the toolbar).

### **Ribbon**

The ribbon at the top of the desktop gives access to commands used to complete most modeling tasks. The ribbon is only available in the Windows<sup>®</sup> version of the COMSOL Desktop environment and is replaced by menus and toolbars in the macOS and Linux<sup>®</sup> versions. Click the **Application Builder** button to switch from the Model Builder to the Application Builder and start building an application based on your model.

### **Settings Window**

This is the main window for entering all of the specifications of the model, including the dimensions of the geometry, properties of the materials, boundary conditions and initial conditions, and any other information that the solver will



need to carry out the simulation. The picture below shows the **Settings** window for the **Geometry** node.

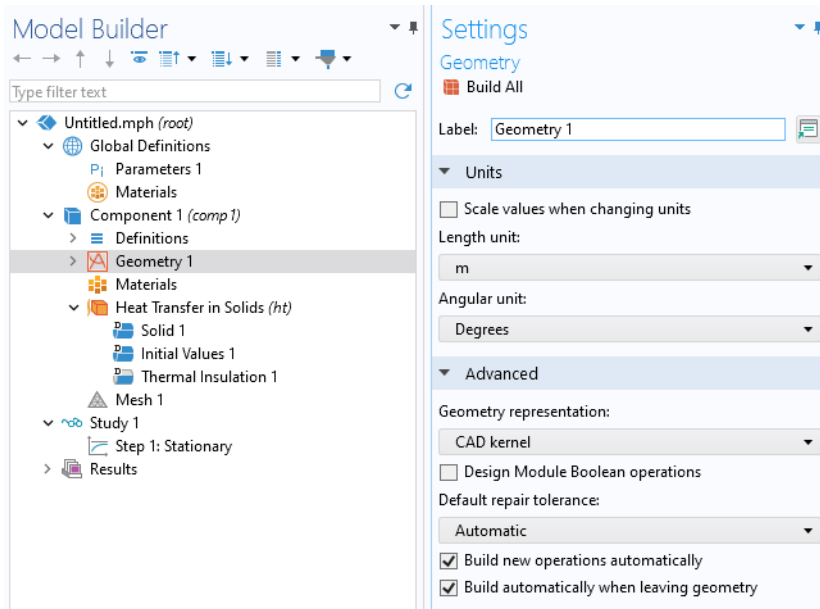

## Plot Windows

These are the windows for graphical output. In addition to the **Graphics** window, **Plot** windows are used for visualizing results. Several **Plot** windows can be used to show multiple results simultaneously. A special case is the **Convergence Plot** window, an automatically generated **Plot** window that displays a graphical indication of the convergence of the solution process while a model is running.

## Information Windows

These are the windows for nongraphical information. They include:

- **Messages:** Various information about the current COMSOL Multiphysics session is displayed in this window.
- **Progress:** Progress information from the solver in addition to stop buttons.
- **Log:** Information from the solver, such as the number of degrees of freedom, solution time, and solver iteration data.
- **Table:** Numerical data in table format as defined in the **Results** node.
- **External Process:** Provides a control panel for cluster, cloud, and batch jobs.

## Other Windows

The **Windows** drop-down list in the **Home** tab of the ribbon gives you access to all COMSOL Desktop windows. On macOS and Linux<sup>®</sup>, you will find this in the **Windows** menu. In addition to the windows described earlier, you can access the following windows:

- **Add Physics** and **Add Multiphysics**: Expand the physics interfaces in a model.
- **Add Study**: Change the type of study.
- **Add Predefined Plot**: Add a predefined plot associated with a physics interface. Predefined plots are only available for certain physics interfaces.
- **Add Material from Library** and the **Material Browser**: Access the material property libraries.
- **Application Libraries**: Choose among the collections of MPH-files containing tutorial models and runnable applications with accompanying documentation.
- **Part Libraries**: Load one of the predefined parameterized geometry models.
- **Add-in Libraries**: Load one of the add-ins that provides customized functionality.
- **Selection List**: Show a list of geometry objects, domains, boundaries, edges, and points that are currently available for selection.
- **Properties**: View model tree node properties.
- **Auxiliary Data**: View auxiliary data associated with the model such as interpolation files or CAD files.
- **Messages**: Display information after an operation is performed.
- **Debug Log**: Display debug information for methods.
- **Table**: Display results in table format.
- **External Process**: Control COMSOL Multiphysics processes running separately.
- **Comparison Result**: Compare the Model Builder and Application Builder settings of two MPH-files.
- **Find and Replace**: Enter a search string for finding it in the model's settings, tags, labels, tables, etc.
- **Versions**: Display model versions stored in a Model Manager database.
- **Recovery Files**: View recovery files.
- **Physics Builder Manager**: Compile user-defined physics interfaces. This is only visible if the Physics Builder has been activated in **Preferences**.

## Progress Bar with Cancel Button

The **Progress Bar** with a button for canceling the current computation, if any, is located in the lower right-hand corner of the COMSOL Desktop interface.

### **Dynamic Help**

The **Help** window provides context-dependent help texts about windows and model tree nodes. If you have the **Help** window open in your desktop (by typing F1, for example), you will get dynamic help (in English only) when you click a node or a window. From the **Help** window, you can search for other topics, such as menu items.

## **The Model Builder, the Application Builder, and the Model Manager**

---

The main components of the COMSOL Desktop environment are the Model Builder, the Application Builder, and the Model Manager.

### **THE MODEL BUILDER**

The Model Builder is the tool where you define the model and its components, such as how to solve it, the analysis of results, and creating reports. You do that by building a model tree. The model tree reflects the underlying data structure — the model object — which stores the state of the model including settings for geometry, mesh, physics, boundary conditions, studies, solvers, postprocessing, and visualizations.

### **THE APPLICATION BUILDER**

The Application Builder allows you to quickly create an application (also called an app) with a specialized user interface that is easy to use. An application is typically based on a model created with the Model Builder. The Application Builder provides important tools for creating applications including the Form Editor, the Main Window Editor, and the Method Editor. The Form Editor includes drag-and-drop capabilities to easily access and include user interface components, such as input fields, graphics windows, and buttons. The Main Window Editor lets you to add ribbon tabs with buttons and menus as well as organize your layout using subwindows. The Method Editor is a programming environment that, for example, allows you to modify the model represented by the model object data structure. You can also use the Method Editor to add user interface logic and auxiliary functionality to an application. The Java<sup>®</sup> programming language is used to write code in the Method Editor, which means that all Java<sup>®</sup> syntax and Java<sup>®</sup> libraries can be used.

In the Method Editor, program code is stored in methods. A method is another name for what is known in other programming languages as a subroutine, function, or procedure. Methods can be used to modify the model object data structure in the Model Builder and the Application Builder. A method can be used both for modifying the model object of the current session and for modifying the model object in a running application. For a quick introduction to the Application Builder, see “Building an Application with the Application Builder” on page 117.

## THE MODEL MANAGER

The Model Manager is a workspace for simulation data management. It allows you to collaborate with other users and centrally organize models and apps. The Model Manager provides version control to track changes and updates to your files. It will aid you in storing only relevant data of MPH-file drafts and revisions. The Model Manager includes an advanced search tool that allows you to search the models and applications stored in a Model Manager database for contents based on keywords or tags. Depending on your license type, you can connect to a local or remote and centrally managed Model Manager database. For a quick introduction to the Model Manager, see “Using the Model Manager” on page 188.

## FURTHER READING

This book, *Introduction to COMSOL Multiphysics*, gives a detailed introduction to using the Model Builder and a quick introduction to the Application Builder and the Model Manager. For detailed information on how to use the Application Builder, see *Introduction to Application Builder* and the *Application Programming Guide*. For more information on the Model Manager, see the *Reference Manual* and the *Model Manager Manual*.

## Applications, COMSOL Server™, and COMSOL Compiler™

---

The Application Builder is included in the Windows® version of COMSOL Multiphysics. With a COMSOL Multiphysics license, apps can be run from the COMSOL Desktop environment. Although applications cannot be built with the macOS or Linux® versions of the software, applications can still be run with COMSOL Multiphysics on those platforms.

By using COMSOL Compiler™ you can compile your application (MPH-file) to an executable file for Windows®, Linux®, and macOS. You can freely distribute the executable and it can be run without any license file.

With a COMSOL Server™ license, applications can be run in major web browsers on a variety of operating systems and hardware platforms. In addition, you can run applications by connecting to COMSOL Server with an easy-to-install COMSOL Client for Windows®.

The COMSOL Client for Windows® allows a user to run applications that require a LiveLink™ product for CAD (this functionality is not available when running applications with a web browser).

Running applications in a web browser does not require any installation and no web browser plug-ins are needed. Running an application in a web browser supports interactive graphics in 1D, 2D, and 3D. In a web browser, graphics rendering in 3D are based on WebGL™ technology, which comes with all major web browsers. In addition, there is a COMSOL Client version for Android® available in the Google Play™ store.

To create an application based on your model, click the **Application Builder** button, accessible from the **Home** tab on the ribbon.

For more information on creating COMSOL applications, refer to the section “Building an Application with the Application Builder” on page 117 and the book *Introduction to Application Builder*.

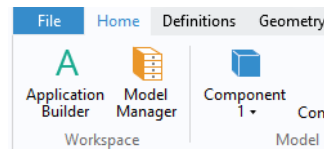

## Preferences

---

Preferences are settings that affect the modeling environment. Most are persistent between modeling sessions, but some are saved with the model. You access the preferences from the **File** menu by selecting **Preferences**.

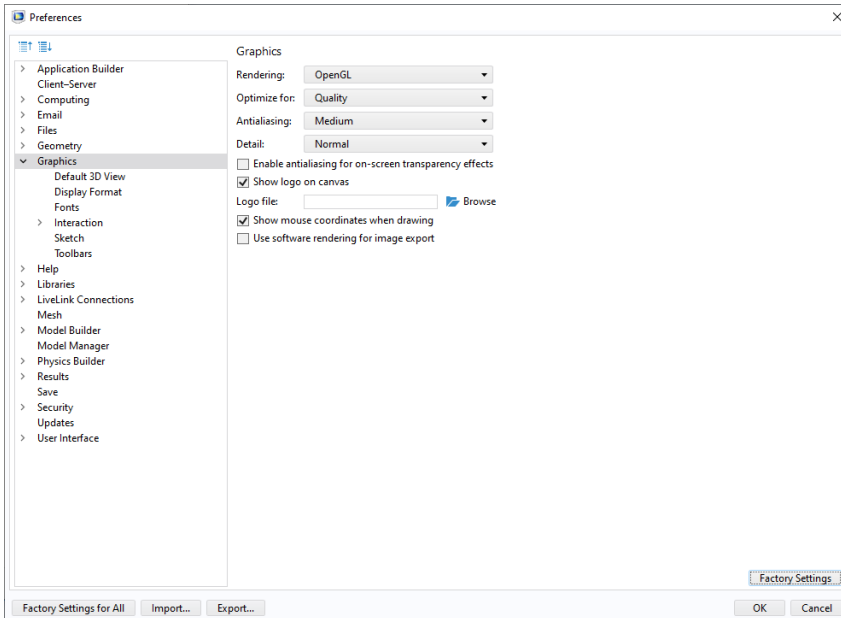

In the **Preferences** window, you can change settings such as graphics rendering, the number of displayed digits for results, the maximum number of CPU cores used for computations, or paths to user-defined application libraries. Take a moment to browse your current settings to familiarize yourself with the different options.

### GRAPHICS AND PLOT WINDOWS

In the **Graphics** page, there are two graphics rendering options available: **OpenGL**<sup>®</sup> and **Software Rendering**. If your computer does not have a dedicated graphics card, you may have to switch to **Software Rendering** for slower but fully functional graphics. A list of recommended graphics cards can be found at:

[www.comsol.com/system-requirements](http://www.comsol.com/system-requirements)

## COLOR THEMES

In the **User Interface > Color Themes** page, there are three color theme preferences:

- **Desktop color theme:** Choose between a **Default**, **Light**, or **Dark** theme for the COMSOL Desktop environment.
- **Graphics color theme:** Choose a color theme for the **Graphics** window.
- **Image export color theme:** Choose a color theme for exported images.

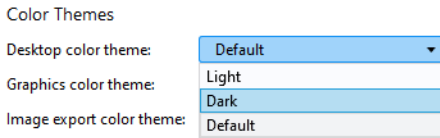

When using the **Dark** theme in Linux<sup>®</sup>, some controls take their color from the operating system's theme. You will get a better user experience by picking both a dark-looking theme in Linux<sup>®</sup> and the **Dark** theme in the COMSOL Desktop environment.

## Opening and Saving Files from the File Menu

The **File** menu provides several options for opening and saving model files on the COMSOL MPH-file format, as well as a few other supported formats.

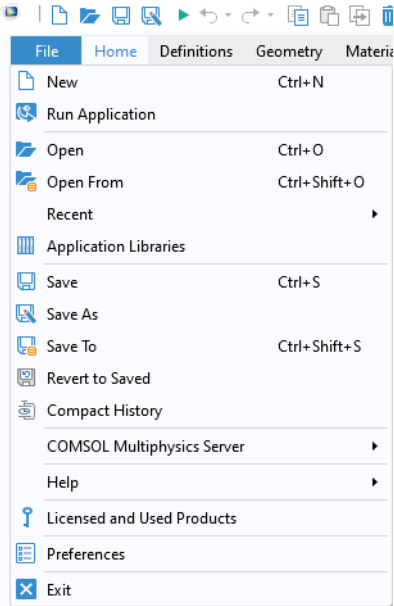

- **New** lets you create a new model from scratch.
- **Run Application** opens and runs an application if a runnable application definition is available in the chosen MPH-file.
- **Open** opens an existing file from the file system using the **Open** dialog box.

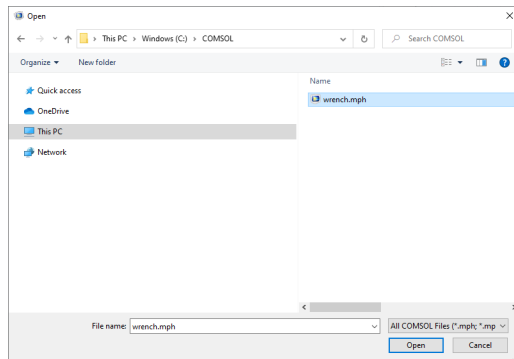



- **Open From** opens an existing file from either the file system or from a Model Manager database (see “Using the Model Manager” on page 188).

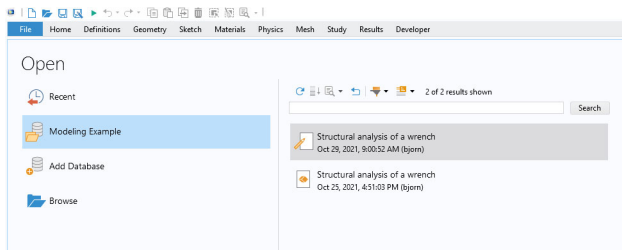

- **Recent** opens a recently opened file from the file system or from a Model Manager database.
- **Application Libraries** opens a tutorial model or a runnable application from the Application Libraries.
- **Save** saves the current file.
- **Save As** lets you save the current file to the file system with a new name using the **Save As** dialog box.

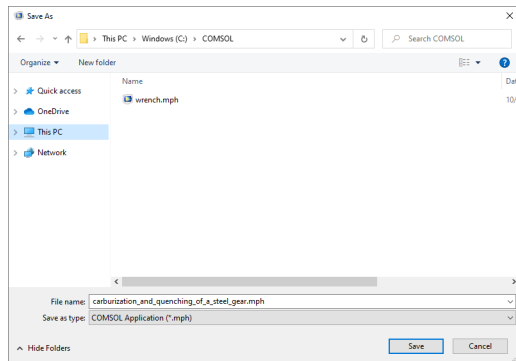

- **Save To** lets you save to a Model Manager database.

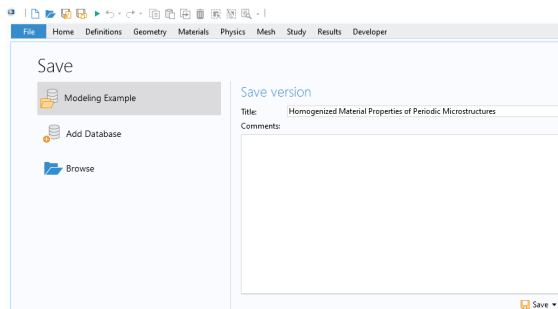

- **Revert to Saved** opens the last saved version of the file and reinitializes the user interface.

## Creating a New Model

---

You can set up a model guided by the **Model Wizard** or start from a **Blank Model** as shown in the figure below.

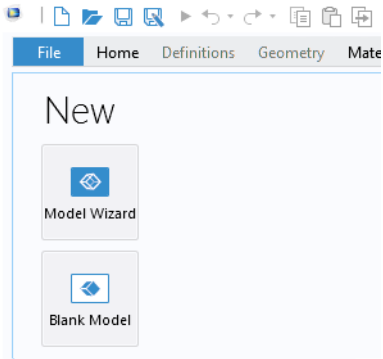

### CREATING A MODEL GUIDED BY THE MODEL WIZARD

The Model Wizard will guide you in setting up the space dimension, physics, and study type in a few steps:

- 1 Start by selecting the space dimension for your model component: **3D**, **2D Axisymmetric**, **2D**, **1D Axisymmetric**, **1D**, or **0D**.

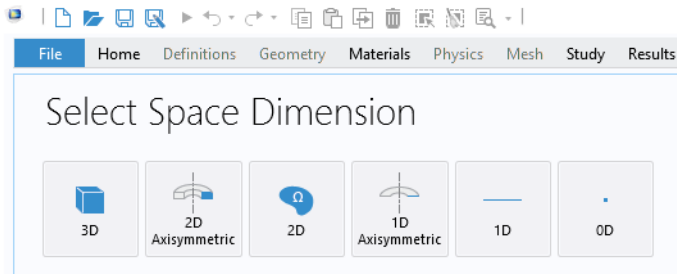

- 2 Now, add one or more physics interfaces. These are organized in a number of physics branches in order to make them easy to locate. These branches do not directly correspond to products. When products are added to your COMSOL

Multiphysics installation, one or more branches will be populated with additional physics interfaces.

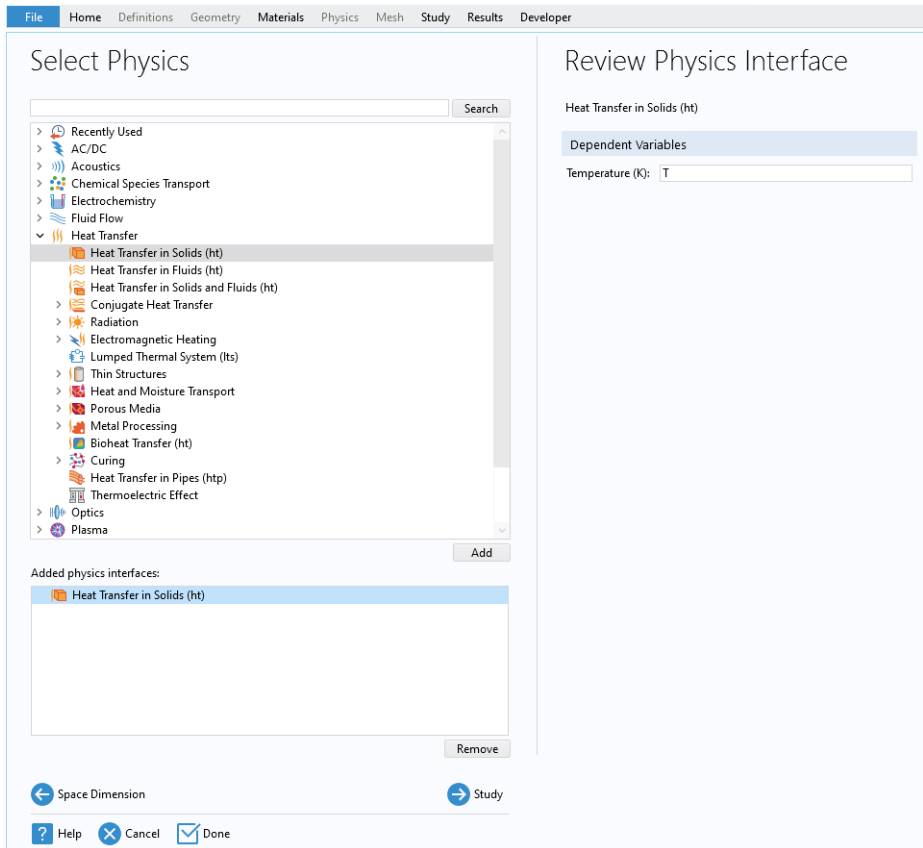

- 3 Select the **Study** type that represents the solver or set of solvers that will be used for the computation.

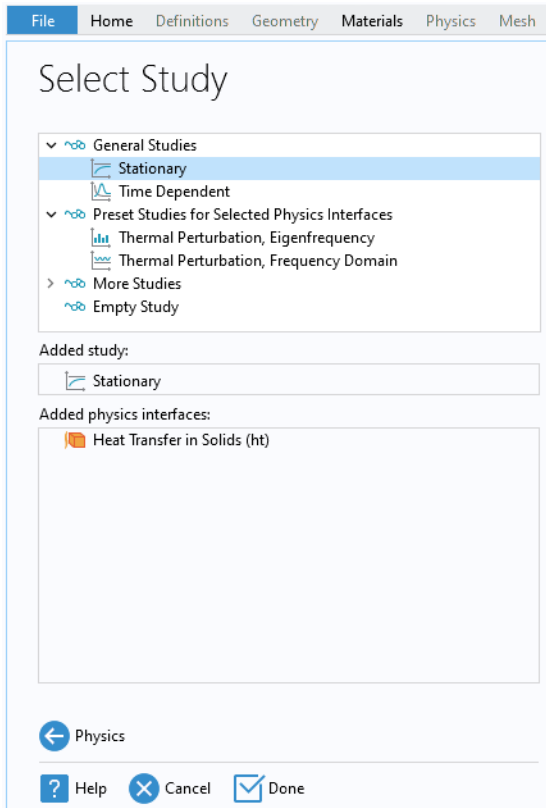

Finally, click **Done**. The desktop is now displayed with the model tree configured according to the choices you made in the Model Wizard.

## CREATING A BLANK MODEL

The **Blank Model** option will open the COMSOL Desktop interface without any **Component** or **Study**. You can right-click the model tree to add a **Component** of a certain space dimension, physics interface, or **Study**.

# The Ribbon, Quick Access Toolbar, and Graphics Menus

The ribbon tabs in the COMSOL Desktop environment reflect the modeling workflow and give an overview of the functionality available for each modeling step, including building simulation applications from your models.

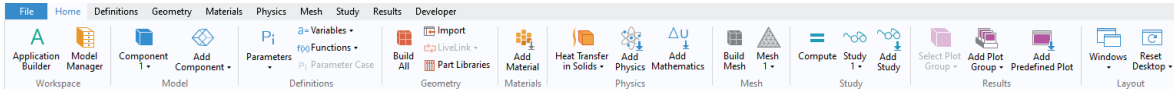

The **Home** tab contains buttons for the most common operations for making changes to a model, running simulations, and for building and testing applications. Examples include changing model parameters for a parameterized geometry, reviewing material properties and physics, building the mesh, running a study, and visualizing the simulation results.

There are standard tabs for each of the main steps in the modeling process. These are ordered from left to right according to the workflow: **Definitions, Geometry, Materials, Physics, Mesh, Study, Results, and Developer.**

Contextual tabs are shown only if they are needed, such as the **3D Plot Group** tab, which is shown when the corresponding plot group is added or when the node is selected in the model tree.

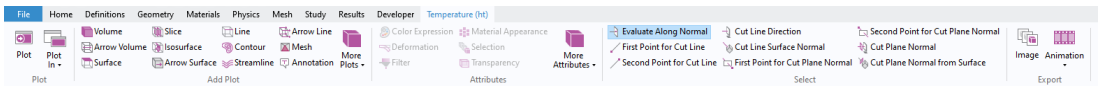

Modal tabs are used for very specific operations, when other operations on the ribbon may become temporarily irrelevant. An example is the **Work Plane** modal tab. When working with work planes, other tabs are not shown, since they do not present relevant operations.

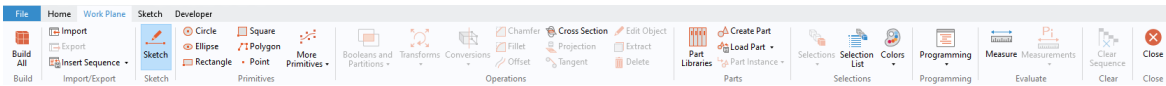

## THE RIBBON VS. THE MODEL BUILDER

The ribbon gives quick access to available commands and complements the model tree in the **Model Builder** window. Most of the functionality accessed from the ribbon is also accessible from contextual menus by right-clicking nodes in the model tree. Certain operations are only available from the ribbon, such as selecting which desktop window to display. In the COMSOL Desktop interface for macOS and Linux<sup>®</sup>, this functionality is available from toolbars, which replace the ribbon on these platforms. There are also operations that are only available from the model tree, such as reordering and disabling nodes.

## THE QUICK ACCESS TOOLBAR

The **Quick Access Toolbar** contains a set of commands that are independent of the ribbon tab that is currently displayed. You can customize the **Quick Access Toolbar** and add most commands available in the **File** menu, including commands for undoing and redoing recent actions, as well as for copying, pasting, duplicating, and deleting nodes in the model tree. You can also choose to position the **Quick Access Toolbar** above or below the ribbon.



## THE GRAPHICS MENUS

As an alternative to using the model tree or the ribbon, you can right-click in the **Graphics** window to access context-dependent menus. The menu shown will depend on which node is currently selected in the model tree. By using the **Go To** option, when available, you can jump to a context menu for another node in the model tree.

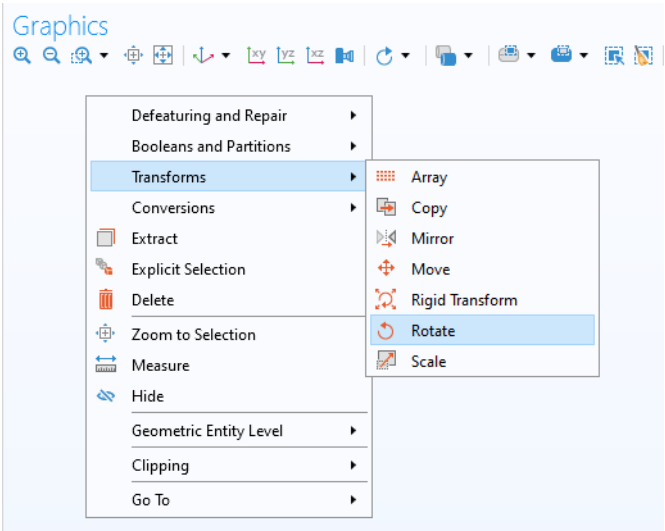

## MACOS AND LINUX<sup>®</sup>

In the COMSOL Desktop environment for macOS and Linux<sup>®</sup>, the ribbon is replaced by a set of menus and toolbars.

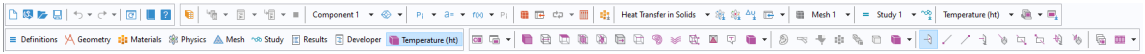

The instructions in this book are based on the Windows<sup>®</sup> version of the COMSOL Desktop environment. However, running COMSOL Multiphysics and the COMSOL Desktop environment in macOS and Linux<sup>®</sup> is very similar, keeping in mind that the ribbon user interface components can instead be found in the corresponding menus and toolbars. In addition, the Application Builder is only available in the Windows<sup>®</sup> version. However, you can run apps in all supported operating systems.

## The Model Builder and the Model Tree

---

Using the Model Builder, you build a model by starting with the default model tree, adding nodes, and editing the node settings.

All of the nodes in the default model tree are top-level parent nodes. You can right-click on them to see a list of child nodes, or subnodes, that you can add beneath them. This is the means by which nodes are added to the tree.

When you click on a child node, you will see its node settings in the **Settings** window. It is here that you can edit node settings.

It is worth noting that if you have the **Help** window open, which is achieved either by selecting **Help** from the **File** menu or by pressing the function key F1, then you will also get dynamic help (in English only) when you click on a node.

### THE ROOT, GLOBAL DEFINITIONS, AND RESULTS NODES

A model tree always has a root node (initially labeled *Untitled.mph*), a **Global Definitions** node, and a **Results** node. The label on the root node is the name of the multiphysics model file, or MPH-file, to which the model is saved. The root node has settings for author name, default unit system, and more.

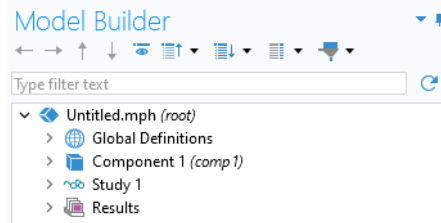

The **Global Definitions** node has a **Parameters** and a **Materials** subnode by default. The **Global Definitions** node is where you can, among other things, define parameters, variables, functions, and couplings that can be used throughout the

model tree. They can be used, for example, to define the values and functional dependencies of material properties, forces, geometry, and other relevant features. The **Global Definitions** node itself has no settings, but its child nodes have plenty of them. The **Materials** subnode stores material properties that can be referenced in the **Component** nodes of a model.

The **Results** node is where you access the solution after performing a simulation and where you find tools for processing the data. The **Results** node initially has five subnodes:

- **Datasets**, which contains a list of solutions you can work with.
- **Derived Values**, which defines values to be derived from the solution using a number of postprocessing tools.
- **Tables**, which is a convenient destination for the **Derived Values** or for **Results** generated by probes that monitor the solution in real-time while the simulation is running.
- **Export**, which defines numerical data, images, and animations to be exported to files.
- **Reports**, which collects reports about the model in the HTML, Microsoft® Word, and Microsoft® PowerPoint formats.

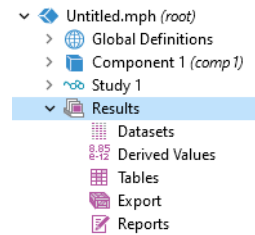

To these five default subnodes, you may also add more **Plot Group** subnodes that define graphs to be displayed in the **Graphics** window or in **Plot** windows. Some of these may be created automatically, depending on the type of simulations you are performing, but you may include additional figures by right-clicking on the **Results** node and choosing from the list of plot types. In addition, you can add an **Evaluation Group** node, which is similar to the **Derived Values** node but with tightly associated **Evaluation Group** tables, and a **Parameters** node for parameters used exclusively in **Results**.

## THE COMPONENT AND STUDY NODES

In addition to the three nodes just described, there are two additional top-level node types: **Component** nodes and **Study** nodes. These are usually created by the Model Wizard when you start a new model. After using the Model Wizard to specify what type of physics you are modeling and what type of **Study** (for example, steady-state, time-dependent, frequency-domain, or eigenfrequency analysis) you

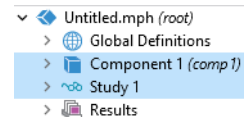



will carry out, the Model Wizard automatically creates one node of each type and shows you their contents.

It is also possible to add more **Component** and **Study** nodes as you develop the model. A model can contain multiple **Component** and **Study** nodes and it would be confusing if they all had the same name. Therefore, these types of nodes can be renamed to be descriptive of their individual purposes.

If a model has multiple **Component** nodes, they can be coupled to form a more sophisticated sequence of simulation steps.

Note that each **Study** node may carry out a different type of computation, so each one has a separate **Compute** button = .

To be more specific, suppose that you build a model that simulates a coil assembly that is made up of two parts: a coil and a coil housing. You can create two **Component** nodes: one that models the coil and another that models the coil housing. You can then rename each of the nodes with the name of the object. Similarly, you can also create two **Study** nodes, the first simulating the stationary or steady-state behavior of the assembly, and the second simulating the frequency response. You can rename these two nodes to be **Stationary** and **Frequency Domain**. When the model is complete, save it to a file named `Coil Assembly.mph`. At that point, the model tree in the Model Builder looks like the figure below.

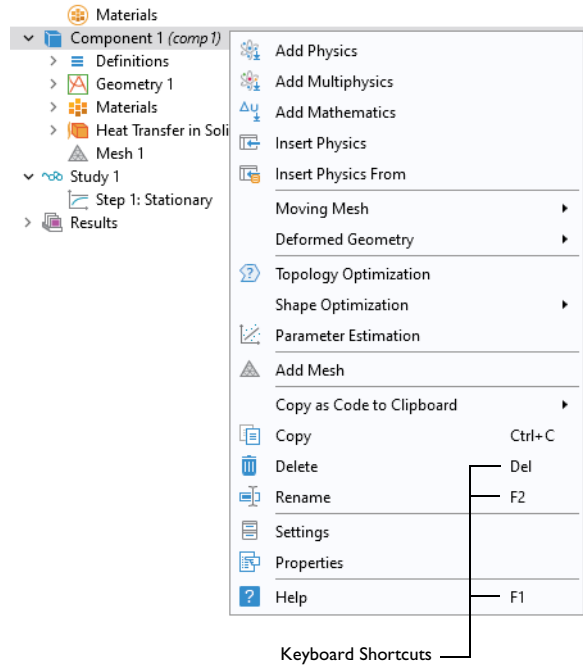

In this figure, the root node is named `Coil Assembly.mph`, indicating the file in which the model is saved. The **Global Definitions** node and the **Results** node each have their default name. Additionally, there are two **Component** nodes and two **Study** nodes with the names chosen in the previous paragraph.

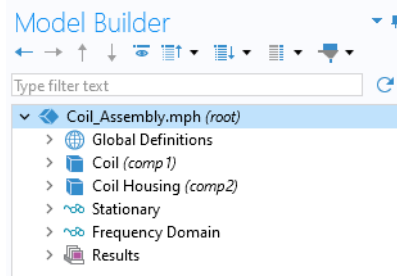

## PARAMETERS, VARIABLES, AND SCOPE

### *Global Parameters*

Global parameters are user-defined constant scalars that are usable throughout the model. That is to say, they are “global” in nature. Important uses are:

- Parameterizing geometric dimensions.
- Specifying mesh element sizes.
- Defining parametric sweeps (simulations that are repeated for a variety of different values of a parameter such as a frequency or load).

A global parameter expression can contain numbers, global parameters, built-in constants, built-in and user-defined functions with global parameter expressions as arguments, and unary and binary operators. For a list of available operators, see “Appendix C — Language Elements and Reserved Names” on page 239. Because these expressions are evaluated before a simulation begins, global parameters cannot depend on the time variable,  $t$ . Likewise, they cannot depend on spatial variables like  $x$ ,  $y$ , or  $z$ , nor on the dependent variables for which your equations are solving.

It is important to know that the names of parameters are case sensitive.

You define global parameters in the **Parameters** node in the model tree under **Global Definitions**.

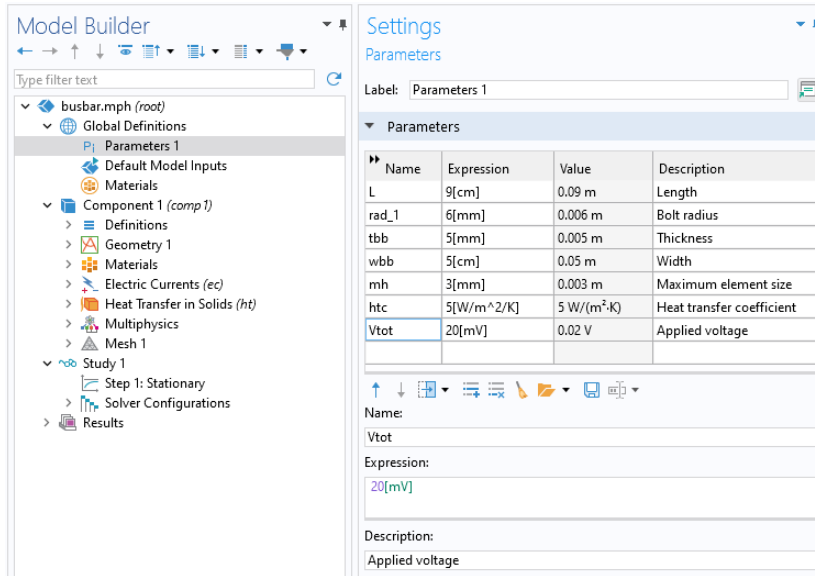

Note that you can add multiple **Parameters** nodes and they will be named **Parameters 1**, **Parameters 2**, etc. In addition, **Parameters** can be organized into several cases and then swept over. For more information, see “Parametric Sweeps” on page 169.

The following spread shows an example of a customized desktop with additional windows.

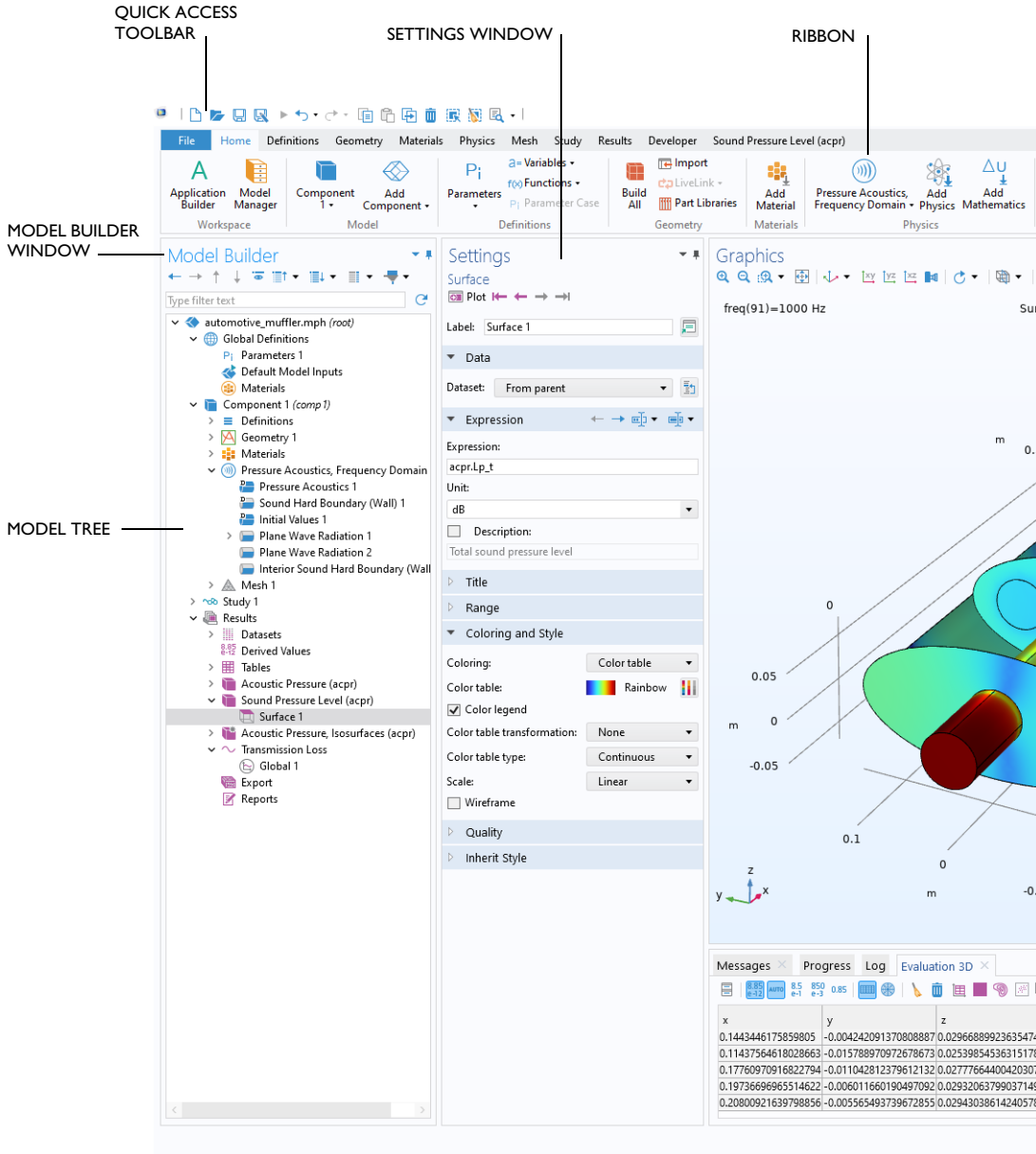

GRAPHICS WINDOW

DYNAMIC HELP — Continuously updated with online access to the Knowledge Base and Application Gallery. The Help window enables easy browsing with extended search functionality.

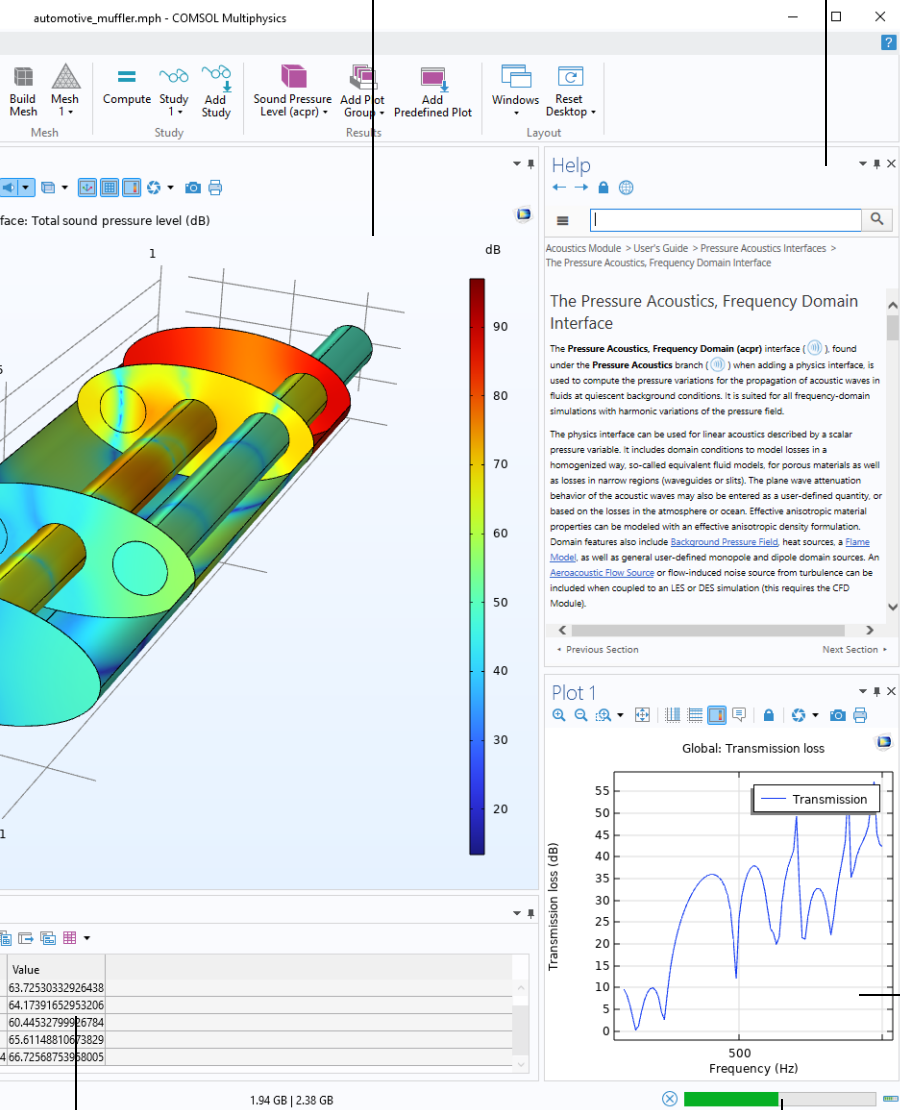

INFORMATION WINDOWS

PROGRESS BAR WITH CANCEL BUTTON

PLOT WINDOW — The Plot window is used to visualize Results quantities, probes, and convergence plots. Several Plot windows can be used to show multiple results simultaneously.

## Results Parameters

For greater flexibility, it is possible to define parameters that are only used in the **Results** node. Using these parameters does not require resolving the model.

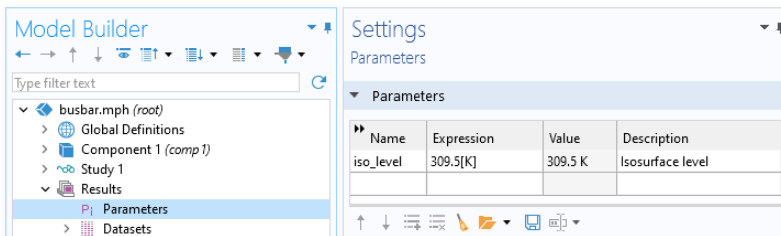

Result parameters may depend on other parameters and built-in functions.

## Variables

Variables have associated **Variables** nodes in the model tree and can be defined either in the **Global Definitions** node or in the **Definitions** subnode of any **Component** node.

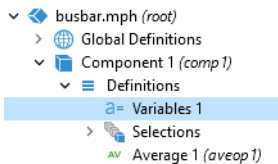

Naturally, the choice of where to define the variable depends on whether you want it to be global (that is, usable throughout the model tree) or locally defined within a single **Component** node. Like a parameter expression, a variable expression may contain numbers, parameters, built-in constants, and unary and binary operators. However, it may also contain variables like  $t$ ,  $x$ ,  $y$ , or  $z$ ; functions with variable expressions as arguments; and dependent variables that you are solving for, such as temperature  $T$  or voltage  $V$ , in addition to their space and time derivatives.

If you have a model with many **Variables** nodes it may be useful to group them together by using the **Node Group** feature, as shown below. You access this menu by right-clicking the **Definitions** node.

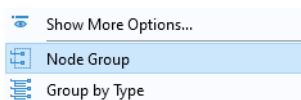

Node groups can be used to group nodes in **Global Definitions**, **Definitions** under a **Component**, **Geometry**, **Materials**, physics interfaces, and results.

## *Variables Used in Applications*

Model parameters and variables can be used in applications. For example, you can let the user of an application change the value of a parameter. In addition, variables to be used in applications can be defined in the Application Builder, in the application tree under the **Declarations** node. Such variables can also be used in model methods.

### *Scope*

The “scope” of a parameter or variable is a statement about where it may be used in an expression. All global parameters are defined in the **Global Definitions** node of the model tree as a **Parameters** subnode. This means that they are global in scope and can be used throughout the model tree.

A variable may also be defined in the **Global Definitions** node, as a **Variables** subnode, and have global scope, but they are subject to other limitations. For example, variables may not be used in **Geometry**, **Mesh**, or **Study** nodes (with the one exception that a variable may be used in an expression that determines when the simulation should stop).

A variable that is instead defined under the **Definitions** subnode of a **Component** node has local scope and is intended for use in that particular **Component** (but, again, not in the **Geometry** or **Mesh** nodes). They may be used, for example, to specify material properties in the **Materials** subnode of a **Component** or to specify boundary conditions or interactions. It is sometimes valuable to limit the scope of the variable to only a certain part of the geometry, such as certain boundaries. For that purpose, provisions are available in the settings for a variable to select whether to apply the definition either to the entire geometry of the **Component** or only to a **Domain**, **Boundary**, **Edge**, or **Point**.

The figure below shows the definition of two variables,  $q_{pin}$  and  $R$ , for which the scope is limited to just two boundaries identified by numbers 15 and 19.

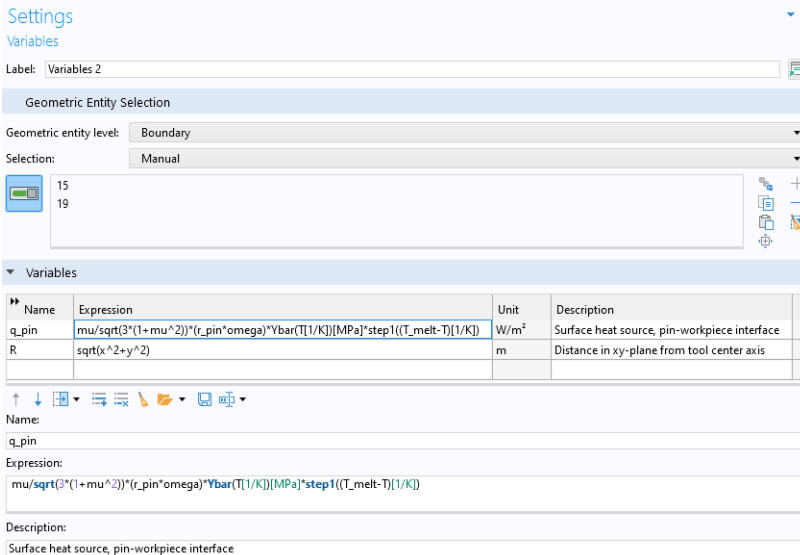

Such a group of numbers is called a **Selection** and can be named and then referenced elsewhere in a model. This can be useful, for example, when defining material properties or boundary conditions that will use the variable at certain boundaries but not elsewhere. To give a name to the **Selection**, click the **Create Selection** button (  ) to the right of the **Selection** list.

Although the variables defined in the **Variables** node under the **Component > Definitions** subnode are intended to have local scope, they can still be accessed outside of the **Component** node in the model tree by being sufficiently specific about their identity. This is done by using a “dot notation”, where the variable name is preceded by the name of the **Component** node in which it is defined and the names are joined by a “dot”. In other words, if a variable named  $f_{oo}$  is defined in a **Component** node named  $MyMode1$ , then this variable can be accessed outside of the **Component** node by using  $MyMode1.f_{oo}$ . This can be useful, for example, when you want to use the variable to make plots in the **Results** node. Variables defined under the **Declarations** node in the Application Builder are available globally in form objects and methods but cannot be used in the Model Builder.



## Built-In Constants, Variables, and Functions

---

COMSOL Multiphysics comes with many built-in constants, variables, and functions. They have reserved names that cannot be redefined by the user. If you use a reserved name (a name already used by the software) for a user-defined variable, parameter, or function, the text you enter will get a yellow squiggly underline (indicating a warning) or a red squiggly underline (indicating an error) and you will get a tooltip message if you hover over the text string.

Some important examples are:



- Mathematical constants such as  $\pi$  (3.14...) or the imaginary unit  $i$  or  $j$
- Physical constants such as  $g\_const$  (acceleration of gravity),  $c\_const$  (speed of light), or  $R\_const$  (universal gas constant)
- The time variable,  $t$
- First- and second-order derivatives of the dependent variables (the solution) whose names are derived from the spatial coordinate names and dependent variable names (which are user-defined variables)
- Mathematical functions such as  $\cos$ ,  $\sin$ ,  $\exp$ ,  $\log$ ,  $\log_{10}$ , and  $\sqrt{\quad}$

See “Appendix C — Language Elements and Reserved Names” on page 239 for more information.



## The Application Libraries

---

The Application Libraries are collections of MPH-files containing tutorial models and runnable applications with accompanying documentation. Tutorial models show how to use the Model Builder and have documentation that includes theoretical background and step-by-step instructions. Runnable applications have instructions on how to use the application. You can readily inspect and edit all tutorial models and applications to make them your own. Each physics-based add-on module comes with its own application library with examples specific to its applications and physics area. You can use the step-by-step instructions and the MPH-files as a template for your own modeling.

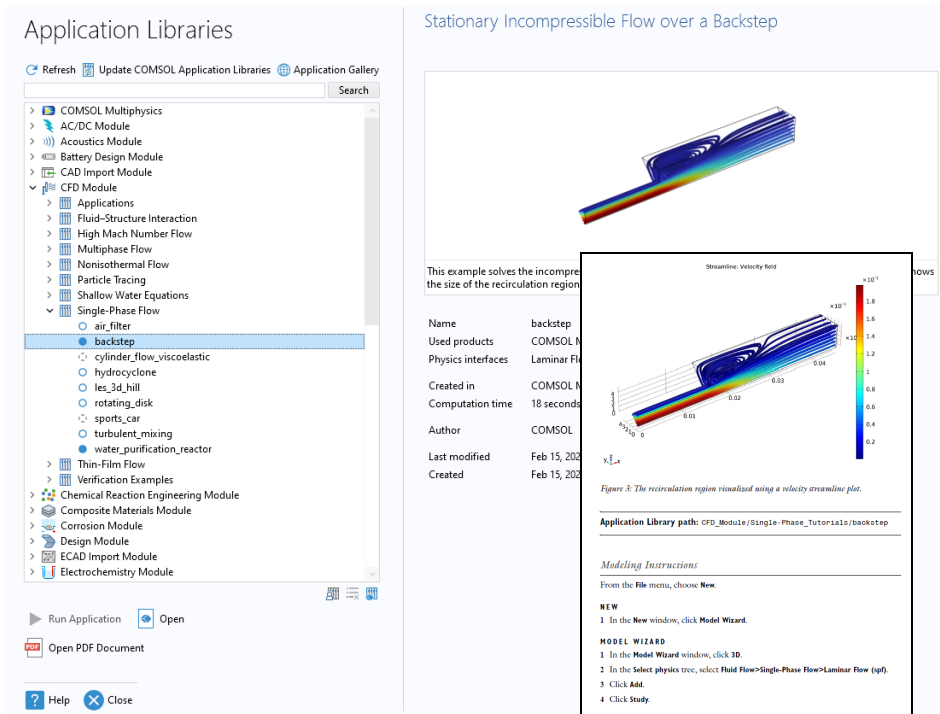
To open the **Application Libraries** window, select **Application Libraries**  from the **Windows** menu on the **Home** toolbar or from the **File** menu . Then, search by application name or browse under a module folder name.





Click **Open** , **Run Application** , or **Open PDF Document** . Alternatively, select **Help > Documentation** from the **File** menu to search by application name or browse by module. Note that the **Run Application** option is only available for MPH-files that are runnable applications.

The MPH-files in the Application Libraries can have three formats — Solved MPH-files, Compact MPH-files, or Preview MPH-files:

- Solved MPH-files, including all meshes and solutions. In the **Application Libraries** window, these appear with the  icon. If the MPH-file size exceeds 25 MB, a tooltip with the text **Large file** and the file size appears when you position the cursor at the model's node in the Application Libraries tree.
- Compact MPH-files, with all settings for the model but without built meshes and solution data to save space in the installation. Some MPH-files have no solutions for other reasons such that the computation time is short and the results are easily regenerated. You can open these to study the

settings and to mesh and re-solve. It is also possible to download the full versions — with meshes and solutions — of most of these when you update your Application Libraries. These appear in the Application Libraries window with the  icon. If you position the cursor at a compact file in the **Application Libraries** window, a **No solutions stored** message appears. A solved version is available for download via the Application Library Update (except in a few cases where the file is a template related to another, regular, model).

- Preview MPH-files, with only a model description and thumbnail image available. These appear in the **Application Libraries** window with the  icon. The file is a preview of an application or a model file, including the model description and information about used products and physics interfaces and the computation time. Solved and compact versions are available for download. Model documentation will be available if you have specified the use of online help (see the *Reference Manual* for details on how to do this).

The Application Libraries are updated on a regular basis by COMSOL. To check all available updates, click **Update COMSOL Application Libraries**  at the top of the **Application Libraries** window. You can also find this option from the **File > Help** menu (Windows<sup>®</sup> users) or from the **Help** menu (macOS and Linux<sup>®</sup> users). This connects you to the COMSOL website, where you can access new applications and the latest updates.

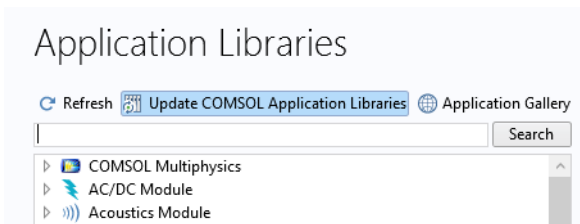

If your computer has internet connection, then you can click the **Application Gallery** button to access a wide range of additional examples from the COMSOL website.

## Workflow and Sequence of Operations

---

In the **Model Builder** window, every step of the modeling process, from defining global variables to the final report of results, is displayed in the model tree.

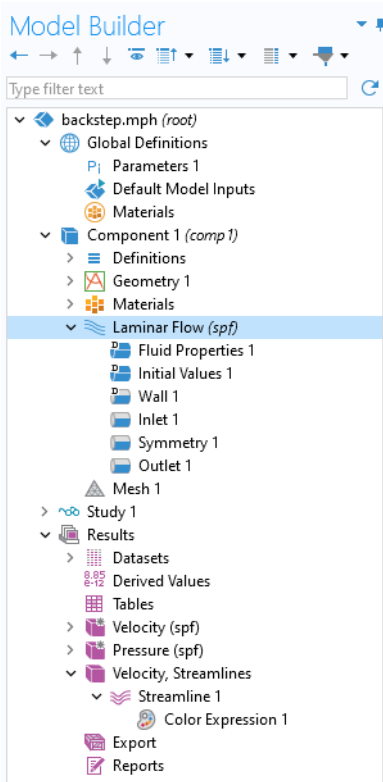

From top to bottom, the model tree defines an orderly sequence of operations.

In the following branches of the model tree, the node order makes a difference and you can change the sequence of operations by moving the subnodes up or down the model tree:

- **Geometry**
- **Materials**
- **Physics**
- **Mesh**
- **Study**
- **Plot Groups**

Nodes may be reordered by these methods:

- Drag-and-drop
- Right-clicking the node and selecting **Move Up** or **Move Down**
- Pressing Ctrl + Up arrow or Ctrl + Down arrow

In other branches, the ordering of nodes is not significant with respect to the sequence of operations, but some nodes can be reordered for readability. Child nodes to **Global Definitions** is one such example. You can use the filter text field above the model tree to display only those nodes that match the search string you enter here. The **Filter Options** menu, available in the Model Builder toolbar, has additional settings for modifying the search results.

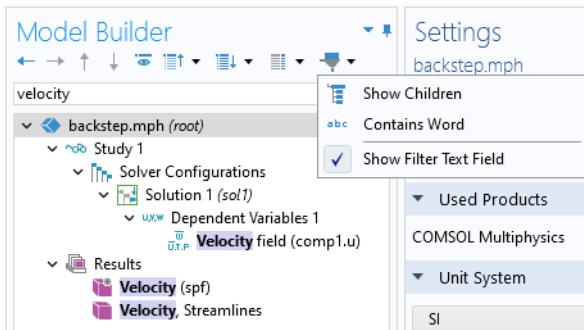

You can view the sequence of operations presented in the model tree as program code statements by saving the model as a **Model File for MATLAB<sup>®</sup>** or as a **Model File for Java<sup>®</sup>** after having selected **Compact History** in the **File** menu. Note that the model history keeps a complete record of the changes you make to a model as you build it. As such, it includes all of your corrections, including changes to parameters and boundary conditions and modifications of solver methods. Compacting this history removes all of the overridden changes and leaves a clean copy of the most recent form of the model steps. In the Application Builder, you can use the **Record Method** option to view and edit program code statements in the Method Editor.

As you work with the COMSOL Desktop interface and the Model Builder, you will grow to appreciate the organized and streamlined approach. However, any description of a user interface is inadequate until you try it for yourself. In the next chapters, you are invited to work through two examples to familiarize yourself with the software.

## Example 1: Structural Analysis of a Wrench

---

This simple example requires none of the add-on products to COMSOL Multiphysics®. For more fully featured structural mechanics models, see the Structural Mechanics Module application library.

At some point in your life, it is likely that you have tightened a bolt using a wrench. This exercise takes you through a structural mechanics model that analyzes this basic task from the perspective of the structural integrity of the wrench subjected to a worst-case loading.

The wrench is, of course, made from steel, a ductile material. If the applied torque is too high, the tool will be permanently deformed due to the steel's elastoplastic behavior when pushed beyond its yield stress level. To analyze whether the wrench handle is appropriately dimensioned, you will check if the mechanical stress level is within the yield stress limit.

This tutorial gives a quick introduction to the Model Builder workflow. It starts with opening the Model Wizard and adding a physics option for solid mechanics. Then a geometry is imported and steel is selected as the material. You then explore the other key steps in creating a model by defining a parameter and boundary condition for the load; selecting geometric entities in the Graphics window; defining the Mesh and Study; and finally, examining the results numerically and through visualization.

If you prefer to practice with a more advanced model, read this section to familiarize yourself with some of the key features, and then go to the tutorial “Example 2: The Busbar — A Multiphysics Model” on page 75.

## Model Wizard

---

- 1 To start the software, double-click the COMSOL Multiphysics icon on the desktop, which will take you to the **New** window with two options for creating a new model: **Model Wizard** or **Blank Model**.



If you select **Blank Model**, you can right-click the root node in the model tree to manually add a **Component** and a **Study**. For this tutorial, click the **Model Wizard** button.

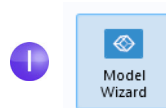

If the COMSOL Desktop user interface is already open, you can start the Model Wizard by selecting **New** from the **File** menu. Choose the **Model Wizard**.

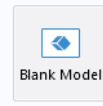

The Model Wizard will guide you through the first steps of setting up a model. The next window lets you select the dimension of the modeling space.

- 2 In the **Select Space Dimension** window, select 3D.

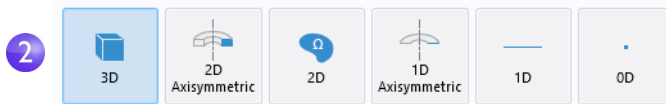

3 In **Select Physics**, select **Structural Mechanics > Solid Mechanics (solid)** . Click **Add**.

Even without add-on modules, the **Solid Mechanics** interface is available in the **Structural Mechanics** folder. In the picture to the right, part of the **Structural Mechanics** folder is shown as it appears when all add-on modules are available.

Click **Study** to continue.

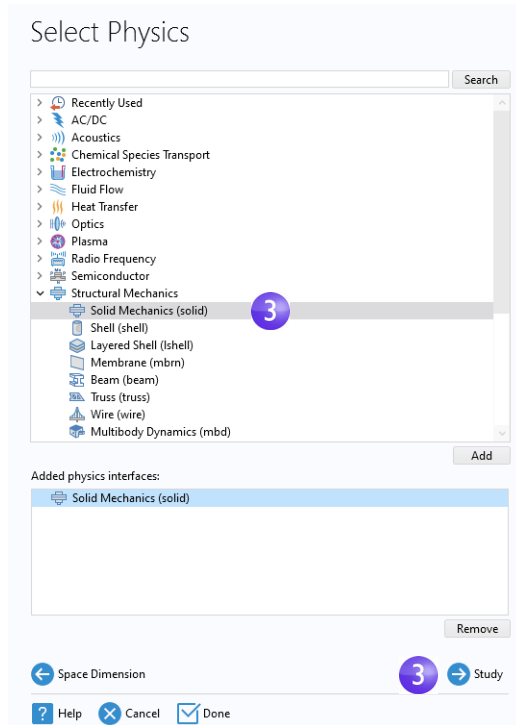

4 Click **Stationary** under **General Studies**. Click **Done** once you have finished.

**General Studies** and other preset studies have solver and equation settings adapted to the selected physics, which is, in this example, **Solid Mechanics**. A **Stationary** study is used in this case — there are no time-varying loads or material properties.

Any selection from the **More Studies** branch requires manual settings.

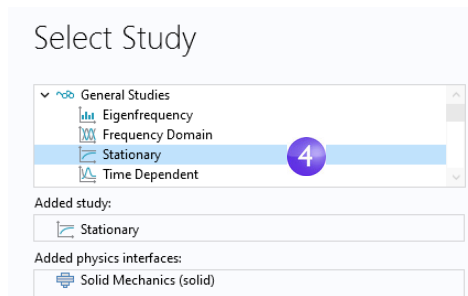



## Geometry

---

This tutorial uses a geometry that was previously created and stored in the COMSOL native CAD format, .mphbin. To learn how to build your own geometry, see “Appendix A — Building a Geometry” on page 214.

The location of the Application Library that contains the file used in this exercise varies based on the software installation and operating system. In Windows<sup>®</sup>, the file path will be similar to:

C:\Program Files\COMSOL\COMSOL62\Multiphysics\applications.

Now, import the ready-made geometry file as follows.

- I In the **Model Builder** window, under **Component 1**, right-click **Geometry 1**  and select **Import** .

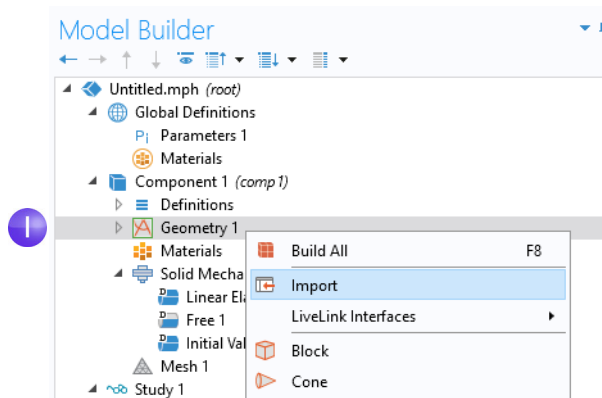

As an alternative, you can use the ribbon and click **Import**  from the **Geometry** tab.

- In the **Settings** window for **Import**, from the **Source** list, if not already selected, select **COMSOL Multiphysics file**.

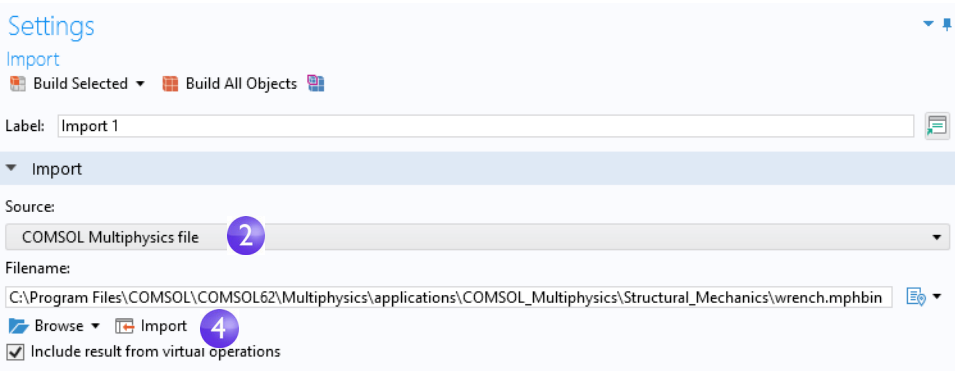

- Click **Browse** and locate the file `wrench.mphbin` in the application library folder of the COMSOL installation folder. Its default location in Windows<sup>®</sup> is





```
C:\Program Files\COMSOL\COMSOL62\Multiphysics\applications\  
COMSOL_Multiphysics\Structural_Mechanics\wrench.mphbin
```

Double-click to add or click **Open**.

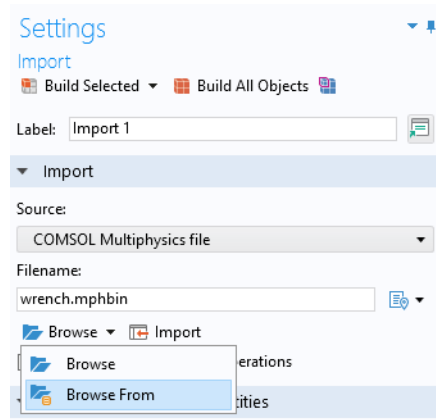
- Click **Import**. The geometry is now displayed in the **Graphics** window.

! In the **Import** section, there are two options for locating a file for import: **Browse** and **Browse From**. The **Browse** option lets you import a file from the file system using the **Open** dialog box. The **Browse From** option lets you browse from either the file system or a Model Manager database.



5 Click the wrench geometry in the **Graphics** window and then experiment with moving it around. As you point to or click the geometry, it changes color. Click the **Zoom In** , **Zoom Out** , **Go to Default 3D View** , **Zoom Extents** , and **Transparency**  buttons on the **Graphics** window toolbar to see what happens to the geometry:

- To rotate, click and drag anywhere in the **Graphics** window.
- To move, right-click and drag.
- To zoom in and out, click the mouse scroll wheel, continue holding it, and drag.
- To get back to the original position, click the **Go to Default 3D View**  button on the toolbar.

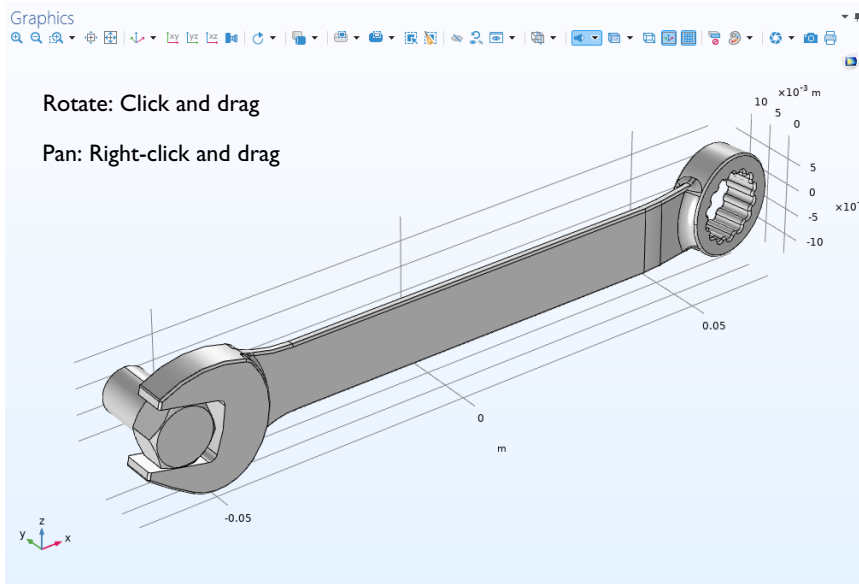

Also see “Appendix B — Keyboard and Mouse Shortcuts” on page 231 for additional information.



The imported model has two parts, or domains, corresponding to the bolt and the wrench. In this exercise, the focus will be on analyzing the stress in the wrench.

# Materials

The **Materials** node  stores the material properties for all physics and all domains in a **Component** node. Use the same generic steel material for both the bolt and tool. Here is how to choose it in the Model Builder.

**1** Open the **Add Materials** window.

You can open the **Add Materials** window in either of these two ways:

- Right-click **Component 1** > **Materials**  in the **Model Builder** window and select **Add Material from Library** .

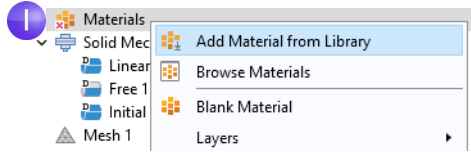

- From the ribbon, select the **Home** tab and then click **Add Material**.

**2** In the **Add Material** window, click to expand the **Built-In** folder. Scroll down to find **Structural steel**, right-click, and select **Add to Component 1**.

**3** Examine the **Material Contents** section in the **Settings** window for **Material** to see the properties that are available. Properties with check marks are used by the physics in the simulation.

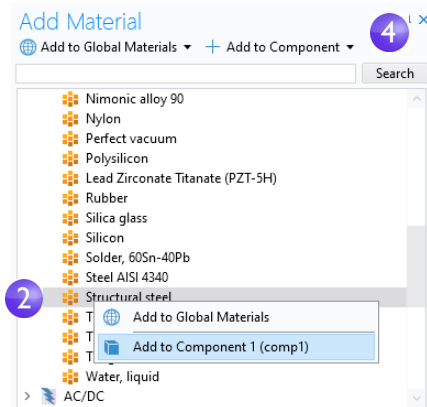

**4** Close the **Add Material** window.

**3**

Material Contents					
Property	Variable	Value	Unit	Property group	
<input checked="" type="checkbox"/> Density	rho	7850[kg/m^3]	kg/m^3	Basic	
<input checked="" type="checkbox"/> Young's modulus	E	E(T)	Pa	Young's modulus and Poisson's ratio	
<input checked="" type="checkbox"/> Poisson's ratio	nu	nu(T)	1	Young's modulus and Poisson's ratio	
Isotropic structural loss factor	eta_s	0.02	1	Basic	
Relative permeability	mur_iso ; m...	1	1	Basic	
Heat capacity at constant pressure	Cp	475[J/(kg*K)]	J/(kg-K)	Basic	
Thermal conductivity	k_iso ; kii =...	44.5[W/(m*K)]	W/(m-K)	Basic	
Electrical conductivity	sigma_iso ;...	4.032e6[S/m]	S/m	Basic	
Relative permittivity	epsilon_on_iso...	1	1	Basic	
Coefficient of thermal expansion	alpha_iso ;...	12.3e-6[1/K]	1/K	Basic	
Murnaghan third-order elastic moduli	l	-3.0e11[Pa]	N/m^2	Murnaghan	



Note that some properties are available as functions of temperature  $T$ . If you have no heat transfer physics defined in a model, then this temperature is taken from the **Default Model Inputs** under **Global Definitions**.

See the busbar tutorial sections “Materials” on page 89 and “Customizing Materials” on page 141 to learn more about working with materials.

# Global Definitions

You will now define a global parameter specifying the load applied to the wrench.

## Parameters

1 In the **Model Builder** window, under **Global Definitions** , choose **Parameters**

1 P1 .

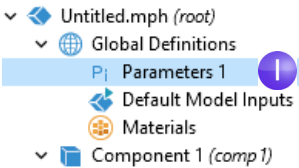

2 Go to the **Settings** window for **Parameters 1**. In the **Parameters** table, enter these settings:

- In the **Name** column or field, enter F.
- In the **Expression** column or field, enter 150[N]. The square-bracket notation is used to associate a physical unit to a numerical value; in this case, the unit of force in Newtons. The **Value** column is automatically updated based on the expression entered once you leave the field or press Return.
- In the **Description** column or field, enter Applied force.

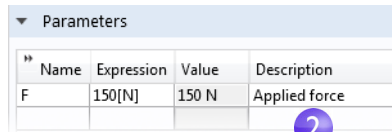

Name	Expression	Value	Description
F	150[N]	150 N	Applied force

 If you have a **Parameters** table with more than one entry, you can sort the table with respect to a particular column by clicking on the corresponding header.

The sections “Global Definitions” on page 81 and “Parameters, Functions, Variables, and Couplings” on page 136 show you more about working with parameters.

So far, you have added the physics and study, imported a geometry, added the material, and defined one parameter. The **Model Builder** node sequence should now match the figure to the right. The default feature nodes under **Solid Mechanics** are indicated by a **D** in the upper-left corner of the node icon .

The default nodes for **Solid Mechanics** are: **Linear Elastic Material**, **Free**, and **Initial Values**.

The node **Linear Elastic Material** is the default material model for the **Solid Mechanics** interface. The node **Free** is a boundary condition that allows all boundaries to move freely without a constraint or load. The node **Initial Values** is used for specifying initial displacement and velocity values for a nonlinear or transient analysis (not applicable in this case).

The default physics nodes cannot be removed. Instead, you specify physics settings that deviate from that of the default nodes by adding additional nodes. These additional nodes can override or contribute to the settings of the default nodes as well as other nodes. For more information, see “Override and Contribution: Exclusive and Contributing Nodes” on page 153.

At any time, you can save your model and then open it later in exactly the state in which it was saved.

- 3 From the **File** menu, select **Save As**. Browse to a folder where you have write permissions and save the file as `wrench.mph`.

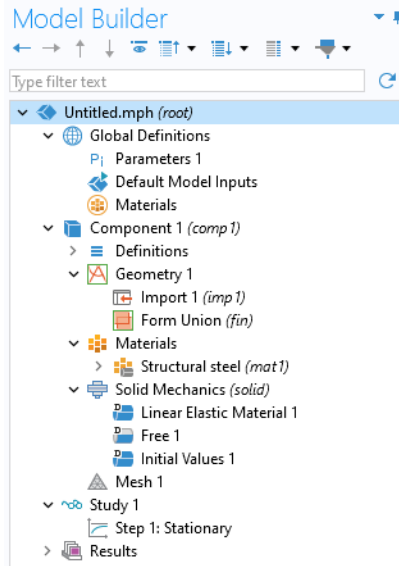

# Physics and Boundary Conditions

With the geometry and materials defined, you are now ready to set the boundary conditions.

1 In the **Model Builder** window, right-click **Solid Mechanics (solid)** and select **Fixed Constraint**.

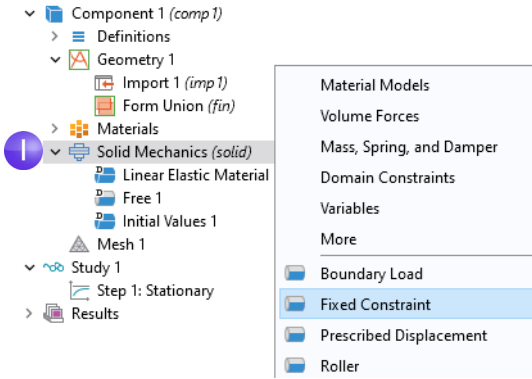

This boundary condition constrains the displacement of each point on a boundary surface to be zero in all directions.

You can also use the ribbon and, from the **Physics** tab, select **Boundaries > Fixed Constraint**.

2 In the **Graphics** window, rotate the geometry by clicking anywhere in the window and then dragging the wrench into the position shown. Click on the exposed front surface of the partially modeled bolt. The boundary turns blue, indicating that it has been selected. The **Boundary number** in the **Selection** list should be **35**.

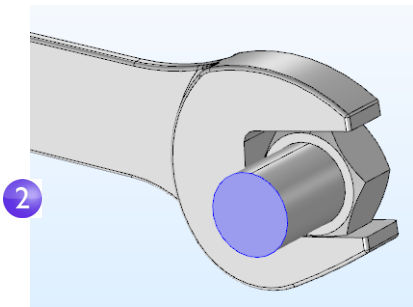

3 Click the **Go to Default View** button on the **Graphics** toolbar to restore the geometry to the default view.

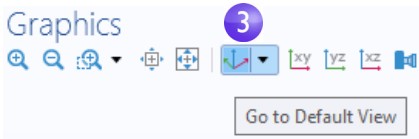



- In the **Model Builder** window, right-click **Solid Mechanics (solid)** and select **Boundary Load**. A **Boundary Load** node is added to the **Model Builder** sequence.

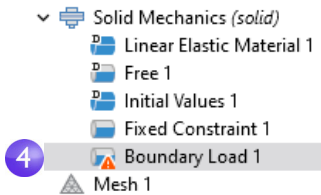

The “warning” attribute displayed on the **Boundary Load** node indicates that its boundary selection is empty. The next step will be to select a boundary.

- In the **Graphics** window, click the **Zoom Box** button on the toolbar and drag the mouse to select the square region shown in the figure to the right. Release the mouse button to zoom in on the selected region.

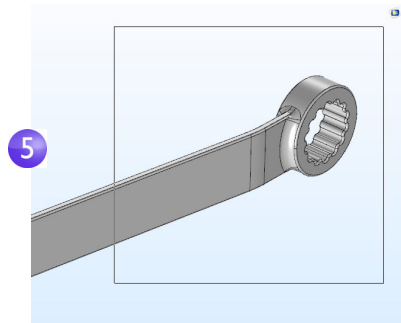

- Select the top socket face (boundary III) by clicking the boundary to highlight it in blue and add it to the **Selection** list.

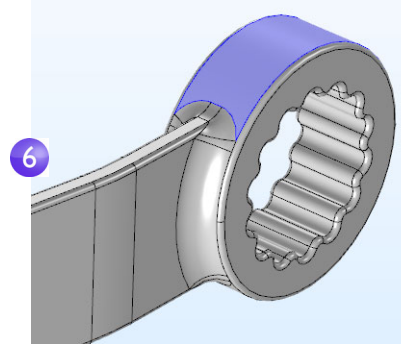

- In the **Settings** window for **Boundary Load**, under **Force**, select **Total force** as the **Load type** and enter  $-F$  in the text field for the  $z$  component. The negative sign indicates the negative  $z$  direction (downward). With these settings, the load of 150 N will be distributed uniformly across the selected surface.

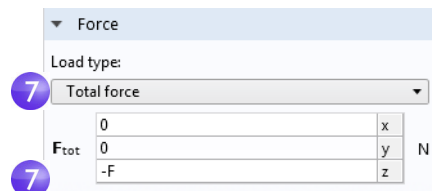

Note that to simplify the modeling process, the mechanical contact between the bolt and the wrench is approximated with a material interface boundary condition. Such an internal boundary condition is automatically defined and guarantees continuity in normal stress and displacement across a material interface. A more detailed analysis including mechanical contact can be done with the Structural Mechanics Module.

### ADDING A PARAMETER DIRECTLY FROM A TEXT FIELD

As an alternative to the method shown above, you can add or edit a parameter directly from a text field. For example, in the case of the wrench model, first type the value of the **Total force** in the text field for the z component. Then, right-click the text field and select **Create Parameter** from the drop-down menu to open a **Create Parameter** dialog box, as shown in the second figure below.

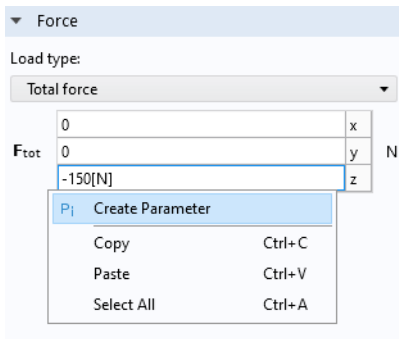

In this dialog box, you can enter a parameter **Name** and **Description**.

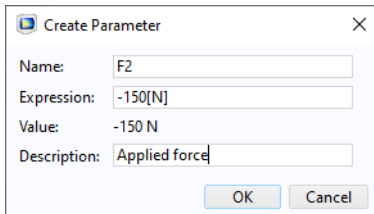

The parameter is now added to the list of **Parameters**, as shown below.

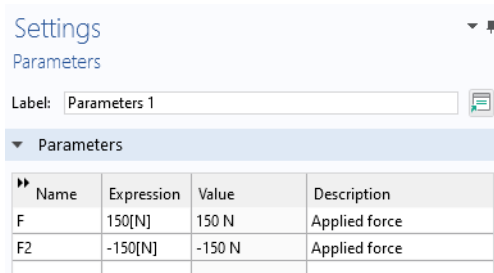

To edit a parameter, select the parameter in an edit field, right-click, and choose **Edit Parameter**.

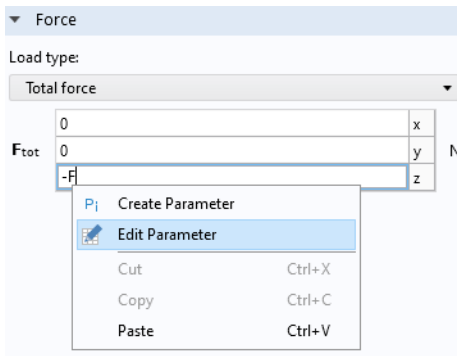

Note that when you hover over edit fields and table cells, a tooltip shows the value of the parameter or expression. This only works when the value is a constant.

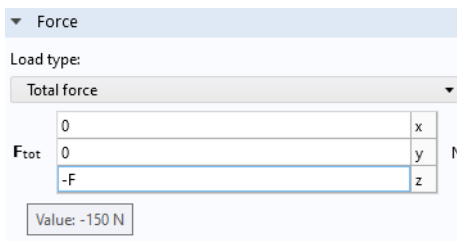

## SELECTING BOUNDARIES AND OTHER GEOMETRIC ENTITIES

When a boundary is unselected, its color is typically gray. The exception is when you use the material **Appearance** setting available in **Materials**; see page 93. To select a boundary, first hover over it. This highlights the boundary in red, assuming the boundary was previously unselected. Now, click to select the

boundary by using the left mouse button. The boundary now turns blue. Its boundary number will appear in the **Selection** list in the **Settings** window of the corresponding boundary condition. Once a boundary is selected and you hover over it again, the boundary turns green. If you click a boundary highlighted in green, the boundary is deselected and now turns gray again. The same technique for selecting and deselecting is applicable to geometry objects, domains, boundaries, edges, and points.

The figure below shows the different selection states for a boundary.

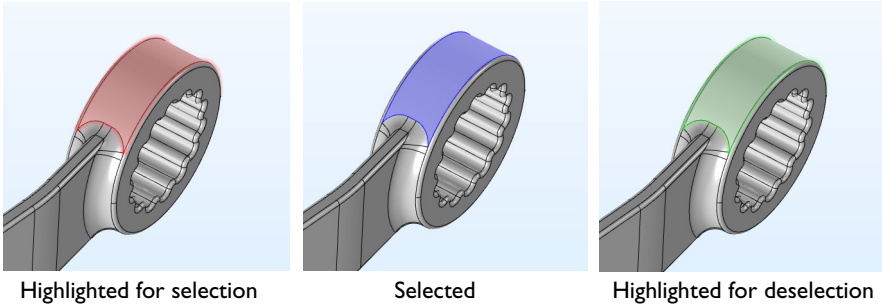

To select internal surfaces that are hidden behind the one closest to you, use one of the following methods to cycle through the boundaries at the mouse pointer: roll the mouse scroll wheel, use the keyboard + and - buttons, use the keyboard arrow-up and arrow-down buttons, or use two-finger drag on a touchpad.

When hovering over a boundary, information about the boundary number and surface normal direction is displayed in the upper-left corner of the **Graphics** window, as shown in the figure below.

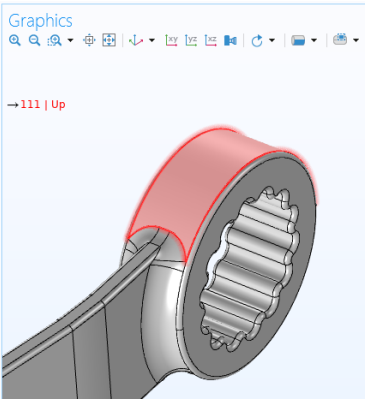

Similarly, when selecting domains, edges, and vertices the corresponding geometric entity number is displayed.

For each boundary surface, the normal vector has a “positive” and “negative” direction, referred to as the up and down direction, respectively. When hovering over a surface, the information display shows which normal direction is currently pointing toward you. This information can be useful, for example, when defining more advanced boundary conditions, especially on material interfaces.

## SELECTING USING THE GRAPHICS WINDOW CONTEXT MENUS

As an alternative selection method, you can right-click in the **Graphics** window and choose one of the options for domain, boundary, edge, or point selection.

For example, to assign a **Boundary Load** boundary condition, first right-click and select **New Boundary Selection**, as shown in the figure below.

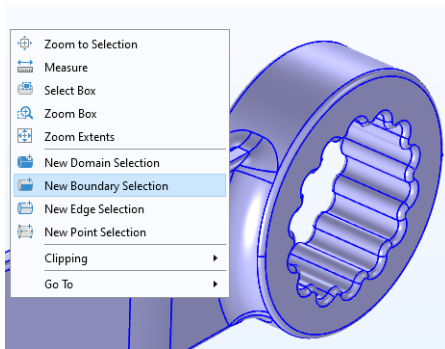

Click to select the boundaries to which you would like to apply the boundary condition. (In this case, the top socket face; boundary III.) Then, right-click again and select **Boundary Load**, as shown in the figure below.

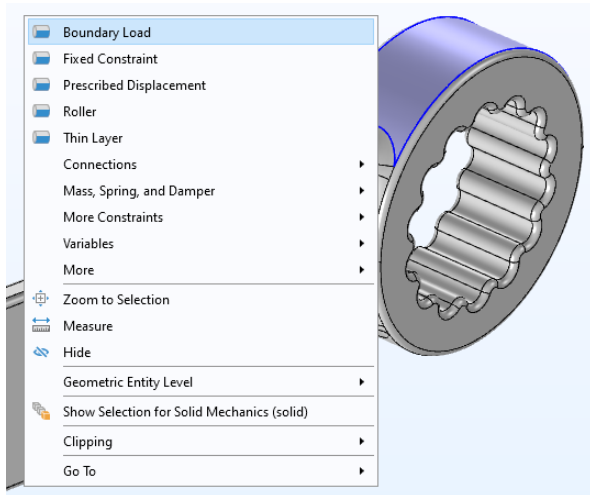

You can also use this method to add additional boundaries to the selections of an already created boundary condition. In the example above, you could, for example, while having the **Fixed Constraint** node selected, select the menu option **Add to Boundary Selection for Fixed Constraint I** (although it wouldn't be applicable in this example).

## SELECTING USING CLIP PLANES

For selecting geometric entities inside complicated CAD models, you can use clip planes, clip boxes, clip spheres, or clip cylinders. You select these from the graphics toolbar by clicking the **Clipping** toolbar button.

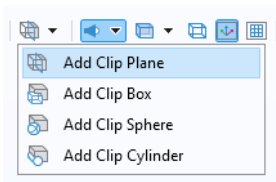

By selecting a **Clip Plane**, for example, you can quickly hide all parts of a model that is on one side of the plane. The figure below shows a clip plane used to select one of the interior boundaries of the wrench model.

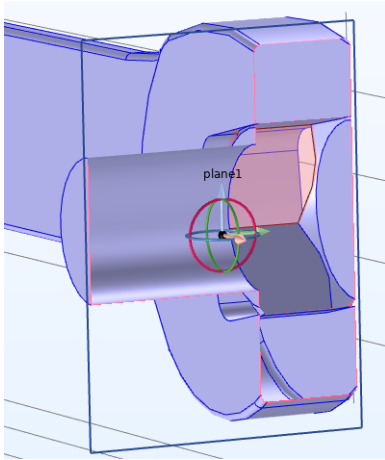

## Mesh

---

The mesh settings determine the resolution of the finite element mesh used to discretize the model. The finite element method divides the model into small elements of geometrically simple shapes, in this case tetrahedra. In each tetrahedron, a set of polynomial functions is used to approximate the structural displacement field — how much the object deforms in each of the three coordinate directions. The strains are computed by differentiating the displacement field. Then, the stresses are computed from the strains using the material properties.

In this example, because the geometry contains small edges and faces, you will define a slightly finer mesh than the default setting suggests. This will better resolve the variations of the stress field and give a more accurate result. Refining the mesh size to improve computational accuracy always involves some sacrifice in speed and typically requires increased memory usage.

- 1 In the **Model Builder**, under **Component 1**, click **Mesh 1** . In the **Settings** window for **Mesh**, under **Mesh Settings**, select **Finer** from the **Element size** list.

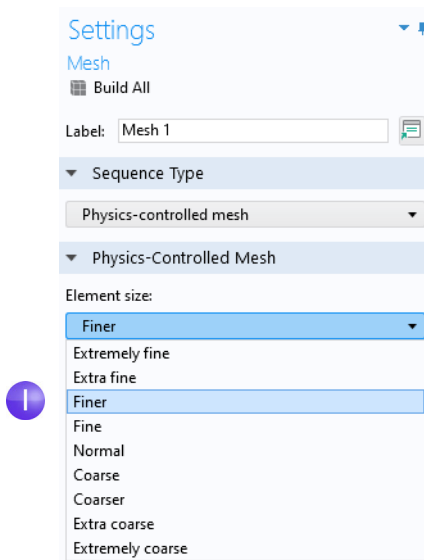

- 2 Click the **Build All** button  in the **Settings** window or on the **Mesh** toolbar.

With the resulting mesh, the model will require about 5GB to solve. If you have a computer with less than 5GB of RAM you can select **Fine** from the **Element size** list (instead of **Finer**.)



- 3 After a few seconds, the mesh is displayed in the **Graphics** window. Rotate the wrench to take a look at the element size distribution (this may vary a bit depending on the version you are running).

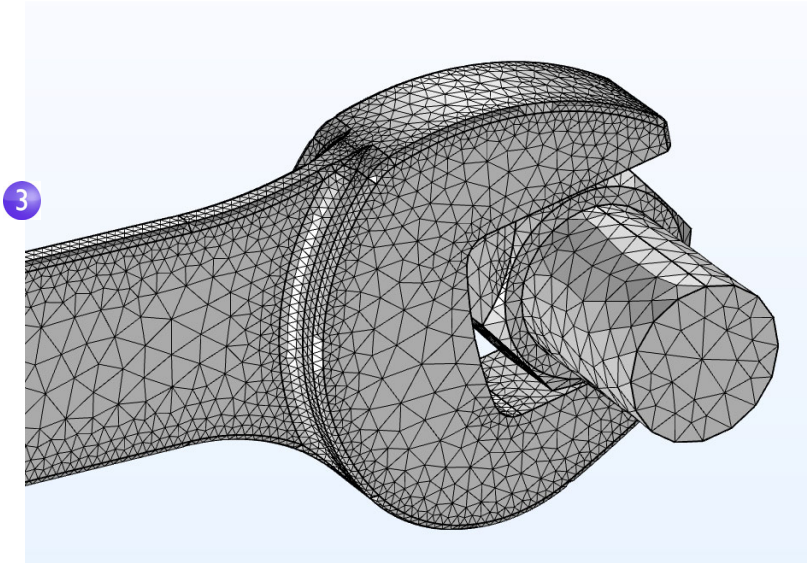

# Study

In the beginning of setting up the model, you selected a **Stationary** study, which implies that a stationary solver will be used. For this to be applicable, the assumption is that the load, deformation, and stress do not vary in time. To start the solver:

- Right-click **Study 1** and select **Compute** = (or press F8).

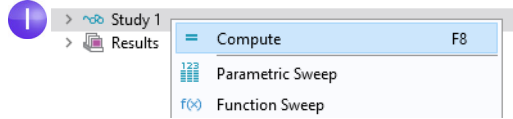

After a few seconds of computation time, the default plot is displayed in the **Graphics** window. During computation, a **Progress** window shows progress information from the solvers. After the computation you can find other useful information about the computation in the **Messages** and **Log** windows; Click the **Messages** and **Log** tabs under the **Graphics** window to see the kind of information available to you. The **Messages** window can also be opened from the **Windows** drop-down list in the **Home** tab of the ribbon.

```
Messages | Progress | Log
-----
<---- Stationary Solver 1 in Study 1/Solution 1 (sol1) -----
Started at Sep 20, 2023, 4:11:58 PM.
Linear solver
Number of degrees of freedom solved for: 410145 (plus 1 internal DOFs).
Symmetric matrices found.
Scales for dependent variables:
Displacement field (comp1.u): 1
Orthonormal null-space function used.
Iter      SolEst      Damping      Stepsize #Res #Jac #Sol      LinErr      LinRes
  1         0.88      1.0000000    0.88      1      1      1      2.6e-09     4.1e-09
Solution time: 11 s.
Physical memory: 5.45 GB
Virtual memory: 6.33 GB
Ended at Sep 20, 2023, 4:12:09 PM.
----- Stationary Solver 1 in Study 1/Solution 1 (sol1) ----->
```

## Results

---

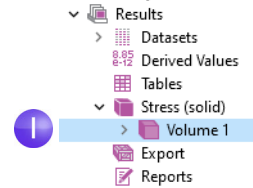

The von Mises stress is displayed in the **Graphics** window in a default **Volume** plot with the displacement visualized using a **Deformation** subnode. Change the default unit (N/m<sup>2</sup>) to the more suitable MPa as shown in the following steps.

- 1 In the **Model Builder**, expand the **Results > Stress (solid)** node, then click **Volume 1**.

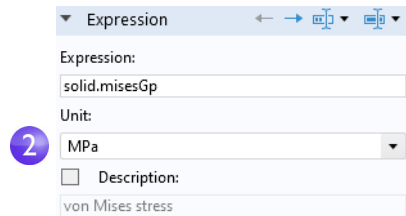

- 2 In the **Settings** window under **Expression**, from the **Unit** list, select **MPa** (or type MPa in the field).



- 3 Click the **Plot** button  on the toolbar of the **Settings** window for the **Volume** plot and then click the **Go to Default 3D View** button  on the **Graphics window** toolbar.

The von Mises stress distribution is shown in the bolt and wrench under an applied vertical load.

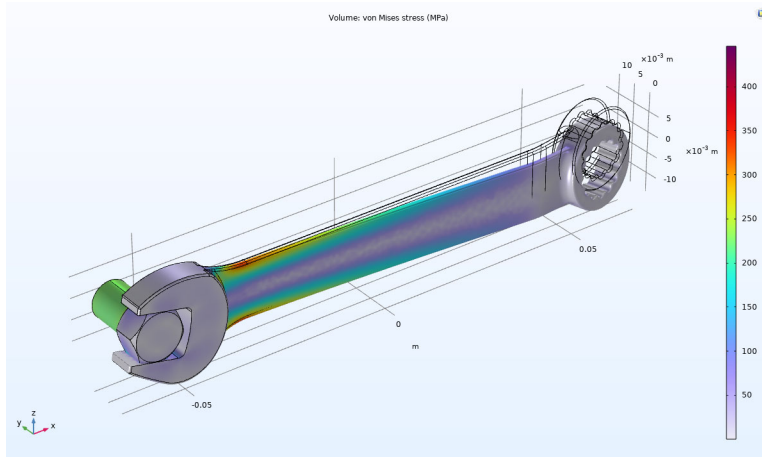

You can add additional predefined plots by selecting from the list defined by **Add Predefined Plot** under **Results** or by clicking the corresponding button from the ribbon **Home** tab.

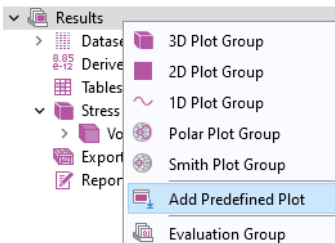

- 4 You can, for example, visualize the applied load distribution. Right-click **Results** and select **Add Predefined Plot**. In the **Add Predefined Plot** window, select **Solid Mechanics > Applied Loads > Boundary Loads** and click **Add Plot**.

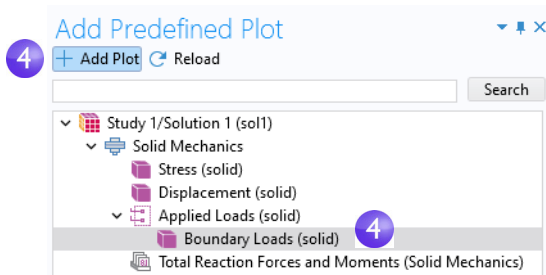

The resulting plot shows the boundary load using arrows.

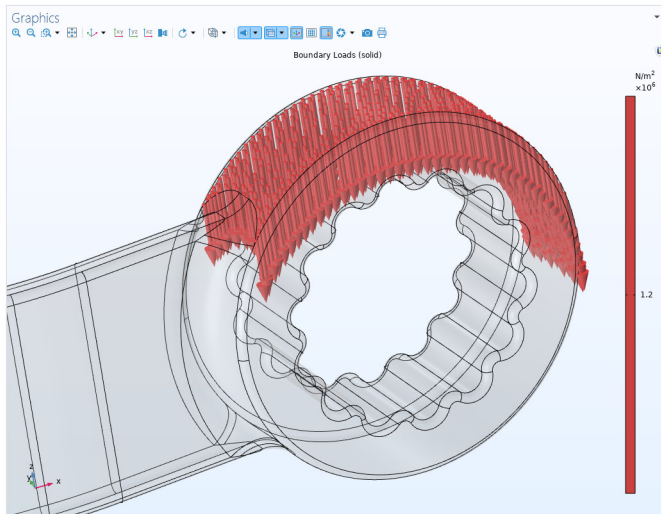

For our purposes we are not interested in the stress in the bolt. We can selectively visualize the stress in just the wrench by adding a **Selection** node.

1 Right-click the **Stress > Volume** node and select **Selection** .

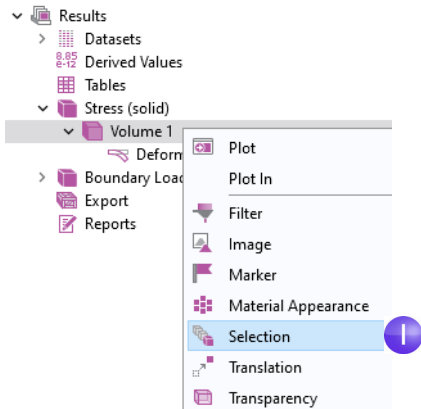

2 In the **Graphics** window, click the wrench, domain 1.

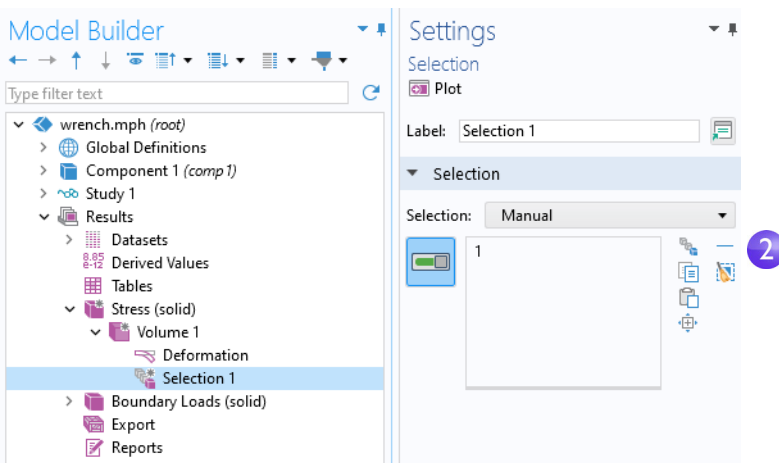

3 Click **Plot** to see the visualization.

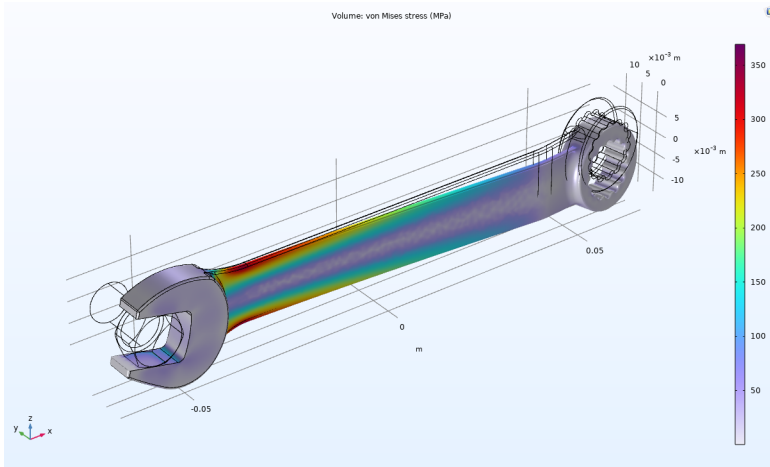

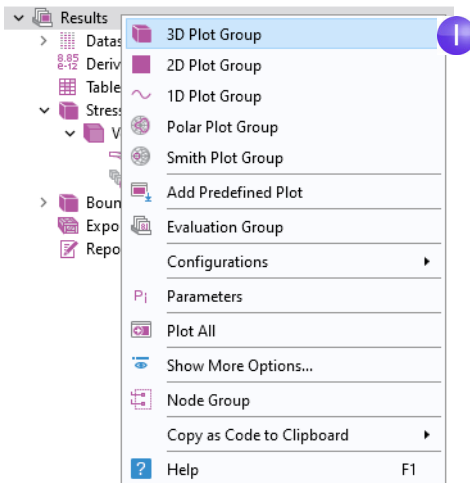

For a typical steel used for tools like a wrench, the yield stress is about 600 MPa, which means that we are getting somewhat close to plastic deformation for our 150 N load (which corresponds to about 34 pounds force). You may also be interested in a safety margin of, say, a factor of three. To quickly assess which parts of the wrench are at risk of plastic deformation, you can plot an inequality expression such as `solid.misesGp>200[MPa]`. (The suffix `Gp` indicates that the stress variables are obtained from the so called finite element Gauss points.)

1 Right-click the **Results** node  and add a **3D Plot Group** .

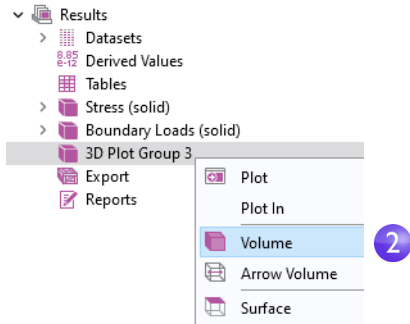

2 Right-click the **3D Plot Group 3** node  and select **Volume** .



3 In the **Settings** window for **Volume**, click the **Replace Expression** button  and select **Model > Component 1 > Solid Mechanics > Stress > solid.mises-von Mises stress - N/m<sup>2</sup>** by double-clicking.

When you know the variable name beforehand, you can also directly enter `solid.misesGp` in the **Expression** field.

Now edit this expression to:

```
solid.misesGp>200[MPa].
```

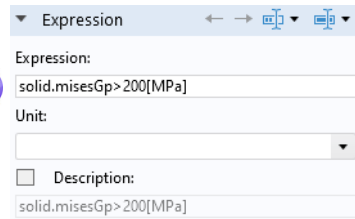

This is a Boolean expression that evaluates to either 1 for true or 0 for false. In areas where the expression evaluates to 1, the safety margin is exceeded.

4 Change the **Color table** to **RainbowLight** and click the **Plot** button .

5 In the **Model Builder** window, click **3D Plot Group 3**. Press F2 and, in the **Rename 3D Plot Group** dialog box, enter `Safety Margin`. Click **OK**. Alternatively, edit the label at the top of the **Settings** window.

 Note that it is sometimes quicker to right-click a **Plot Group**, select **Duplicate** from the menu, and then make the necessary changes to the plot settings.

The resulting plot shows that the stress in the bolt is high, but the focus of this exercise is on the wrench. If you wish to comfortably certify the wrench



for a 150 N load with a factor-of-three safety margin, you would need to change the handle design somewhat, such as by making it wider.

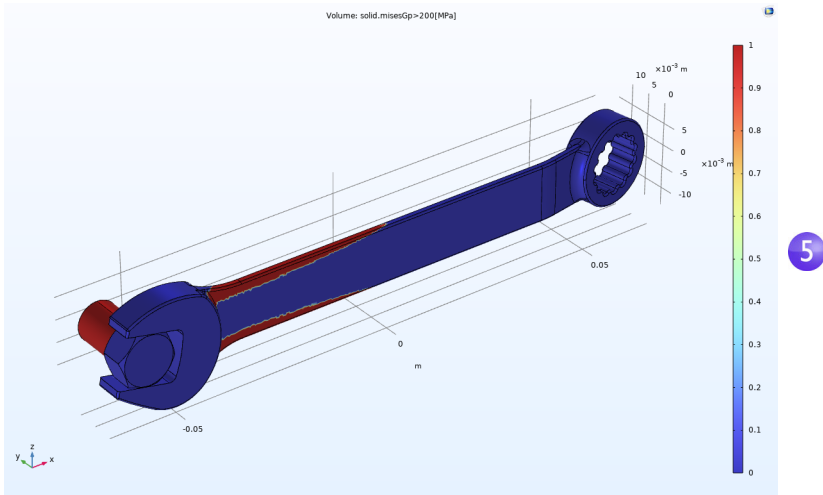

You may have noticed that the manufacturer, for various reasons, has chosen an asymmetric design for the wrench. Because of that, the stress field may be different if the wrench is flipped around. Try now, on your own, to apply the same force in the other direction and visualize the maximum von Mises stress to see if there is any difference.

## Convergence Analysis

---

The results from a simulation software such as COMSOL Multiphysics can shorten design times dramatically by, for example, reducing the number of experiments or product tests. However, simulation software is not a substitute for real-world testing. This is especially important if there are risks for physical or environmental damage. One way to reduce (but not eliminate) the risk of drawing the wrong conclusions from simulation results is to perform a convergence analysis.

To check the accuracy of the computed maximum von Mises stress in the wrench, you can now continue with a mesh convergence analysis. Do that by using a finer mesh and therefore a higher number of degrees of freedom (DOFs).



This section illustrates some more in-depth functionality and the steps below could be skipped at a first reading. Note that since the mechanical contact between the bolt and the wrench is approximated with a material interface boundary condition, there will be stress singularities in this area. Due to this, we will neglect the stresses there and focus on the handle. A more detailed analysis including mechanical contact can be done with the Structural Mechanics Module.

### EVALUATING THE MAXIMUM VON MISES STRESS

- 1 To study the maximum von Mises stress in the wrench, in the **Results** section of the model tree, right-click the **Derived Values**  node and select **Maximum > Volume Maximum** MAX.
- 2 In the **Settings** window for **Volume Maximum**, under **Selection**, choose **Manual** and select the wrench, domain 1, by clicking on the wrench in the **Graphics** window. We will only consider values in the wrench domain and neglect those in the bolt. In addition, since we are only interested in the stress values in the handle, which we can achieve by multiplying the stress variable with the expression  $(x > -0.045)$ .
- 3 In the first row of the **Expressions** table, in the **Expression** column, type `solid.mises*(x>-0.045)`.

4 In the **Expressions table**, type MPa as the **Unit**.

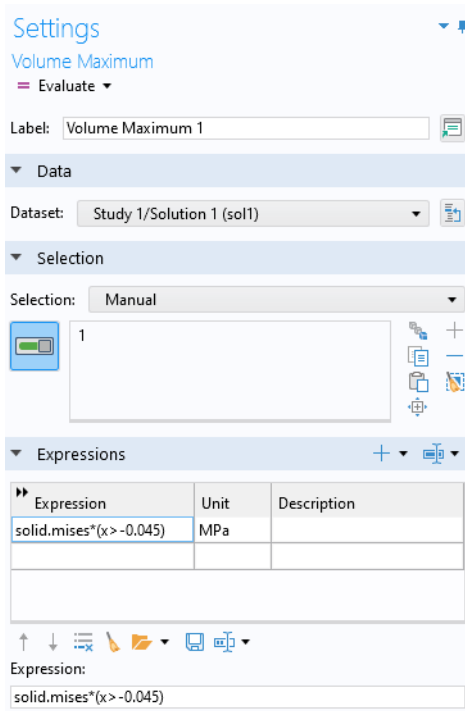

In addition, to get optimal accuracy, in the same settings window, in the **Configuration** section, change the **Point type** to **Gauss points**.

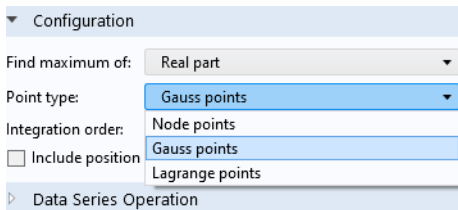

5 In the **Settings** window for **Volume Maximum**, click **Evaluate** to evaluate the maximum stress. The result will be displayed in a **Table** window and will be approximately 371 MPa. The value may vary slightly depending on the software version and hardware platform.

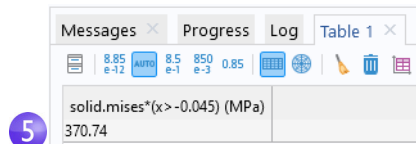

- 6 To see where the maximum value is attained, you can, for example, use a **Max/Min Volume** plot. Right-click the **Results** node and add a **3D Plot Group**. Next, right-click the **3D Plot Group 4** node and select **More Volume Plots > Max/Min Volume**. Change the name of **3D Plot Group 4** to **Max/Min Stress**.
- 7 To plot values in the wrench and not in the bolt, right-click the **Max/Min Volume** node, select **Selection**, and then select the wrench, domain number 1.
- 8 In the **Settings** window for **Max/Min Volume**, in the **Expression** text field, type `solid.misesGp*(x>-0.045)`. Alternatively, you can use a **Filter** node: Right-click the **Max/Min Volume** plot, select **Filter**, and change the Logical expression for inclusion to `x>-0.045`.
- 9 In the **Settings** window under **Expression**, from the **Unit** list, select **MPa** (or enter MPa in the field).
- 10 Click the **Plot** button. This type of plot simultaneously shows the location of the maximum and minimum values and also their coordinate location in the table below (the exact values may differ depending on the version you are running).

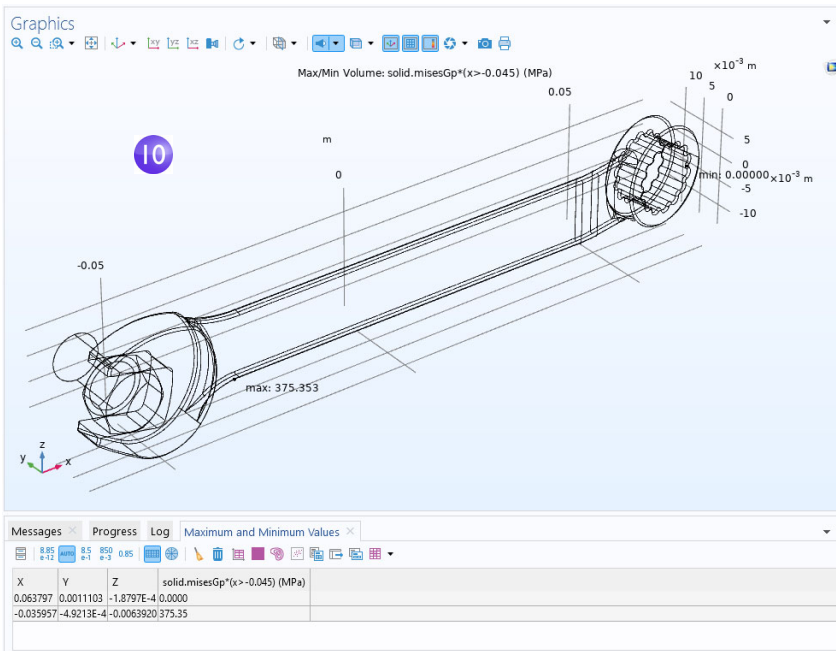



An alternative way of plotting the maximum and minimum stress is to right-click the **Stress > Volume** plot and select **Marker**.

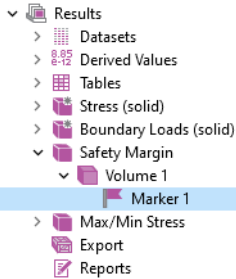

Note that the maximum and minimum values using this approach can differ somewhat since the evaluation method is slightly different.

## PARAMETERIZING THE MESH

We will now define a parametric sweep for successively refining the mesh size while solving and then finally plot the maximum von Mises stress versus mesh size. First, we define the parameters that will be used for controlling the mesh density.

- 1 In the **Model Builder** window, click **Parameters 1**  $P_1$  under **Global Definitions**  $\oplus$ .
- 2 Go to the **Settings** window for **Parameters**. In the **Parameters** table (or under the table in the fields), enter these settings:
  - In the **Name** column or field, enter **hd**. This parameter will be used in the parametric sweep to control the element size.
  - In the **Expression** column or field, enter **2**.
  - In the **Description** column or field, enter **Element size divider**.

- 3 Now, enter another parameter with **Name** **h0**, **Expression** **0.01**, and **Description** **Starting element size**. This parameter will be used to define the element size at the start of the parametric sweep.

Name	Expression	Value	Description
F	150[N]	150 N	Applied force
hd	2	2	Element size divider
h0	0.01	0.01	Starting element size

- 4 In the **Model Builder** window, under **Component 1**, click **Mesh 1**  $\triangle$ . In the **Settings** window for **Mesh**, select **User-controlled mesh** from the **Sequence type** list.
- 5 Under **Mesh 1**, click the **Size** node  $\triangle$ .

- 6 In the **Settings** window for **Size**, under **Element Size**, click the **Custom** button.
- Under **Element Size Parameters**, enter:
- $h_0/h_d$  in the **Maximum element size** field.
  - $h_0/(4 \cdot h_d)$  in the **Minimum element size** field.
  - 1.3 in the **Maximum element growth rate** field.
  - 0.1 in the **Curvature factor** field.
  - 0.2 in the **Resolution of narrow regions** field.
- See page 103 for more information on the element size parameters.

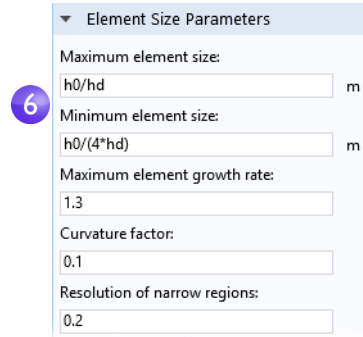

## PARAMETRIC SWEEP AND SOLVER SETTINGS

As a next step, add a parametric sweep for the parameter  $h_d$ .

- 1 In the **Model Builder** window, right-click **Study 1** and select **Parametric Sweep**. A **Parametric Sweep** node is added to the **Model Builder** sequence.

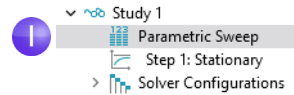

- 2 In the **Settings** window for **Parametric Sweep**, under the table in the **Study Settings** section, click the **Add** button  $+$ . From the **Parameter name** list in the table, select  $h_d$ .

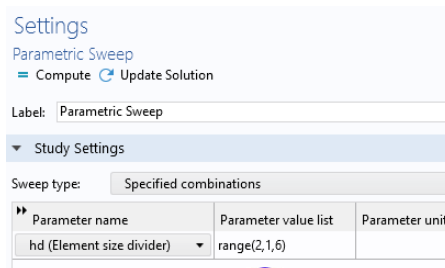

- 3 Enter a range of **Parameter values** to sweep for. Click the **Range** button and enter the values in the **Range** dialog box. In the **Start** field, enter 2. In the **Step** field, enter 1, and in the **Stop** field, enter 6. Click **Replace**. The **Parameter value list** will now display range(2, 1, 6).



The settings above make sure that as the sweep progresses, the value of the parameter  $h_d$  increases and the maximum and minimum element sizes decrease.

See page 169 for more information on defining parametric sweeps.

For the highest value of  $h_d$ , the number of DOFs will exceed one million. Therefore, we will switch to a more memory-efficient iterative solver.

4 Under **Study 1 > Solver Configurations > Solution 1**, expand the **Stationary Solver 1** node , and right-click **Suggested Iterative Solver**  and select **Enable**. Selecting an iterative solver option typically reduces memory usage but may require physics-specific tailoring of the solver settings for efficient computations.

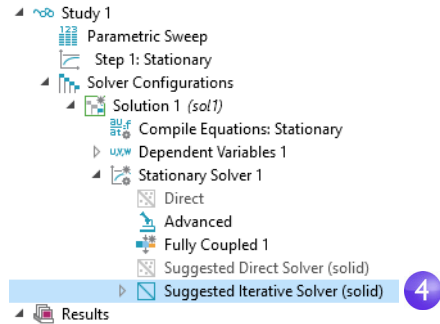

5 Under **General** in the **Settings** window for **Suggested Iterative Solver**, change the **Preconditioning** to **Right**. (This is a low-level solver option, which in this case will suppress a warning message that would otherwise appear. However, this setting does not affect the resulting solution. Preconditioning is a mathematical transformation used to prepare the finite element equation system for using the iterative solver.)

6 Click the **Study 1** node and select **Compute** = , either in the **Settings** window or by right-clicking the node. You can also click **Compute** on the ribbon **Home** or **Study** tab. The computation time will be a few minutes (depending on the computer hardware) and memory usage will be about 4GB.

## RESULTS ANALYSIS

Note that after running the parametric sweep, a new default plot node is created corresponding to the new **Dataset Study 1/Parametric Solutions 1**.

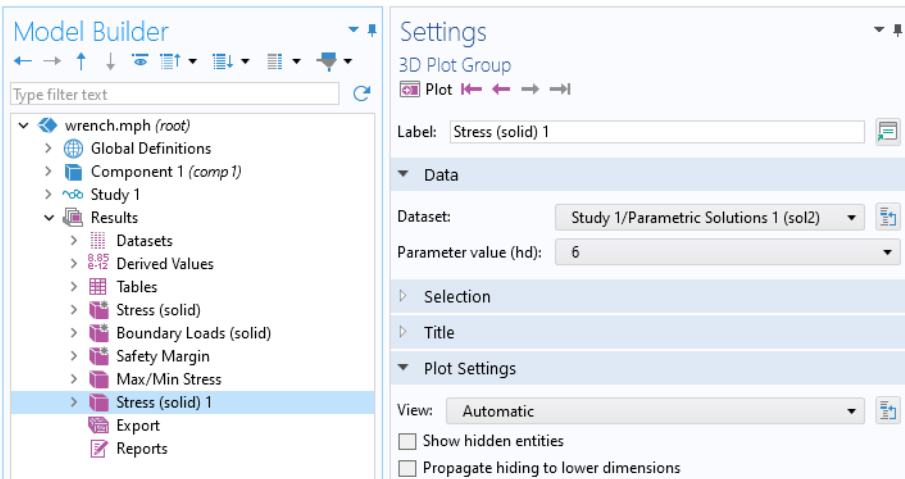

As a final step, analyze the results from the parametric sweep by displaying the maximum von Mises stress in a table.

- 1 In the **Model Builder** window, under **Results > Derived Values**, select the **Volume Maximum I** node MAX.

The solutions from the parametric sweep are stored in the **Dataset** named **Study I/Parametric Solutions I**. Now, change the **Volume Maximum** settings accordingly:

- 2 In the **Settings** window for **Volume Maximum**, change the **Dataset** to **Study I/Parametric Solutions I**.
- 3 Click the arrow next to the **Evaluate** button at the top of the **Settings** window for **Volume Maximum** and select to evaluate in a **New Table**. This evaluation may take 10 seconds or so, depending on the computer.
- 4 To plot the results in the **Table**, click the **Table Graph**  button at the top of the **Table** window (the first few values will vary due to slight mesh variations between versions for coarser meshes before a more mesh-converged value has been reached).

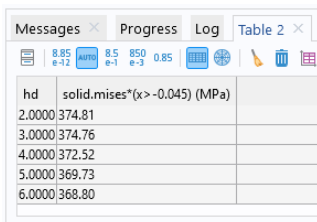

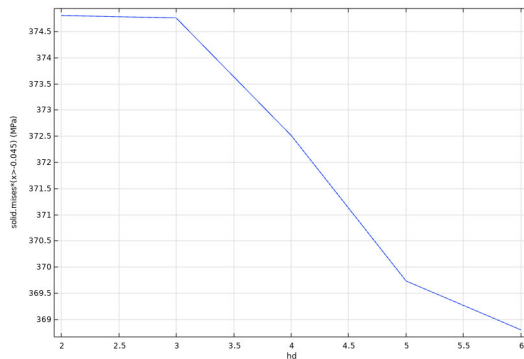

hd	solid.mises*(x>-0.045) (MPa)
2.0000	374.81
3.0000	374.76
4.0000	372.52
5.0000	369.73
6.0000	368.80

4



It is more interesting to plot the maximum value vs. the number of DOFs. This is possible by using the built-in variable `numberofDOFs`.

- 5 Right-click the **Derived Values** node  and select **Global Evaluation** .
- 6 In the **Settings** window for **Global Evaluation**, change the **Dataset** to **Study I/Parametric Solutions I**.
- 7 In the **Expressions** field, enter `numberofDOFs`.



You can type the first few characters of the variable name and then use the keyboard shortcut **Ctrl+Space** to get a variable suggestion from the list of available variables.



- 8 In the **Settings** window for **Global Evaluation**, click the arrow next to the **Evaluate** button and select the option to evaluate in **Table 2**, or **Table 1**, depending on which previous steps you chose to follow. This displays the DOF values for each parameter next to the previously evaluated data.

This mesh-convergence analysis shows that the computed value of the maximum von Mises stress in the wrench handle will decrease from the high original value, for a mesh with about 115,000 DOFs, to about 369 MPa for a mesh with about 1,000,000 DOFs. If we further refine the mesh we will find that the results will stay approximately around the value 369 MPa. Note that in this parametric sweep the coarsest mesh is coarser than the preset **Finer** mesh used in the wrench before the convergence study.

The figure below shows the associated **Table Graph** and **Table Graph Settings** window.

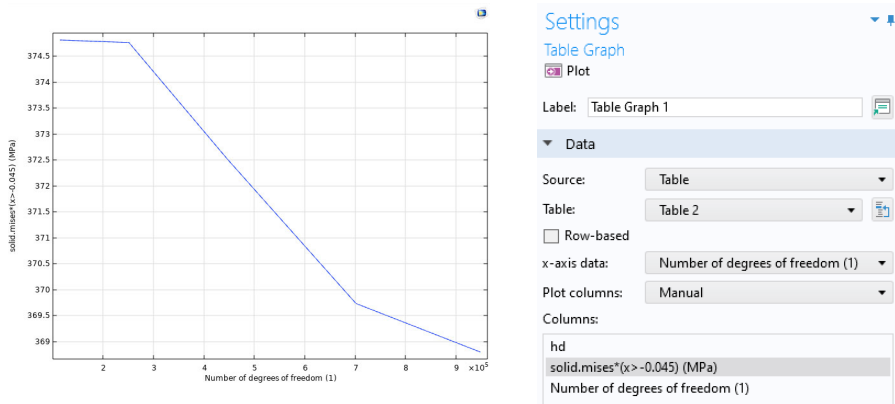

Note that depending on the version of COMSOL Multiphysics that you are running, the above values may vary slightly due to variations in the number of elements generated by the meshing algorithm.

As an alternative to **Derived Values**, you can use **Evaluation Groups**. An **Evaluation Group** shares some of the properties of **Plot Groups** as well as **Derived Values**. An **Evaluation Group** comes with an integrated table whereas **Derived Values** outputs to a table of your choice. In addition, **Evaluation Groups** allows you to automatically

reevaluate after solving. To enable this, select the corresponding check box in the **Settings** window of the **Results** node as shown in the figure below.

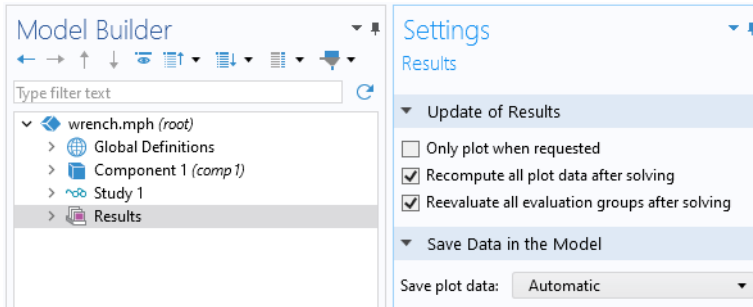

In this **Settings** window you can also request to regenerate all plots after solving. You add an **Evaluation Group** in the same way as a **Plot Group**: by right-clicking the **Results** node. The figure below shows an **Evaluation Group** that performs the same task as the **Derived Values** described earlier.

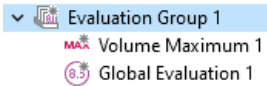

As done previously for **Derived Values**, to get optimal accuracy, in the **Volume Maximum** settings window, in the **Configuration** section, change the **Point type** to **Gauss points**.

The figure below shows the corresponding **Evaluation Group** table.

hd	solid.mises*(x>-0.045) (MPa)	Number of degrees of freedom (1)
2.0000	374.81	1.1444E5
3.0000	374.76	2.5128E5
4.0000	372.52	4.4646E5
5.0000	369.73	7.0155E5
6.0000	368.80	9.4819E5

This concludes the wrench tutorial.

## Example 2: The Busbar — A Multiphysics Model

---

### *Electrical Heating in a Busbar*

This tutorial demonstrates the concept of multiphysics modeling in COMSOL Multiphysics using the Model Builder. You will learn how to use one of the many preconfigured multiphysics combinations as well as subsequently add the effects of physics phenomena not initially included in the analysis. At the end, you will have built a truly multiphysics model.

The model that you are about to create analyzes a busbar designed to conduct a high amount of direct current in an industrial setting (see picture below). The current conducted in the busbar, from bolt 1 to bolts 2a and 2b, produces heat due to the resistive losses, a phenomenon referred to as Joule heating. The busbar is made of copper, while the bolts are made of a titanium alloy. Busbar bolts are usually made of steel, but in this example, we will assume a highly corrosive environment. Therefore, a titanium alloy was chosen.

Under normal operational conditions, the currents are predominantly conducted through the copper. This example, however, illustrates the effects of an unwanted electrical loading of the busbar through the bolts. The fact that there are different materials is important because titanium has a lower electrical conductivity than copper and will be subjected to a higher current density.

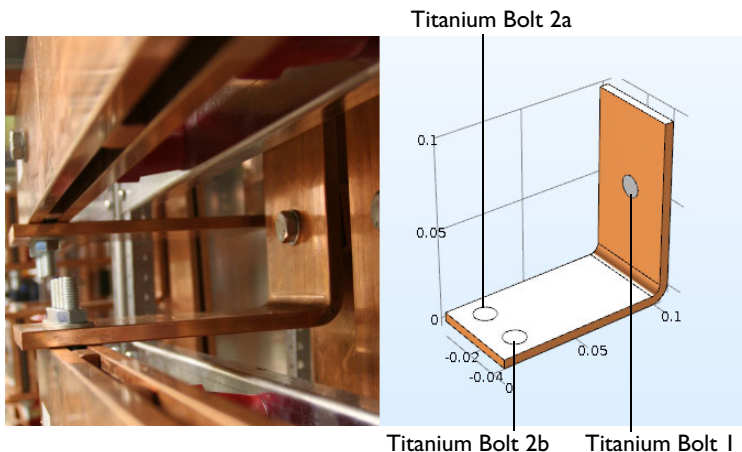

The goal of your simulation is to precisely calculate how much the busbar heats up. Once you have captured the basic multiphysics phenomena, you will have the chance to investigate thermal expansion that generates structural stresses and strains in the busbar and the effects of cooling by an air stream.

The Joule heating effect is described by conservation laws for electric current and energy. Once solved for, the two conservation laws give the temperature and electric field, respectively. All surfaces, except the bolt contact surfaces, are cooled by natural convection in the air surrounding the busbar. You can assume that the exposed parts of the bolt do not contribute to the cooling or heating of the device. The electric potential at the upper-right vertical bolt surface is 20 mV and the potential at the two horizontal surfaces of the lower bolts is 0 V. This corresponds to a relatively high and potentially unsafe loading of this type of busbar. More advanced boundary conditions for electromagnetics analysis are available with the AC/DC Module, such as the capability to give the total current on a boundary. A more advanced model that includes multiple busbars in an assembly, as shown in the figure below, can be found in some of the add-on products, including the AC/DC Module and a few of the LiveLink™ products for CAD.

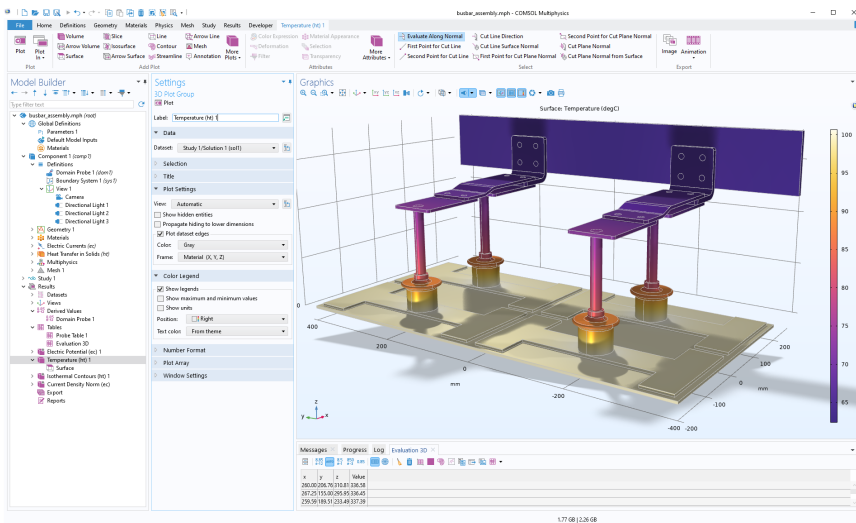

## Busbar Model Overview

More in-depth and advanced topics included in this tutorial are used to show you some of the many options available in COMSOL Multiphysics. The following topics are covered:

- “Parameters, Functions, Variables, and Couplings” on page 136, where you learn how to define functions and nonlocal couplings.
- “Material Properties and Material Libraries” on page 141 shows you how to customize a material and add it to your own material library.

- “Adding Meshes” on page 143 gives you the opportunity to add and define two different meshes and compare them in the **Graphics** window.
- “Adding Physics” on page 146 explores the multiphysics capabilities by adding solid mechanics and laminar flow to the busbar model.
- “Parametric Sweeps” on page 169 shows you how to vary the width of the busbar using a parameter and then solve for a range of parameter values. The result is a plot of the average temperature as a function of the width.
- “Parallel Computing” on page 181 gives you an overview of how to solve on clusters.
- “COMSOL Multiphysics Client–Server” on page 185 gives you an introduction to using the COMSOL Multiphysics client–server mode of operation.

## Model Wizard

- 1 To open the software, double-click the COMSOL Multiphysics icon on the desktop.

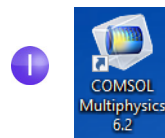

When the software opens, click the **Model Wizard** button. You can also start the **Model Wizard** at any time by selecting **New** from the **File** menu. Then, choose **Model Wizard**.

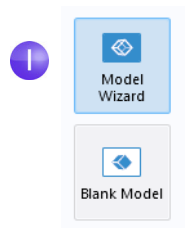

- 2 In the **Select Space Dimension** window, click **3D**.

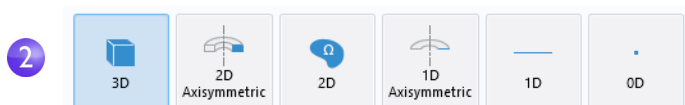



- 3 In the **Select Physics** window, expand **Heat Transfer > Electromagnetic Heating**. Then, right-click **Joule Heating** and choose **Add Physics**. Click the **Study** button.

You can also double-click the selected physics interface or click the **Add** button to add physics.

(Another way to add physics is to open the **Add Physics** window by right-clicking the **Component** node in the **Model Builder** window and selecting **Add Physics**.)

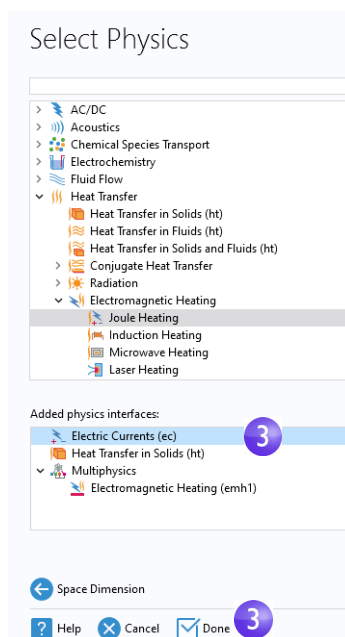
Note that you may have fewer items in your physics list depending on the add-on modules installed. The figure on the right is shown for the case where all add-on modules are installed.



4 In the **Select Study** window, click to select the **Stationary**  study type.

Click the **Done** button.

Choosing a stationary study means that we are solving for the steady-state temperature of the busbar when it has reached thermal equilibrium with its surroundings.

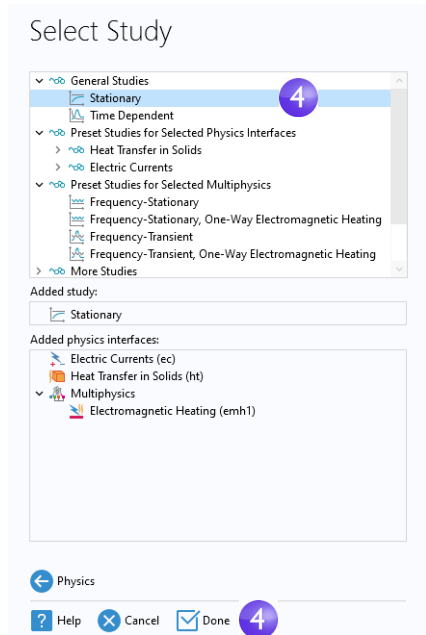

A preconfigured **Study** has solver and equation settings adapted to the selected combination of physics interfaces; in this example, **Joule Heating**.

Note that you may have fewer study types in your study list depending on the installed add-on modules.

- ⚠ A physics interface is a user interface for a specific physics area that defines the equations together with settings for mesh generation, solvers, visualization, and results. A multiphysics interface is a combination of physics interfaces together with multiphysics couplings. The **Joule Heating** multiphysics interface consists of two physics interfaces, **Electric Currents** and **Heat Transfer in Solids**, together with the multiphysics coupling **Electromagnetic Heating** that appear in the **Multiphysics** branch. This method of mixing physics is very flexible and makes it possible to use all the capabilities of the participating single-physics interfaces for multiphysics purposes.

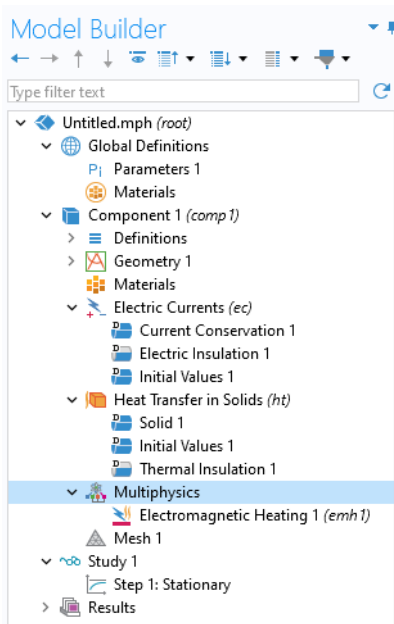



## Global Definitions

---



To save time, it is recommended that you load the geometry from a file. In that case, you can skip to “Geometry” on page 85.

On the other hand, if you want to draw the geometry yourself, the **Global Definitions** node is where you define the parameters. First, complete steps 1 through 3 below to define the parameter list for the model. Then, follow step 4 and skip to the section “Appendix A — Building a Geometry” on page 214.

The **Global Definitions** node  in the **Model Builder** window stores **Parameters**, **Variables**, and **Functions** with a global scope. The model tree can hold several model components simultaneously, and the definitions with a global scope are made available for all components. In this particular example, there is only one **Component** node in which the parameters are used. If you wish to limit the scope to this single component, you could define, for example, **Variables** and **Functions** in the **Definitions** subnode, available directly under the corresponding **Component** node. However, no **Parameters** can be defined here because **Parameters** that are defined under **Global Definitions** are always global.

Since you will run a parametric study of the geometry later in this example, define the geometry using parameters from the start. In this step, enter parameters for the length of the lower part of the busbar,  $L$ ; the radius of the titanium bolts,  $\text{rad}_1$ ; the thickness of the busbar,  $\text{tbb}$ ; and the width of the device,  $\text{wbb}$ .

You will also add the parameters that control the mesh,  $\text{mh}$ ; a heat transfer coefficient for cooling by natural convection,  $\text{htc}$ ; and a value for the voltage across the busbar,  $\text{Vtot}$ .

- 1 Under **Global Definitions** , choose **Parameters** . In the **Parameters** table, click the first row under **Name** and enter  $L$ .
- 2 Click the first row under **Expression** and enter the value of  $L$ ,  $9[\text{cm}]$ . You can enter the unit inside the square brackets.
- 3 Continue adding the other parameters:  $\text{rad}_1$ ,  $\text{tbb}$ ,  $\text{wbb}$ ,  $\text{mh}$ ,  $\text{htc}$ , and  $\text{Vtot}$  according to the **Parameters** list below. It is a good idea to enter descriptions for

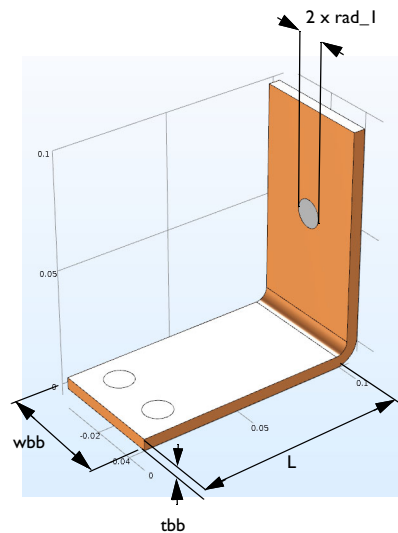

variables in case you want to share the model with others and for your own future reference.

Parameters			
Name	Expression	Value	Description
L	9[cm]	0.09 m	Length
rad_1	6[mm]	0.006 m	Bolt radius
tbb	5[mm]	0.005 m	Thickness
wbb	5[cm]	0.05 m	Width
mh	3[mm]	0.003 m	Maximum element size
htc	5[W/m^2/K]	5 W/(m^2·K)	Heat transfer coefficient
Vtot	20[mV]	0.02 V	Applied voltage

Click the **Save** button  on the Quick Access Toolbar and name the model busbar.mph or use the corresponding **File** menu option. Then, go to “Appendix A — Building a Geometry” on page 214.

## The Auto Completion and Find Tools

The model tree contains a large number of parameters and variables. To make it easier to find them, you can use the auto completion and find tools as described below.

### AUTO COMPLETION

You can use Ctrl+Space for auto completion of parameter and variable names. For example, in the **Parameters** table, if you click an empty **Expression** field and then press Ctrl+Space, you will get a list of parameters and variables, as shown in the figure below.

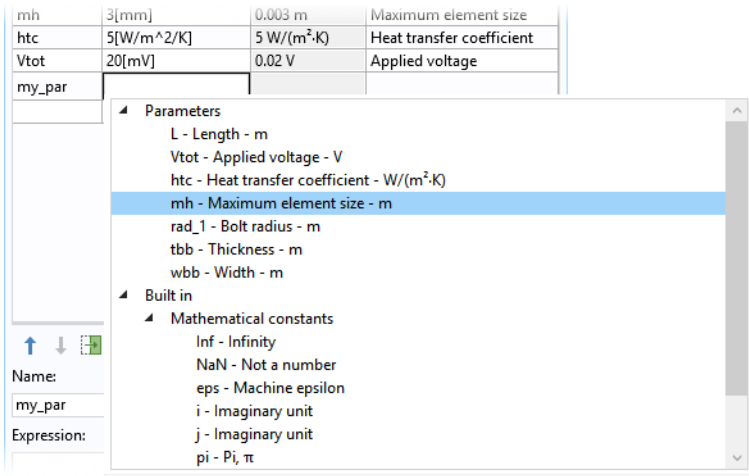

This functionality is also available for other edit fields in the **Model Builder** window.

# FIND

To find parameters, variables, as well as other strings in the model tree, you can click the **Find** button in the **Quick Access Toolbar** or use the keyboard shortcut Ctrl+F. This opens the **Find and Replace** window.

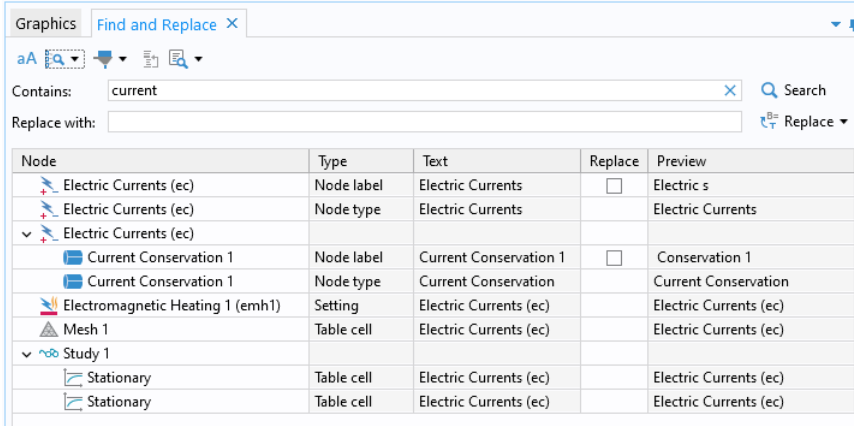

The results of the search are displayed below the **Contains** and **Replace with** fields. The results in this example are coming from the completed busbar model by searching for the string current.

You can double-click any of the rows in this window to open the corresponding **Settings** window.

## Geometry

This section describes how the geometry can be opened from the Application Libraries. The physics, study, parameters, and geometry are included with the model file you are about to open.

- 1 Select **Application Libraries**  from the **Windows** drop-down menu in the **Home** tab. You can also access the **Application Libraries** from the **File** menu.

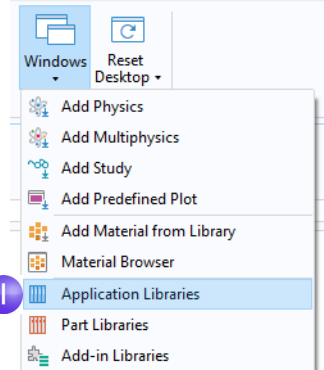

- 2 In the **Application Libraries** tree under **COMSOL Multiphysics > Multiphysics**, select **busbar\_geom**.



To open the file, you can:

- Double-click the name
- Right-click and select an option from the menu
- Click one of the buttons under the tree

You can select **No** if prompted to save Untitled.mph.

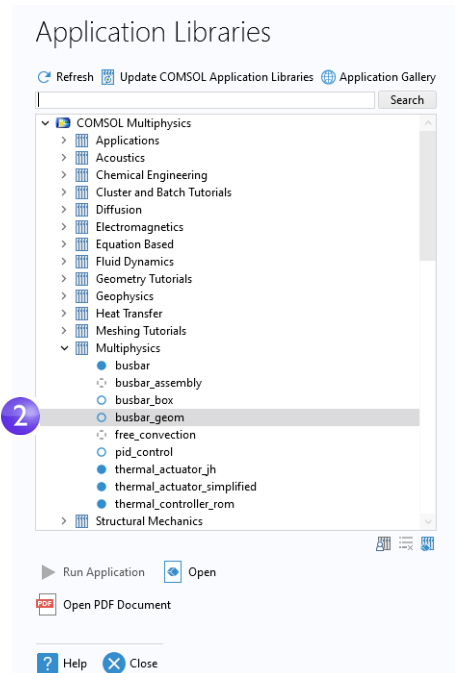
The geometry in this file is parameterized. In the next few steps, we will experiment with different values for the width parameter, *wbb*.





3 Under **Global Definitions** , click the **Parameters** node .

In the **Settings** window for **Parameters**, click in the **Expression** column for the **wbb** parameter and enter **10[cm]** to change the value of the busbar width.

3

Name	Expression	Value
L	9[cm]	0.09 m
rad_1	6[mm]	0.006 m
tbb	5[mm]	0.005 m
wbb	10[cm]	0.1 m
mh	6[mm]	0.006 m
htc	5[W/m^2/K]	5 W/(m^2·K)
Vtot	20[mV]	0.02 V

4 In the **Model Builder** window, under **Component 1 > Geometry 1**, click the **Form Union** node  and then the **Build**

**All** button in the **Settings** window  to rerun the geometry sequence. You can also use the ribbon and click **Build All** from the **Geometry** group in the **Home** tab.

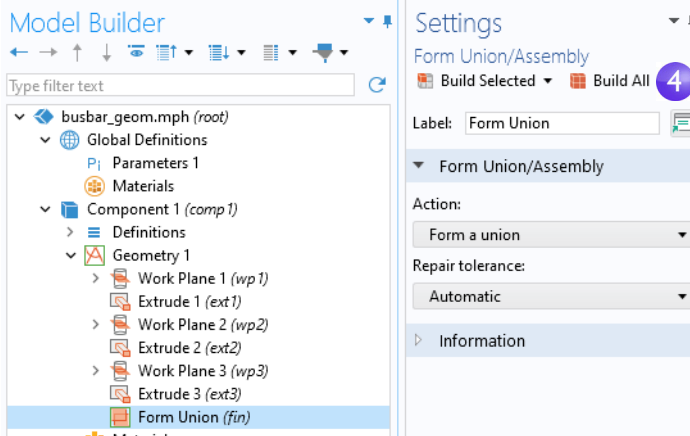

- 5 In the **Graphics** toolbar, click the **Zoom Extents** button  to see the wider busbar in the **Graphics** window.

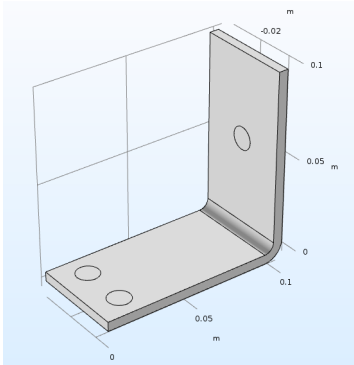
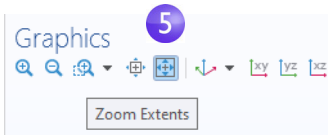

wbb = 5cm

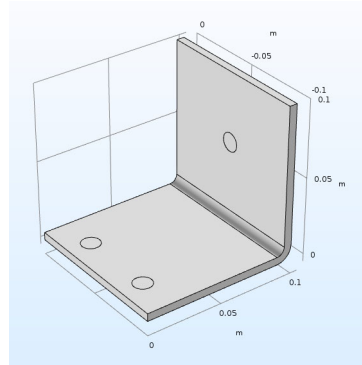

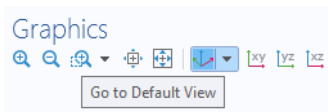

wbb = 10cm

- 6 Experiment with the geometry in the **Graphics** window:
- To rotate the busbar, click and drag the pointer anywhere in the **Graphics** window.
  - To move it, right-click and drag.
  - To zoom in and out, click the scroll wheel, continue holding it, and drag.
  - To get back to the original position, click the **Go to Default 3D View** button  on the toolbar.



- 7 Return to the **Parameters** table and change the value of wbb back to 5 [cm].

- 8 In the **Model Builder** window, click the **Form Union** node  and then click the **Build All** button  to rerun the geometry sequence.

- 9 On the **Graphics** toolbar, click the **Zoom Extents** button .

Parameters		
Name	Expression	Value
L	9[cm]	0.09 m
rad_1	6[mm]	0.006 m
tbb	5[mm]	0.005 m
wbb	5[cm]	0.05 m
mh	6[mm]	0.006 m
htc	5[W/m <sup>2</sup> /K]	5 W/(m <sup>2</sup> ·K)
Vtot	20[mV]	0.02 V



**10** If you built the geometry yourself, you are already using the file busbar.mph, but if you opened the file from the **Application Libraries** window, select **Save As from the File menu** and rename the model busbar.mph.

After creating or importing the geometry, it is time to define the materials.





## Materials

The **Materials** node  stores the material properties for all physics and geometrical domains in a **Component** node. The busbar is made of copper and the bolts are made of a titanium alloy. Both of these materials are available from the **Built-In** material database.

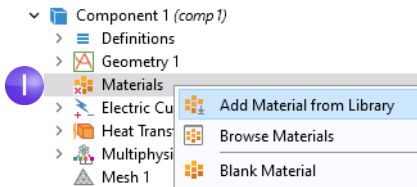
- 1 In the **Model Builder** window, right-click **Component 1 > Materials**  and select **Add Material from Library** . By default, the window will open on the right-hand side of the desktop. You can move the window by clicking on the window title and then dragging it to a new location. While dragging the window, you will be presented with several options for docking.





- 1  The **Materials** node will show a red  $\times$  in the lower-left corner if you try to solve without first defining a material, which we will go over in the next few steps.

- 2 In the **Add Material** window, expand the **Built-In** materials folder and locate **Copper**. Right-click **Copper**  and select **Add to Component 1**. Alternatively, you can double-click.

A **Copper** node is added to the **Model Builder** window.

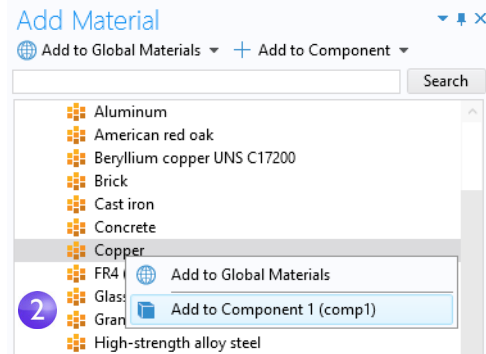
- 3 In the **Add Material** window, scroll to **Titanium beta-215** in the **Built-In** material folder list. Right-click and select **Add to Component 1**.



- 4 In the **Model Builder** window, collapse the **Geometry 1** node  to get an overview of the model.

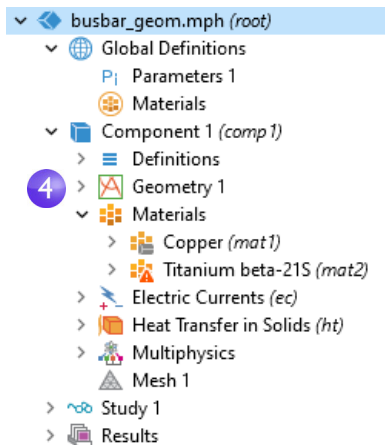

At this stage, the **Materials** node may display one or more red × symbols depending on the active selection. These will disappear in the next few steps.

- 5 Under the **Materials** node, click **Copper** .

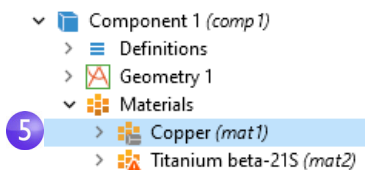

- 6 In the **Settings** window for **Material**, examine the **Material Contents** section.

Property	Variable	Value	Unit	Property group
<input checked="" type="checkbox"/> Electrical conductivity	sigma_iso ; si...	5.998e7[S/m]	S/m	Basic
<input checked="" type="checkbox"/> Heat capacity at constant pressure	Cp	385[J/(kg*K)]	J/(kg*K)	Basic
<input checked="" type="checkbox"/> Relative permittivity	epsilon_iso ; ...	1	1	Basic
<input checked="" type="checkbox"/> Density	rho	8960[kg/m^3]	kg/m^3	Basic
<input checked="" type="checkbox"/> Thermal conductivity	k_iso ; kii = k...	400[W/(m*K)]	W/(m*K)	Basic
Relative permeability	mu_iso ; mu...	1	1	Basic
Coefficient of thermal expansion	alpha_iso ; al...	17e-6[1/K]	1/K	Basic
Young's modulus	E	110e9[Pa]	Pa	Young's modulus and Poisson's ratio
Poisson's ratio	nu	0.35	1	Young's modulus and Poisson's ratio
Reference resistivity	rho0	1.72e-8[ohm*m]	Ω·m	Linearized resistivity
Resistivity temperature coefficient	alpha	0.0039[1/K]	1/K	Linearized resistivity
Reference temperature	Tref	298[K]	K	Linearized resistivity

The **Material Contents** section has useful information about the material property usage of a model. Properties that are both required by the physics and available from the material are marked with a check mark . Properties

required by the physics but missing in the material are marked with a warning sign . A property that is available but not used in the model is unmarked.

 The **Coefficient of thermal expansion**, **Young's modulus**, and **Poisson's ratio** properties in the table above are not used but will be needed later when heat-induced stresses and strains are added to the model.

Because the copper material is added first, by default, all parts have copper material assigned. In the next step, you will assign titanium properties to the bolts, which override the copper material assignment for those parts.

**7** In the **Model Builder** window, click **Titanium beta-21S** .

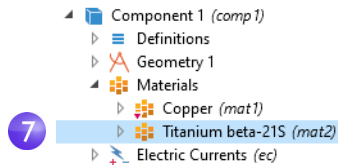

- 8 Select **All Domains** from the **Selection** list and then click domain 1 in the list. Now remove domain 1 from the selection list.

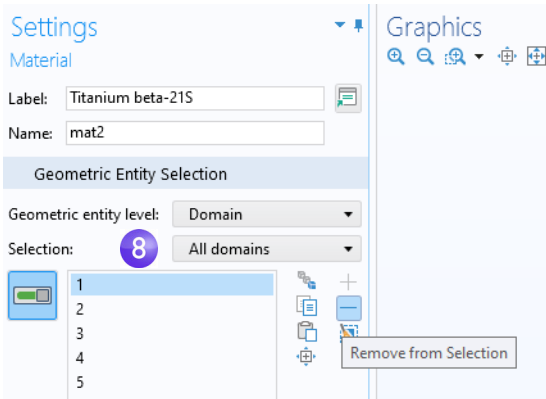

To remove a domain from the selection list (or any geometric entity, such as boundaries, edges, or points), you can use either of these two methods:

- Click domain 1 in the selection list found in the **Settings** window for **Material**. Then, click the **Remove from Selection** button – or press Delete on your keyboard.
- Alternatively, in the **Graphics** window, click domain 1 to remove it from the selection list.

- 8 The domains 2, 3, 4, 5, 6, and 7 are highlighted in blue.

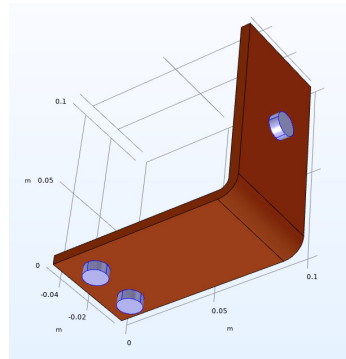
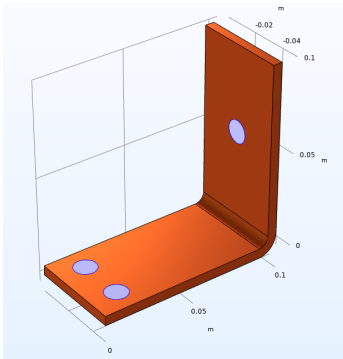



You can enable and disable material color and texture from the **Color** toolbar button in the **Graphics** window. To render the copper components using a realistic color, select **Show Material Color and Texture**. This will also enable material-true rendering of other materials. Here, you can also enable coloring of selections by selecting **Show Selection Colors**.

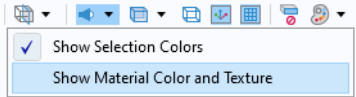

The figures below show the **Settings** and **Graphics** windows corresponding to a selection where a color (pink) other than the default has been used. There is also a second selection (not shown) with another color (green).

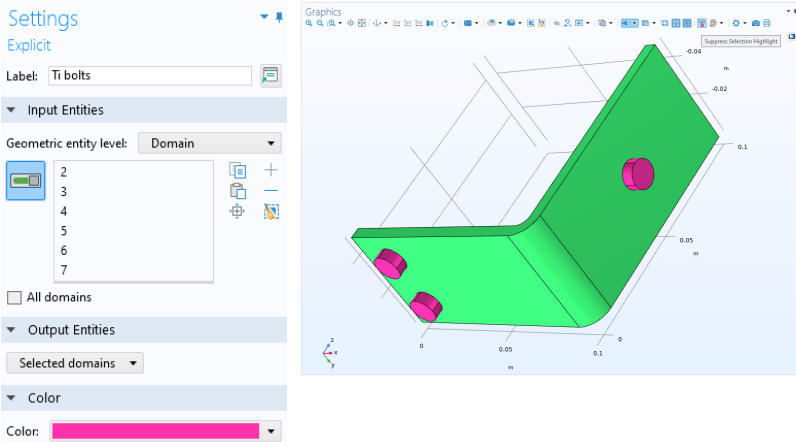

Note that to see the color while creating a selection, you need to click the **Suppress Selection Highlight** button in the **Graphics** toolbar. For more information on **Selections**, see page 149.

To further increase the level of realism in material rendering you can enable **Environment Reflections** from the **Scene Light** menu button in the **Graphics** toolbar. From this menu you can choose an **Indoor Environment** or **Outdoor Environment**. You can also enable effects such as **Direct Shadows** and **Floor Shadows**.



The corresponding image, known as a skybox image, will be reflected in the material, thereby increasing the level of realism. This is particularly visible when the material is a metal, as shown in the figure below.

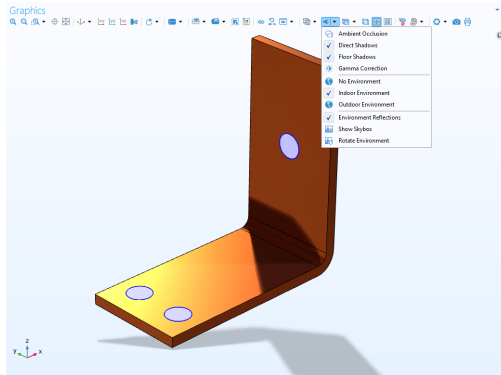

By selecting the **Show Skybox** option you can display the corresponding skybox image used for the environment reflection.

For best results you will need a graphics card that supports **OpenGL**. See also “Graphics and Plot Windows” on page 14. Not all of these visualization options will be used in the remainder of this example.

- 9 In the **Settings** window for **Material**, be sure to inspect the **Material Contents** section for the titanium material. All of the properties used by the physics should have a check mark .

Settings  
Material

Label: Titanium beta-215  
Name: mat2

Geometric Entity Selection

Geometric entity level: Domain  
Selection: Manual

2  
3  
4  
5  
6  
7

Override  
Material Properties  
Material Contents

Property	Variable	Value	Unit
<input checked="" type="checkbox"/> Electrical conductivity	sigma...	7.407e5[S/m]	S/m
<input checked="" type="checkbox"/> Heat capacity at constant pressure	Cp	710[J/(kg*K)]	J/(kg*K)
<input checked="" type="checkbox"/> Relative permittivity	epsilo...	1	1
<input checked="" type="checkbox"/> Density	rho	4940[kg/m^3]	kg/m^3
<input checked="" type="checkbox"/> Thermal conductivity	k_iso ;...	7.5[W/(m*K)]	W/(m...)
Relative permeability	mur_is...	1	1
Coefficient of thermal expansion	alpha_...	7.06e-6[1/K]	1/K
Young's modulus	E	105e9[Pa]	Pa
Poisson's ratio	nu	0.33	1

- 10 Close the **Add Material window** either by clicking the icon in the upper-right corner or by clicking the **Add Material** toggle button  in the **Materials** group of the ribbon **Home** tab.

Add Material



Add to Global Materials + Add to Component

Search

Recent Materials  
Material Library  
Built-in

# Physics and Boundary Conditions

Next, you will inspect the physics domain settings and set the boundary conditions for the heat transfer problem and the conduction of the electric current.

In the **Model Builder** window, examine the default physics nodes of the multiphysics interface for **Joule Heating**. First, collapse the **Materials** node. Then, click the arrows next to the **Electric Currents** , **Heat Transfer in Solids** , and **Multiphysics**  nodes to expand them.

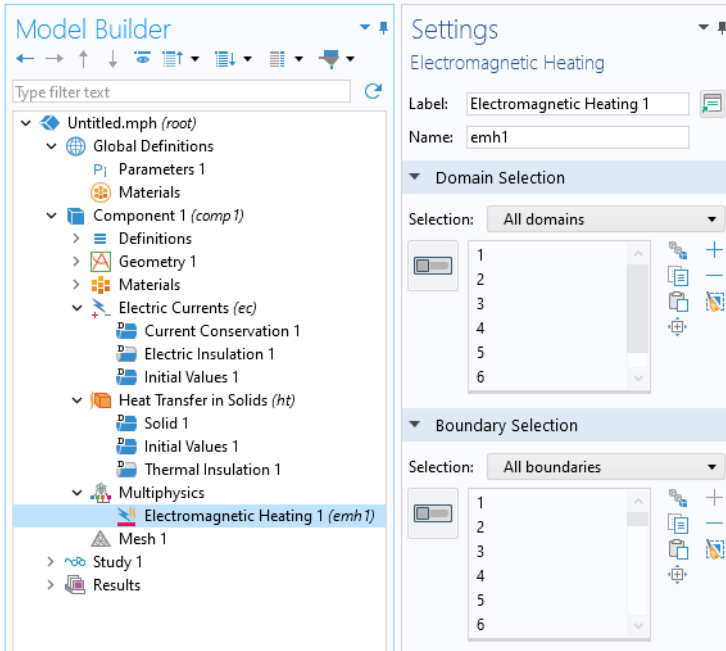

The **D** in the upper-left corner of a node's icon () means it is a default node.

The equations that are being solved are displayed in the **Equation** section of the **Settings** windows of the respective physics nodes.

The default equation form, for example, whether it should be a stationary or transient equation, is inherited from the study added in the Model Wizard. In this case, the study is stationary and the equation form is the stationary version of the equation system for Joule heating. For the Joule Heating multiphysics interface, the equation system has the temperature and electric potential as dependent variables.



! To always display the equations in the **Settings** windows, click the **Show More Options** button (☰) on the **Model Builder** toolbar and select **Equation Sections** so that a check mark appears next to it.

The **Heat Transfer in Solids** and **Electric Currents** nodes have the settings for heat conduction and current conduction, respectively.

Under the **Electric Currents** node, the **Current Conservation** node represents the conservation of electric current at the domain level and the **Electric Insulation** node contains the default boundary condition for **Electric Currents**.

Under the **Heat Transfer in Solids** node, the domain level **Solid** node represents the conservation of heat and the **Thermal Insulation** node contains the default boundary condition for **Heat Transfer in Solids**. The heat source for the Joule heating effect is set in the **Electromagnetic Heating** node under the **Multiphysics** node. The **Initial Values** node, found in both the **Electric Currents** and **Heat Transfer in Solids** interfaces, contains initial guesses for the nonlinear solver for stationary problems and initial conditions for time-dependent problems.

Now, define the boundary conditions.

| Right-click the **Heat Transfer in Solids** node (🔍). In the second section of the context menu — the boundary section — select **Heat Flux**.

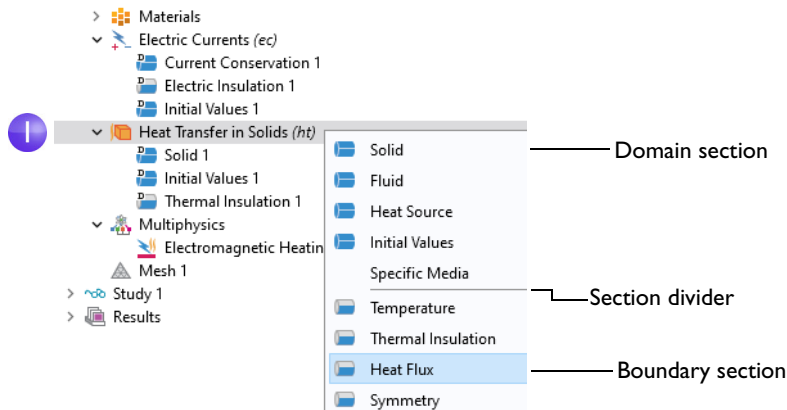
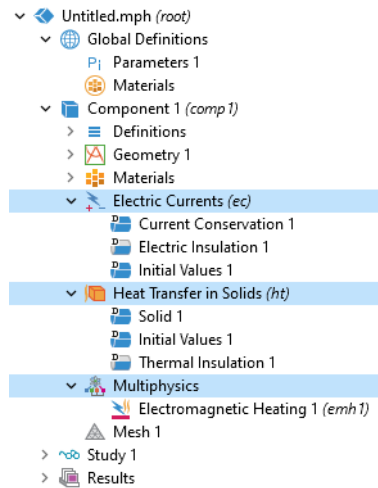

- 2 In the **Settings** window for **Heat Flux**, select **All boundaries** from the **Selection** list.

Assume that the circular bolt boundaries are neither heated nor cooled by the surroundings.

In the next step, you will remove the selection of these boundaries from the heat flux selection list, which leaves them with the default **Thermal Insulation** boundary condition for the **Heat Transfer in Solids** interface.

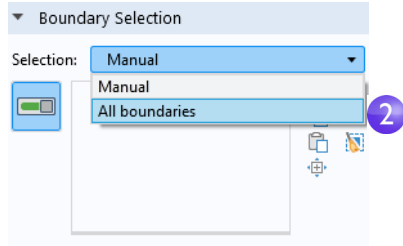

- 3 Rotate the busbar to view the back. Move the mouse pointer over one of the circular titanium bolt surfaces to highlight it in green. Click the bolt surface to remove this boundary selection from the **Selection** list. Repeat this step to remove the other two circular bolt surfaces from the selection list. Boundaries 8, 15, and 43 are removed.

- 3 Cross-check: Boundaries 8, 15, and 43 are removed from the Selection list.

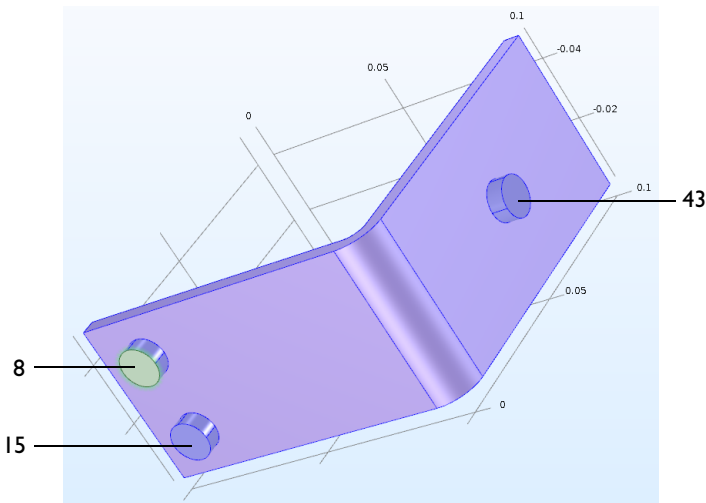

- 4 In the **Settings** window for **Heat Flux**, in the **Heat Flux** section, select **Convective heat flux** as the **Flux type**. Enter  $h_{tc}$  in the **Heat transfer coefficient** field,  $h$ .

This parameter was either entered in the **Parameter** table in “Global Definitions” on page 81 or imported with the geometry.

4

- ! More advanced boundary conditions for heat transfer analysis are available with the Heat Transfer Module. Examples include the capability to give the total deposited power or to set boundary conditions for common natural convection scenarios such as for a horizontal or vertical wall.

Continue by setting the boundary conditions for the electric current according to the following steps:

- 5 In the **Model Builder** window, right-click the **Electric Currents** node . In the second section of the context menu — the boundary section — select **Electric Potential**. An **Electric Potential** node is added to the model tree.

- 6 Move the mouse pointer over the circular face of the single titanium bolt to highlight it and then click to add it (boundary 43) to the **Selection** list.

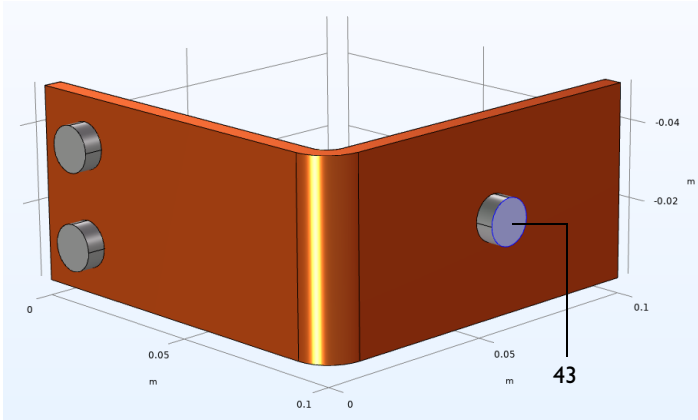

6

- 7 In the **Settings** window for **Electric Potential**, enter  $V_{tot}$  in the **Electric potential** field.

The last step is to set the surfaces of the two remaining bolts to ground.

7



- 8 In the **Model Builder** window, right-click the **Electric Currents** node. In the boundary section of the context menu, select **Ground**. A **Ground** node is added to the model tree. The model tree node sequence should now match this figure.

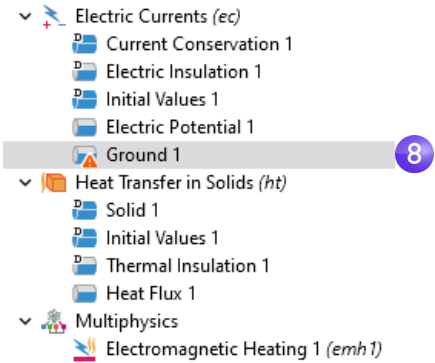

The “warning” attribute displayed on the **Ground** node indicates that its boundary selection is empty. The next step will be to select boundaries.

9 In the **Graphics** window, click one of the remaining bolts to add it to the **Selection** list.



Cross-check: Boundaries 8 and 15.

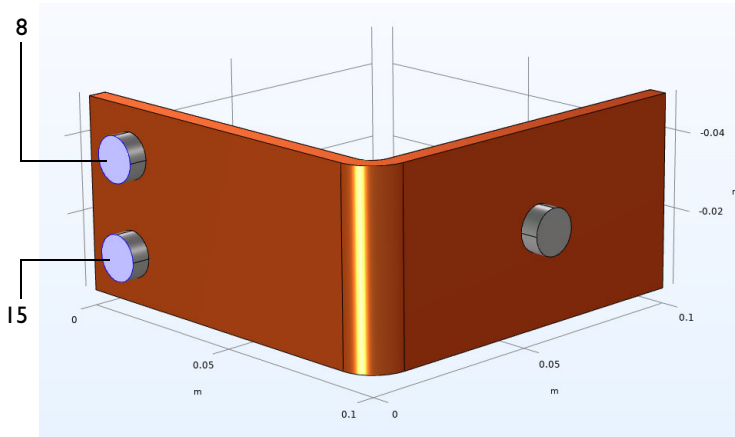

Repeat this step to add the last bolt. Boundaries 8 and 15 are added to the selection list for the **Ground** boundary condition.

10 On the **Graphics** toolbar, click the **Go to Default View** button .

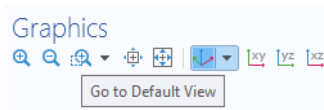

More advanced boundary conditions for electromagnetics analysis are available with the AC/DC Module, such as the capability to give the total current on a boundary.

## COMBINING PHYSICS INTERFACES MANUALLY

As an alternative to using the preconfigured **Joule Heating** multiphysics interface, you can manually combine the **Electric Currents** and **Heat Transfer in Solids** interfaces. For example, you can start by setting up and solving the model for

**Electric Currents** and then subsequently add **Heat Transfer in Solids**. In that case, you right-click the **Multiphysics** node to add the required multiphysics couplings.

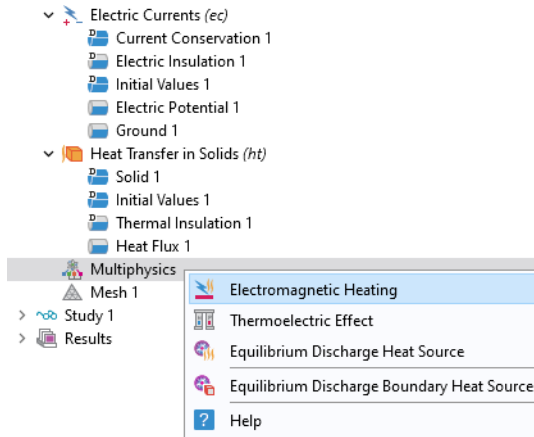

As an alternative, you can click the **Add Multiphysics** button in the **Physics** tab on the ribbon and select a suggested multiphysics coupling in the **Add Multiphysics** window.

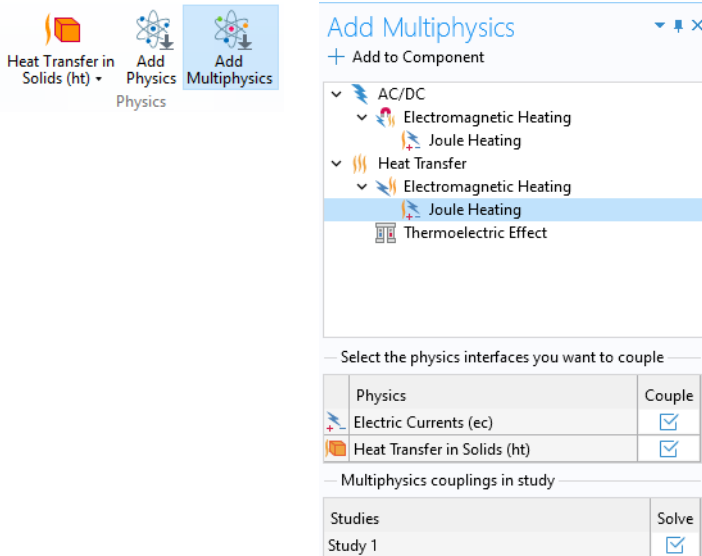



## Mesh

---

The simplest way to mesh is to create an unstructured tetrahedral mesh, which is perfect for the busbar model. Alternatively, you can create several meshing sequences, as shown in “Adding Meshes” on page 143.

! A physics-controlled mesh is created by default. In most cases, it is possible to skip to the **Study** node and just solve to get a solution. For this exercise, the settings are investigated in order to parameterize the mesh settings.

- 1 In the **Model Builder** window, click the **Mesh 1** node . In the **Settings** window for **Mesh**, select **User-controlled mesh** from the **Sequence Type** list.
- 2 Under **Mesh 1**, click the **Size** node .

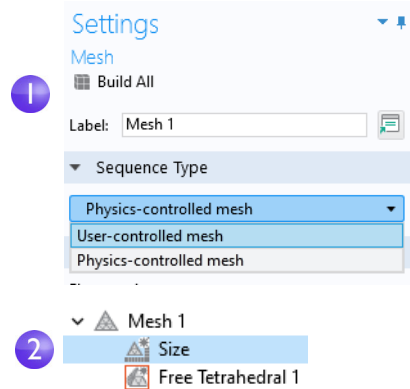

3 In the **Settings** window for **Size**, in the **Element Size** section, click the **Custom** button.

Under **Element Size Parameters**, enter:

- $mh$  in the **Maximum element size** field. Note that  $mh$  is 3 mm — the value entered earlier as a global parameter. By using the parameter  $mh$ , element sizes are limited by this value.
- $mh-mh/3$  in the **Minimum element size** field. The **Minimum element size** is slightly smaller than the maximum size.
- 0.2 in the **Curvature factor** field. The **Curvature factor** determines the number of elements on curved boundaries; a lower value gives a finer mesh.

3

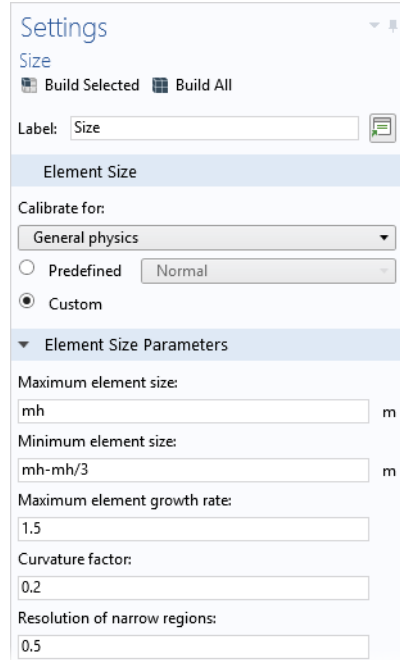

The other two parameters are left unchanged.

The **Maximum element growth rate** determines how fast the elements should grow from small to large over a domain. The larger this value is, the larger the growth rate. A value of 1 does not give any growth.

For **Resolution of narrow regions**, a higher value will generally result in a finer mesh.

The asterisk (\*) that displays in the upper-right corner of the **Size** node  indicates that the node is being edited.



- 4 Click the **Build All** button  in the **Settings** window for **Size** to create the mesh, as in this figure:

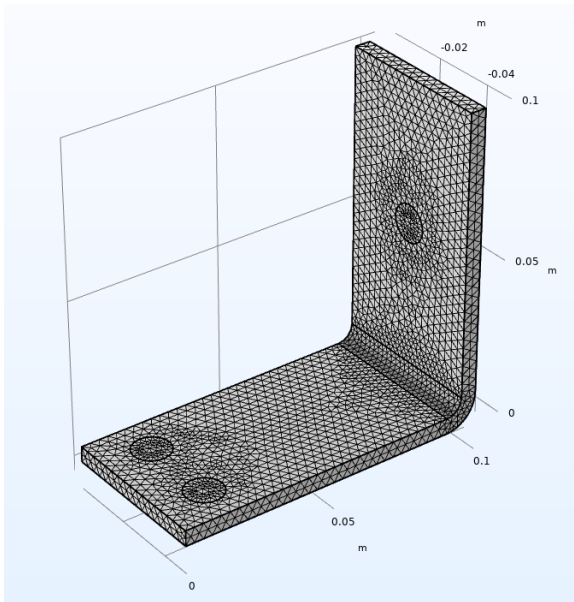

You can also click **Build Mesh** in the **Home** tab of the ribbon.

## Study

---

- I To run a simulation, in the **Model Builder** window, right-click **Study 1** and choose **Compute** = . You can also press F8 or click **Compute** on the ribbon **Home** tab.

The **Study** node  automatically defines a solution sequence for the simulation based on the selected physics and study type. In this case, the simulation only takes a few seconds to solve. During the

solution process, two **Convergence** plots are generated and are available from tabs next to the **Graphics** window. These plots show the convergence progress of the different solver algorithms engaged by the **Study**.

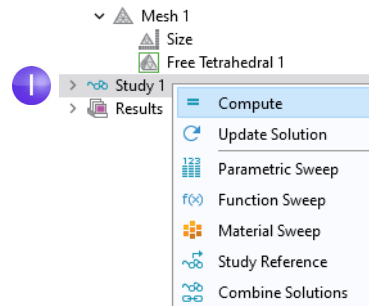





## Results

By default, in the **Results** node, four plot groups are generated: a **Volume** plot of the **Electric Potential**, a **Multislice** and **Streamline Multislice** plot of the **Electric Field Norm** (the magnitude of the electric field) and **Electric Field**, and a **Volume** plot of the **Temperature**.

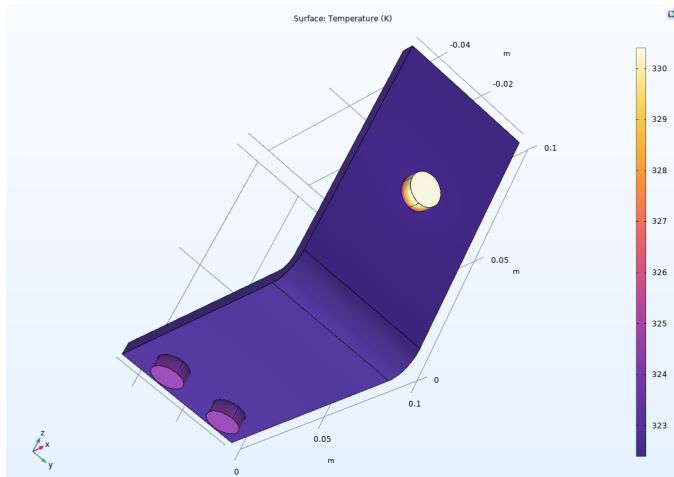
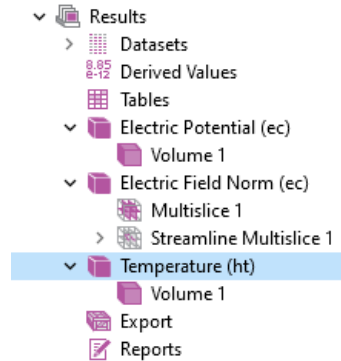
Click **Results > Temperature**  to view the **Temperature** plot in the **Graphics** window. The temperature difference in the device is less than 10 K due to the high thermal conductivity of copper and titanium. The temperature variations are largest in the top bolt, which conducts double the amount of current compared to the two lower bolts. The temperature is substantially higher than the ambient temperature of 293 K.

- 1 Click and drag the image in the **Graphics** window to rotate and view the back of the busbar.



- 2 In the **Graphics** toolbar, click the **Go to Default 3D View** button .
- You can now manually set the color table range to visualize the temperature difference in the copper part.
- 3 In the model tree, expand the **Results > Temperature** node  and click the **Volume** node .

- 4 In the **Settings** window for **Volume**, click **Range** to expand the section. Select the **Manual color range** check box and enter 324 in the **Maximum** field (keep the default for **Minimum** and replace the default for **Maximum**). Click the **Plot** button  in the **Settings** window for **Volume**.

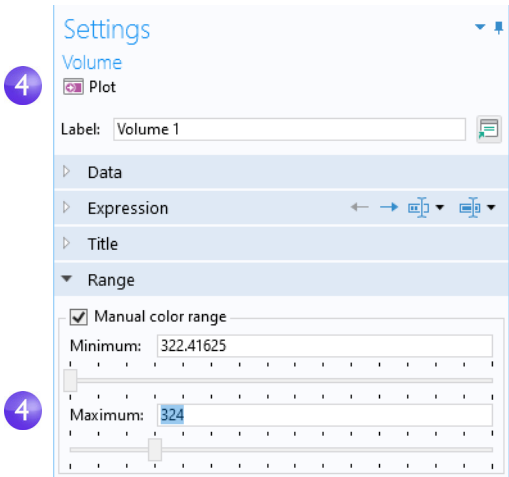

- 5 On the **Graphics** toolbar, click the **Zoom Extents** button  to view the updated plot.
- 6 Click and drag in the **Graphics** window to rotate the busbar and view the back.

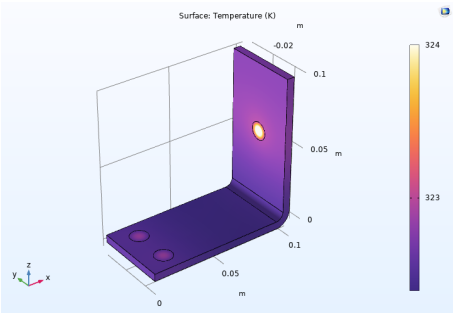

5

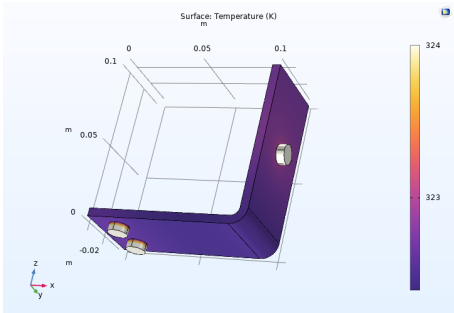

6

The temperature distribution is laterally symmetric with a vertical mirror plane running between the two lower titanium bolts and cutting through the center of the upper bolt. In this case, the model does not require much computing power and you can model the entire geometry. For more complex models, you can consider using symmetries to reduce the computational requirements.

Select **Go to Default View** on the toolbar in the **Graphics** window .

Then, generate a **Surface** plot that shows the current density in the device.

- 1 In the **Model Builder** window, right-click **Results** and add a **3D Plot Group**. In the **Label** field, enter **Current Density** to give the plot group a descriptive name. Right-click **Current Density** (former **3D Plot Group 4**) and add a **Surface** node.

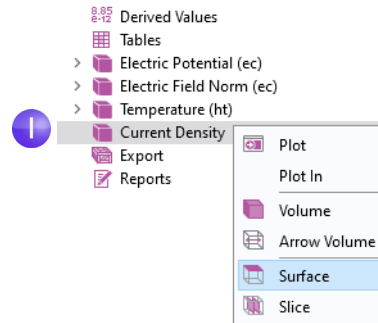

- 2 In the **Settings** window for **Surface** under **Expression**, click the **Replace Expression** button. Go to **Model > Component 1 > Electric Currents > Currents and charge > ec.normJ - Current density norm - A/m<sup>2</sup>** and double-click or press Enter to select.

ec.normJ is the variable for the magnitude, or absolute value, of the current density vector. You can also type ec.normJ in the **Expression** field when you know the variable name or, alternatively, use the auto completion functionality by typing norm and then pressing Ctrl+Space to get a variable name suggestion.

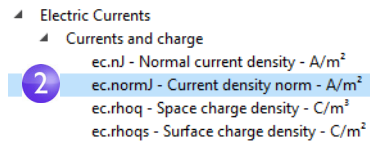

2

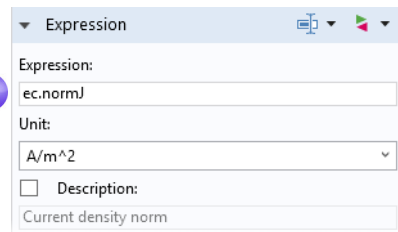

- 3 Click the **Plot** button.

The plot that displays in the **Graphics** window is almost uniform in color due to the high current density at the contact edges with the bolts. The next step is to manually change the color table range to visualize the current density distribution.

- 4 In the **Settings** window for **Surface** under **Range**, select the **Manual color range** check box. Enter  $1e6$  in the **Maximum** field and replace the default.

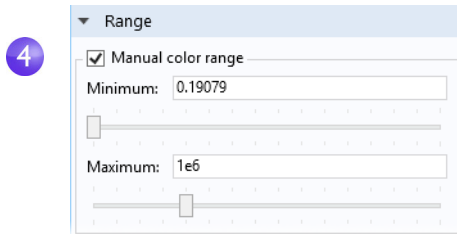

- 5 Click the **Plot** button .

The resulting plot shows that the current takes the shortest path in the 90-degree bend in the busbar. Notice that the edges of the busbar outside of the bolts are hardly carrying any current.

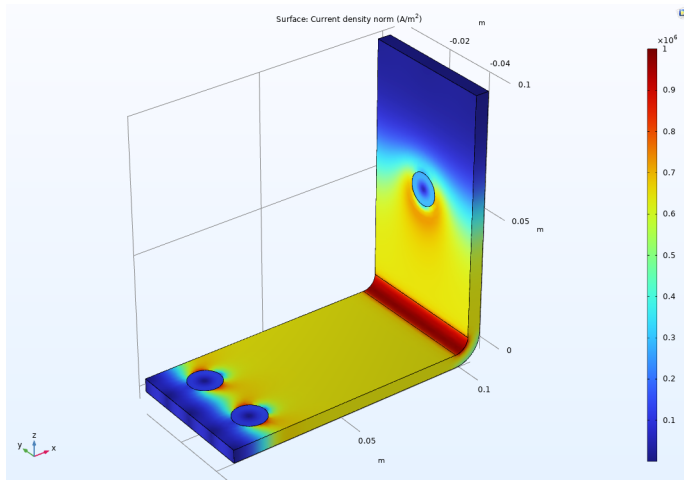

- 6 Click and drag the busbar in the **Graphics** window to view the back. Continue rotating the image to see the high current density around the contact surfaces of each of the bolts.

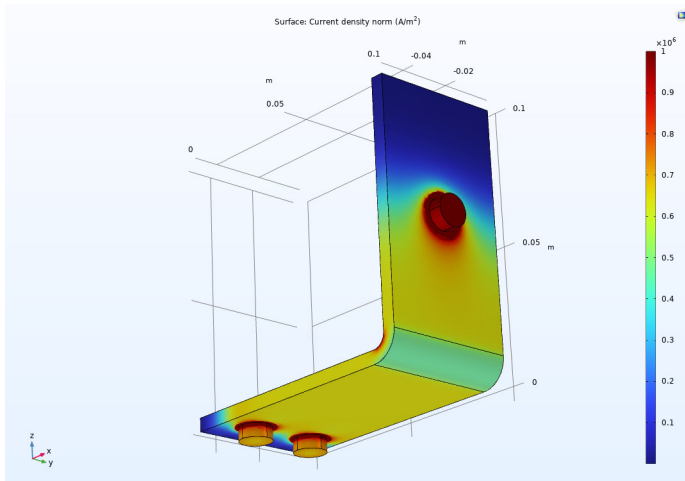

When you are done, click the **Go to Default View** button  on the **Graphics** toolbar.

## GETTING THE MAXIMUM AND MINIMUM TEMPERATURE

You can easily obtain the maximum and minimum temperature values in the busbar, including their locations.

1 Right-click **Results > Temperature** and select **More Volume Plots > Max/Min Volume**.

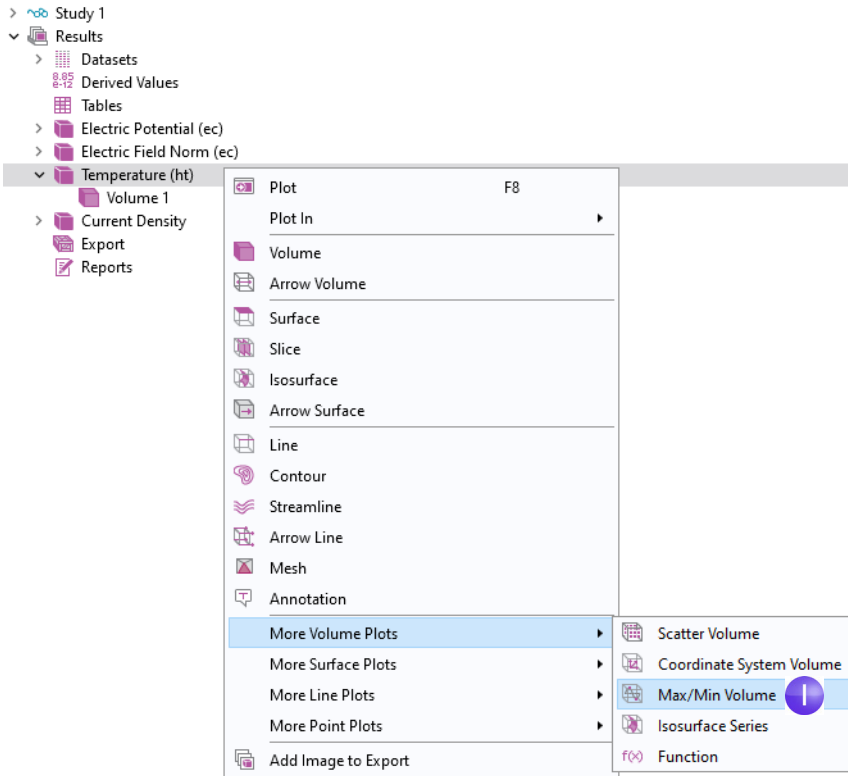

2 In the **Settings** window for **Max/Min Volume** under **Expression**, click the **Replace Expression** button. Go to **Model > Component 1 > Heat Transfer in Solids > Temperature > T - Temperature - K** and double-click or press Enter to select. You



can also search for Temperature in the search field above the tree of postprocessing variables or manually enter T. Click **Plot**.

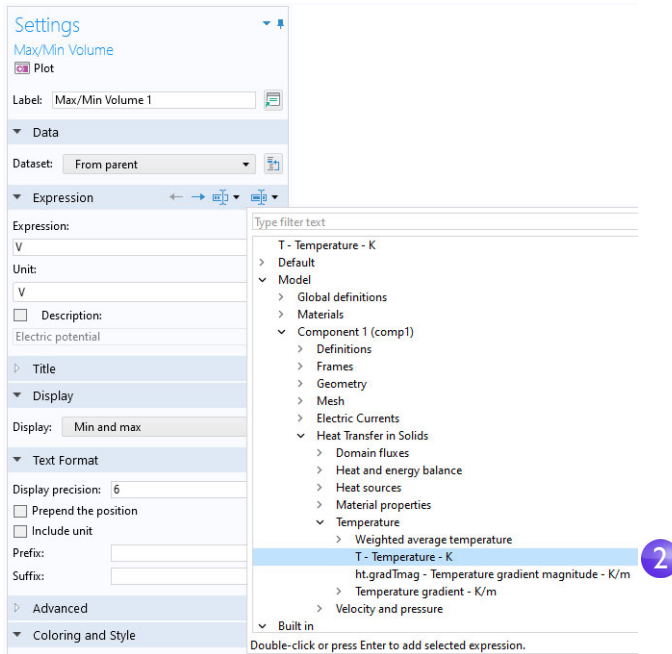

The maximum and minimum values are plotted in the **Graphics** window and their locations and values are displayed in the **Maximum and minimum values**

table. The values may vary a bit depending on the version you are running. For a finer mesh the results will be the same regardless of version.

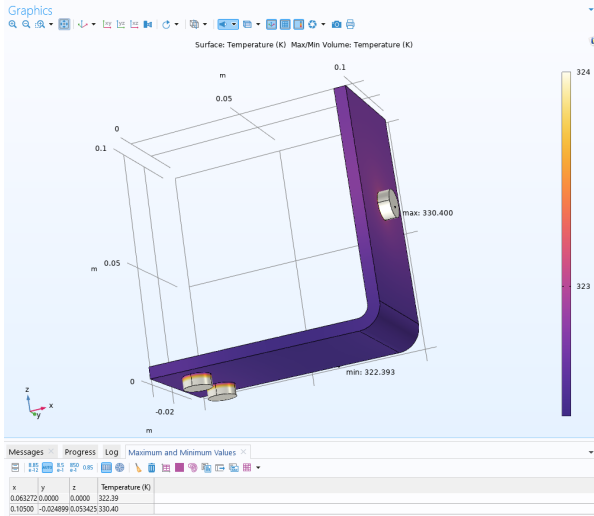

2

As an alternative to the method of plotting the maximum and minimum values described above, you can use the **Derived Values** node or an **Evaluation Group** for a pure numerical output. The following steps show how to use **Derived Values**.

- 3 In the **Results** section of the model tree, right-click the **Derived Values** node and select **Maximum > Volume Maximum** MAX.
- 4 In the **Settings** window for **Volume Maximum**, under **Selection**, choose **All domains**.

- 5 In the first row of the **Expression** table, enter T (unless it is automatically filled out) for the temperature and click **Evaluate** at the top of the **Settings** window.

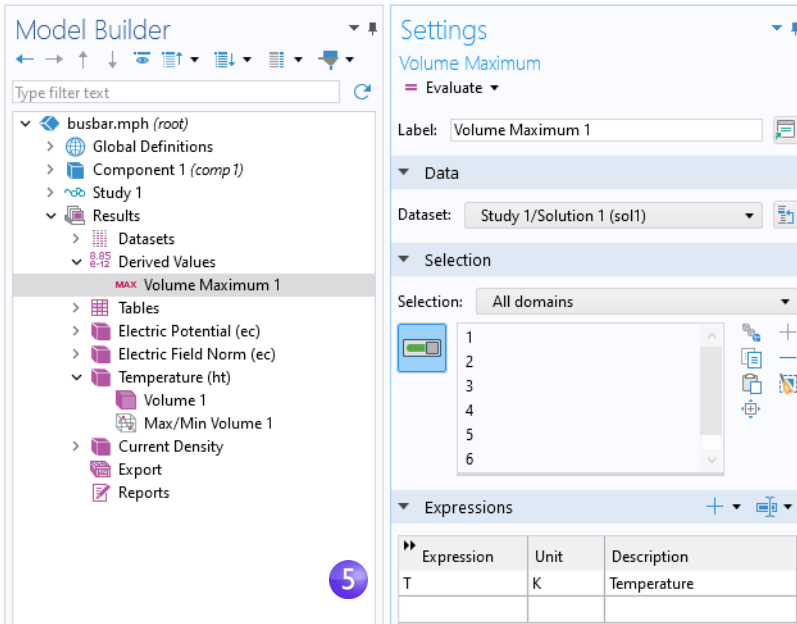

The resulting maximum temperature is shown in **Table I**.

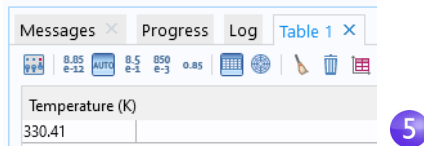

As a next step, you can create a model thumbnail image.

## CREATING MODEL IMAGES FROM PLOTS

With any solution, you can create an image to display when browsing for model files. After generating a plot, click the corresponding plot node in the **Model Builder** window under **Results**. Then, click the root node (the first node in the model tree). In the **Settings** window for the root node, under **Thumbnail**, click **Set from Graphics Window**.



There are two other ways to create images from a plot. One is to click the **Image Snapshot** button  in the **Graphics** window toolbar to directly create an

image. You can also add an **Image** node  to the **Export** node to create an image file. Right-click the plot group of interest and then select **Add Image to Export**.

- ! You can use the **Image Snapshot** button to export **Results** visualizations to glTF™ (file extension .g1b). These files can then be opened in 3D visualization software such as Paint 3D from Microsoft®, as shown in the figure below. (If you are running Windows® 10 or 11, then this may be available in your system. Otherwise, you can download it from the Microsoft® Store.) You can also find glTF™ viewers online that run in web browsers.

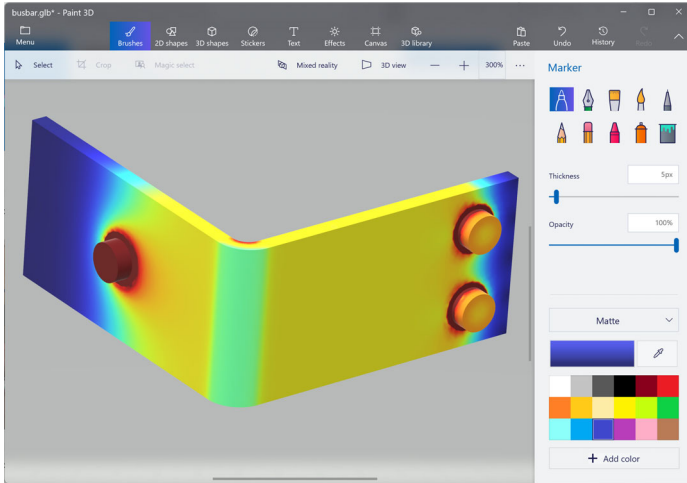

- ! Make sure to save the model at this stage. This version of the model, busbar.mph, is reused and renamed during the next set of tutorials. Alternatively, for the subsequent tutorials, you can use the busbar file in the Application Libraries under **COMSOL Multiphysics > Multiphysics**.

## Building an Application with the Application Builder

---

This section gives a brief introduction to using the Application Builder to create applications, using the busbar model to demonstrate. Each application will have a specialized user interface dedicated to interacting with the busbar model that includes input fields for the length, width, and applied voltage. The outputs will be the maximum temperature and a temperature plot.

In this introduction, you will learn how to use the New Form wizard to quickly create an application in two different ways, using two different layout templates. The wizard is used to create one or more forms with user interface components called form objects. The wizard gives quick access to a subset of all of the form objects available for creating applications with the Application Builder. In the following examples, you will learn how to add input fields, numerical outputs, graphics, and buttons. For detailed information on building applications, see the *Introduction to Application Builder* manual.

The first example shows how to create an application based on a single form, using the **Single form** template. The **Single form** template makes it easy to interactively move buttons and edit fields by dragging. However, it does not allow you to resize the graphics when changing the size of the application window. The second example demonstrates how to use the **Basic** template to create an application with several forms, subwindows, and a ribbon. Using this template automatically creates an application with a resizable graphics window.

### CREATING AN APPLICATION USING A NEW SINGLE FORM

- | This example uses the busbar model. You can open the busbar file from the Application Libraries under **COMSOL Multiphysics > Multiphysics** or, if you saved your model upon completing Example 2 on page 116, you can open your saved busbar .mph file.

To switch from the Model Builder to the Application Builder, click the **Application Builder** button in the leftmost **Workspace** section of the **Home** tab on the ribbon.

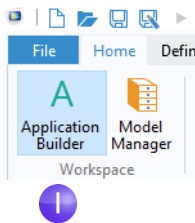

2 To create a new form, click the **New Form** button on the ribbon. This will create a new global form.

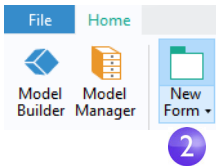

In the **Select Template** page of the wizard, select **Single form**.

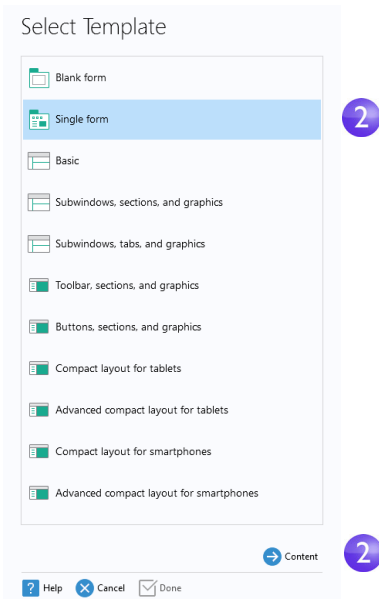

Click **Content** to continue.

The **Select Content** page appears.

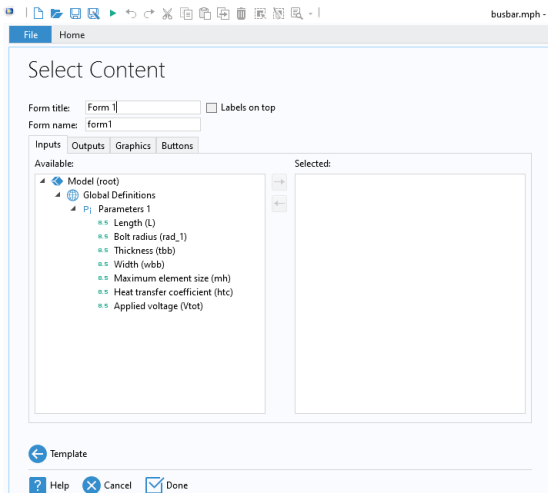

2

It consists of four tabs for **Inputs**, **Outputs**, **Graphics**, and **Buttons**. On the **Inputs** tab, you can double-click the parameters in the tree to make them available in the user interface of the application. For this application, we will select a few of the parameters as input fields and the maximum temperature as the output.

- 3 On the **Inputs** page, double-click each of the parameters: **Length (L)**, **Width (wbb)**, and **Applied voltage (Vtot)**. Also, on the **Outputs** tab double-click **Volume Maximum** under **Derived Values**.

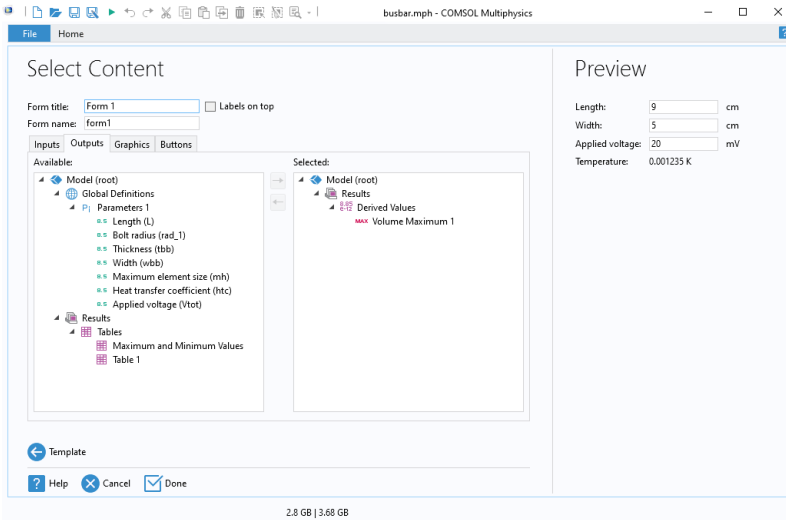

The **Preview** section to the right displays the user interface layout.

- 4 Click the **Graphics** tab in the wizard and double-click the **Temperature** plot. A graphics object placeholder appears in the **Preview** area.

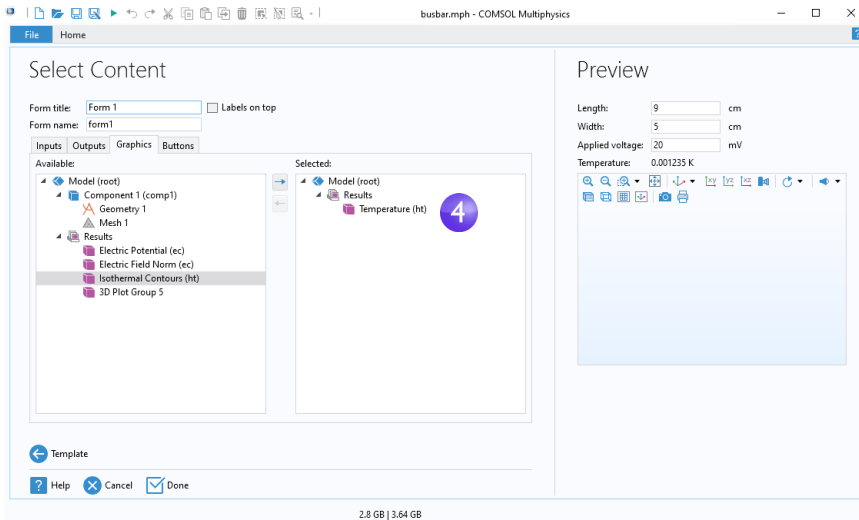



- 5 Click the **Buttons** tab in the wizard and double-click **Compute Study**. A **Compute** button now appears in the **Preview** area beneath the graphics object.

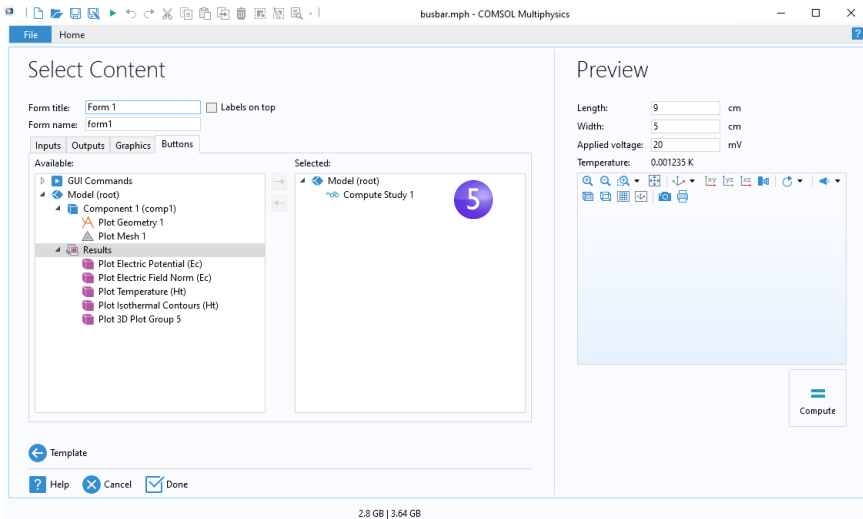

- 6 Finally, click **Done** to accept the settings and close the wizard.

After closing the Form wizard, the Form Editor is opened in the Application Builder workspace. The Form Editor allows you to drag and drop form objects and add new form objects. The default view is a preview of the form. Double-click **form1** to enable editing.

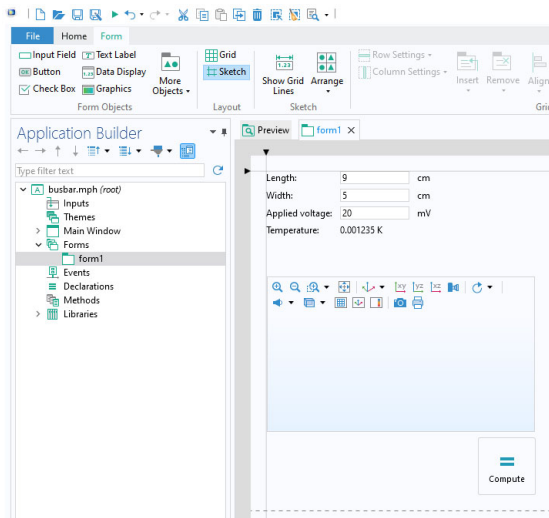

- 7 You can rearrange the user interface by dragging the graphics object to the right of the input fields and dragging the button to a position directly under the input fields, as shown in the figure below. Blue guidelines will aid you in aligning the objects.

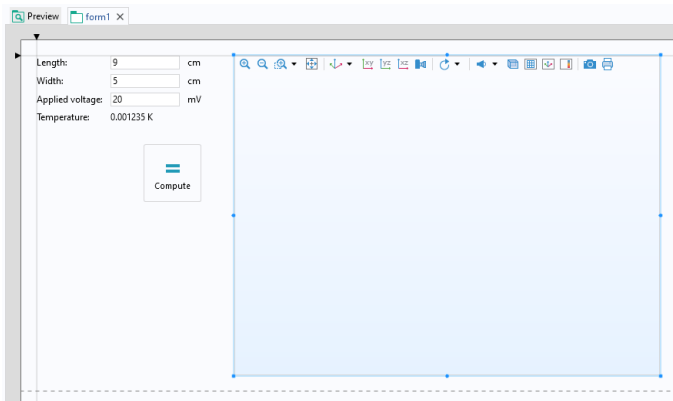

You can make the graphics object larger or smaller by dragging the blue handles.

8 You can test the application by clicking **Test Application** on the ribbon.

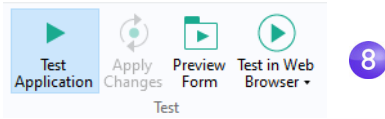

Alternatively, you can click the corresponding button in the Quick Access Toolbar. This creates a run-time copy of the application and lets you quickly try different designs during the process of developing an application.

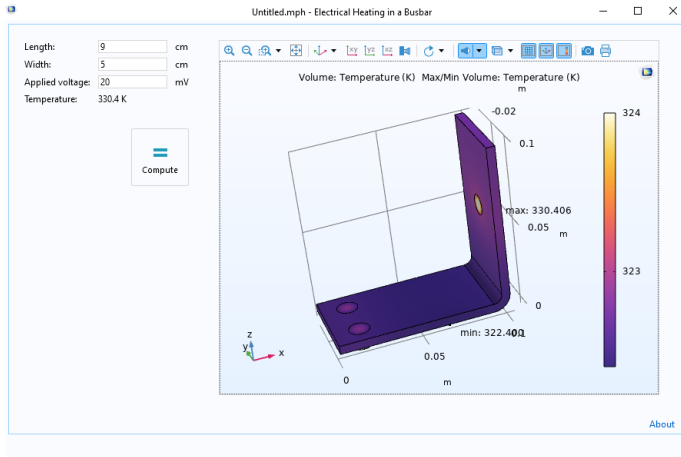

9 Now, try a different **Length** value, for example, and click **Compute**.

## ADDING A BUTTON

You may wish to preview the geometry before starting the computation. This can easily be done by adding a button. There are two ways to add a button. Either click **Button** button in the **Form Objects** section of the **Form** tab on the ribbon, as shown in the figure below, or use the **Editor Tools** window. In this example, you will use the latter method.

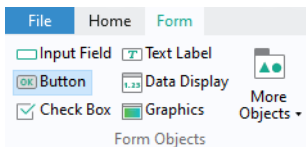

- 1 First, make sure the **Editor Tools** window is visible by selecting the corresponding button on the **Home** tab of the ribbon.

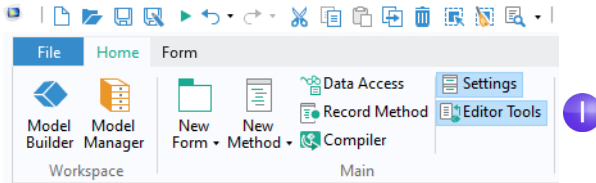

- 2 In the **Editor Tools** tree, right-click the **Geometry** node and select **Button**.

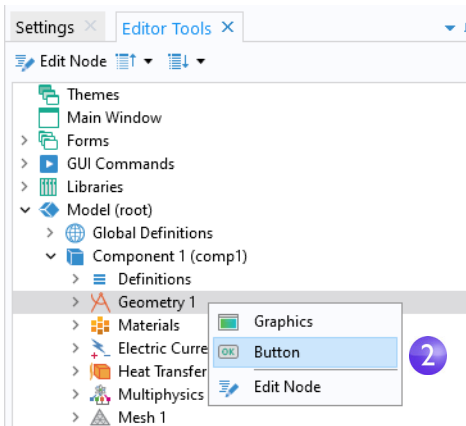

- 3 Drag the **Geometry** button to the left of the **Compute** button.

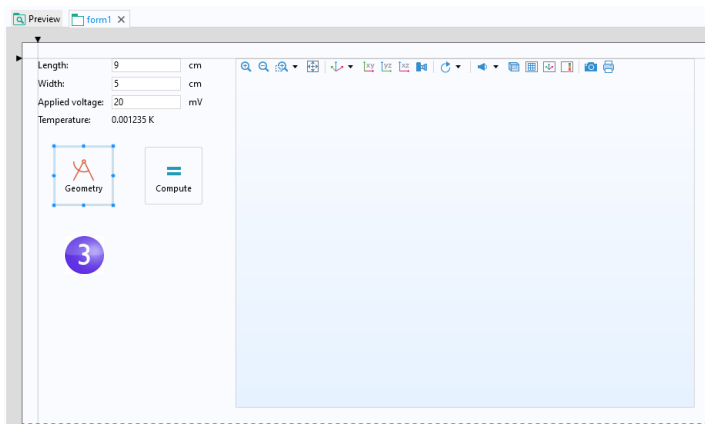

For each button, there is a command sequence that controls the action taken when it is pressed. The command sequence is defined in the **Settings** window of

the button. You can open the **Settings** window (if not already opened) by double-clicking a button.

- 4 Double-click the **Geometry** button to see its **Settings** window. Command sequences appear below the tree in the **Choose Commands to Run** section.

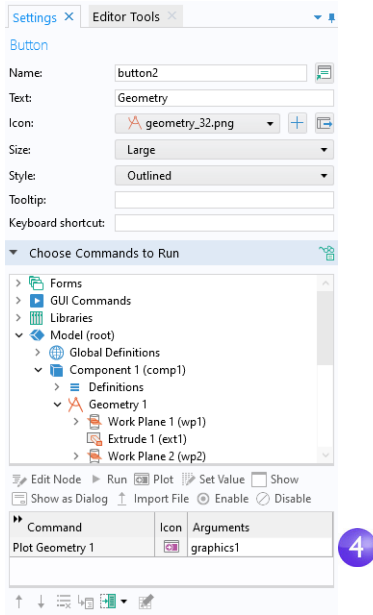

In this case, the command sequence for the **Geometry** has one command for plotting the geometry. The input argument contains information concerning which graphics window to send the geometry plot to. In this case, the graphics object is `graphics1`.

To automatically adjust the axis settings, you can add a **Zoom Extents** command.

- 5 In the **Choose Commands to Run** section, locate the **Zoom Extents** command under **GUI Commands > Graphics Commands**. Double-click to add it to the command sequence.
- 6 Now, create the input argument to the **Zoom Extents** command. Click the white field next to **Zoom extents** and click the **Edit Argument** button.

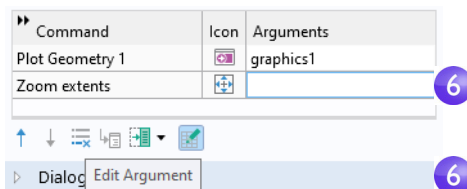

7 This opens a dialog box with possible input arguments. Select **graphics1** under **form1**.

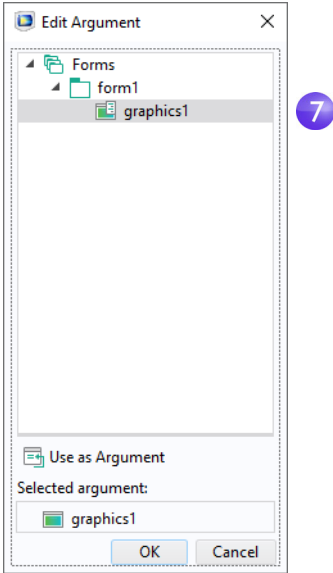

8 The command sequence is now complete.

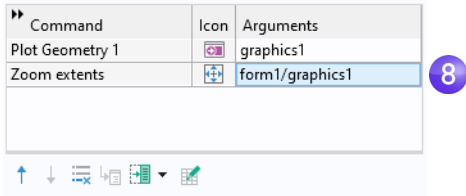

9 To make sure the new **Geometry** button works, you can test the application again by clicking **Test Application** on the ribbon.

### USING FORMS IN THE MODEL BUILDER

Forms without graphics form objects can be used in the Model Builder. You can use this functionality to create customized **Settings** windows for common or repetitive tasks, for example. If you would like to reuse your customized **Settings** window between sessions or even with other users, you can create an add-in, as explained in the *Introduction to Application Builder*.

To use a form in the Model Builder that was created with the Application Builder, right-click **Global Definitions** and select the form under **Settings Forms**.

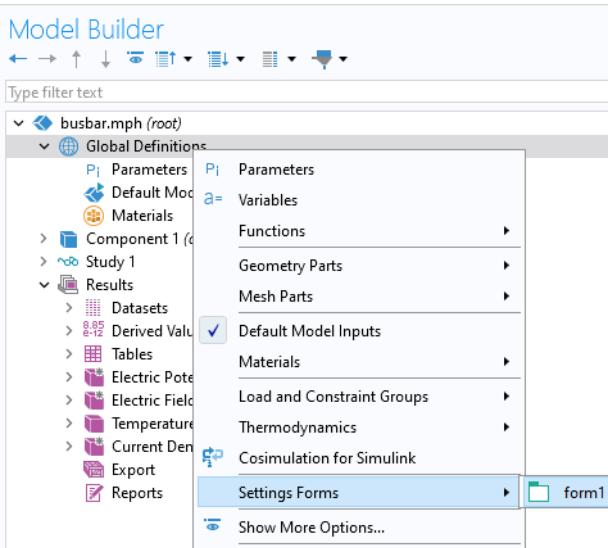

## METHODS

When you need to perform a more advanced operation than what is possible with a command sequence, you can use the Method Editor to write code that defines the actions to be taken when the user clicks a button, selects a menu item, etc. In addition to calling methods from applications or **Settings Forms**, you can call methods from the **Developer** tab on the ribbon or from **Method Calls** in the model tree. For more information, see *Introduction to Application Builder*.

An easy way to get started with the Method Editor is to convert an existing command sequence into a method.

- 1 In the Application Builder, locate or open the **Settings** window for the **Geometry** button again. Select **Convert to Method** in the menu below the command sequence. (The other two options in the drop-down list are for creating two types of local methods.)

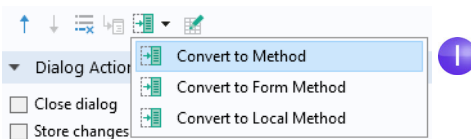

- 2 To open the method in the Method Editor, click the **Go to Method** button below the command sequence.

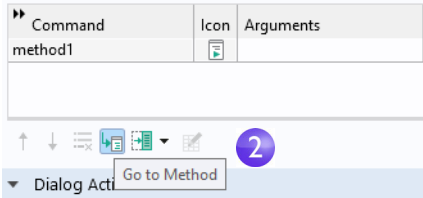

The Method Editor now opens with the code for **method1**, corresponding to the **Plot Geometry** and the **Zoom Extents** commands in the previous command sequence.

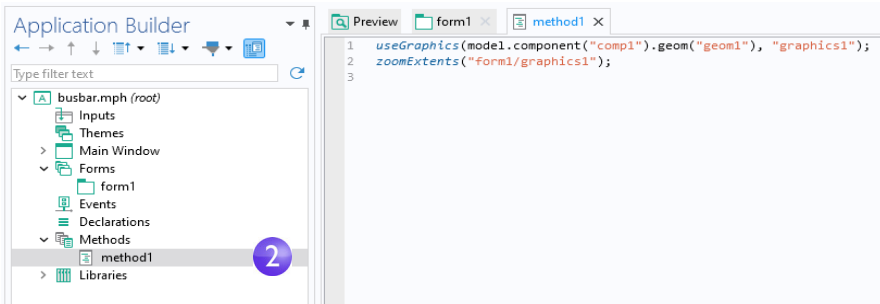

The Application Builder has several tools for automatically generating code. In addition to converting a command sequence to a method, you can, for example, click **Record Code** on the ribbon.

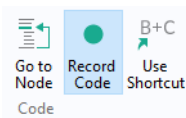

This will generate code for each operation performed in the COMSOL Desktop windows. Click **Stop Recording** on the ribbon to stop recording and go back to the Method Editor.

## CREATING AN APPLICATION USING THE BASIC TEMPLATE

This second example shows how to use the **Basic** template to create an application with several forms, subwindows, and a ribbon. Using this template creates an application with a resizable graphics window. Note that the type of applications that you create using templates can also be built using manual steps by starting



from a **Blank form** or **Single form** template; however, using templates accelerates this process. For more information, see *Introduction to Application Builder*.

This example uses the busbar model. You can open the busbar file from the Application Libraries under **COMSOL Multiphysics > Multiphysics** or, if you saved your model upon completing Example 2 on page 116, you can open your saved busbar .mph file.

- | To switch from the Model Builder to the Application Builder, click the **Application Builder** button in the leftmost **Workspace** section of the **Home** tab on the ribbon.

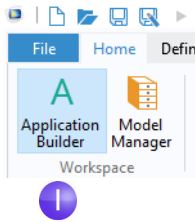

- 2 To create a new form, click the **New Form** button on the ribbon. This will create a new global form.

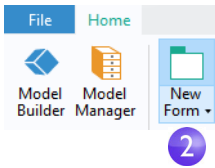

In the **Select Template** page of the wizard, select **Basic**.

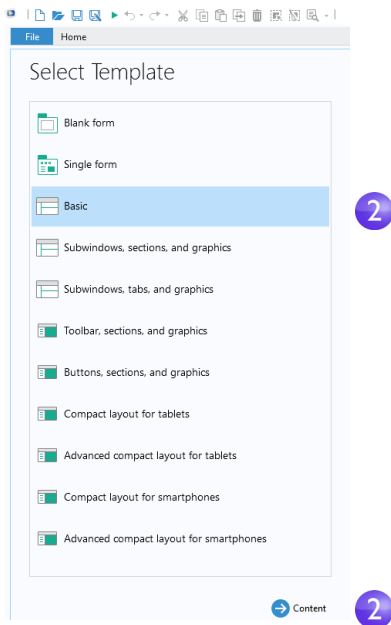

Click **Content** to continue.

The **Select Content** page appears.

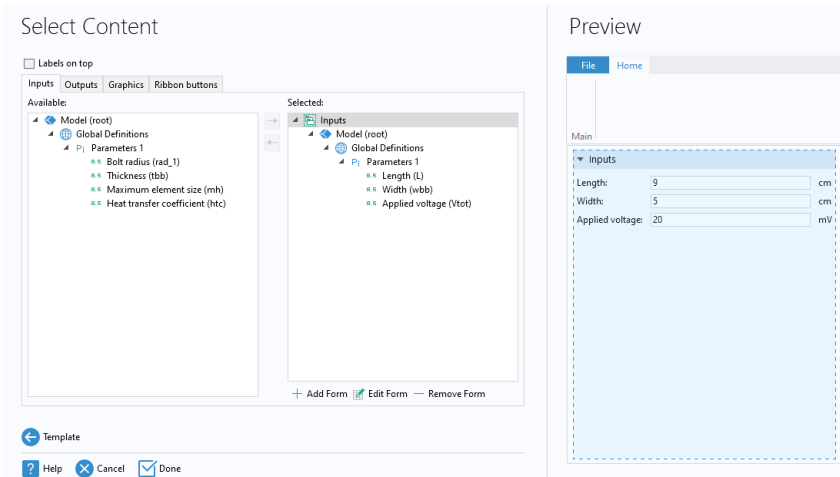

Just like when using the **Single form** template, this page consists of four tabs for **Inputs**, **Outputs**, **Graphics**, and **Ribbon buttons**. On the **Inputs** tab, you can double-click the parameters in the tree to make these available in the user interface of the application. In the same way as in the earlier example, using the **Single form** template, on the **Inputs** tab, double-click each of the parameters: **Length (L)**, **Width (wbb)**, and **Applied voltage (Vtot)**. Also, in the **Outputs** page double-click **Volume Maximum** under **Derived Values**.

- 3 Continue by clicking the **Graphics** tab in the wizard and double-click the **Temperature** plot. A graphics object placeholder appears in the **Preview** area.

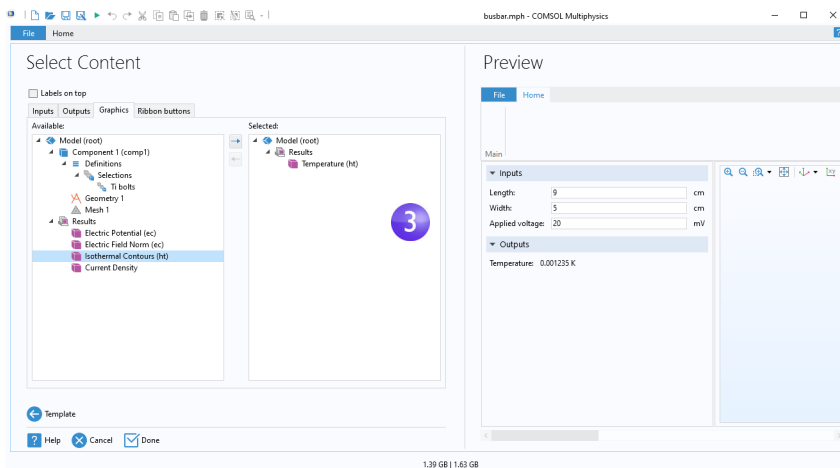

When using the **Basic** layout template, this selection determines the default plot shown when the application is started.

4 The **Ribbon buttons** tab displays the model and application tree nodes that can be run by clicking a button on the ribbon in the application user interface.

In the figure below, buttons have been added corresponding to the actions: **Plot Geometry**, **Plot Mesh**, **Compute Study**, **Plot Electric Potential**, **Plot Temperature**, **Plot Current Density**, and **Reset Window Layout**.

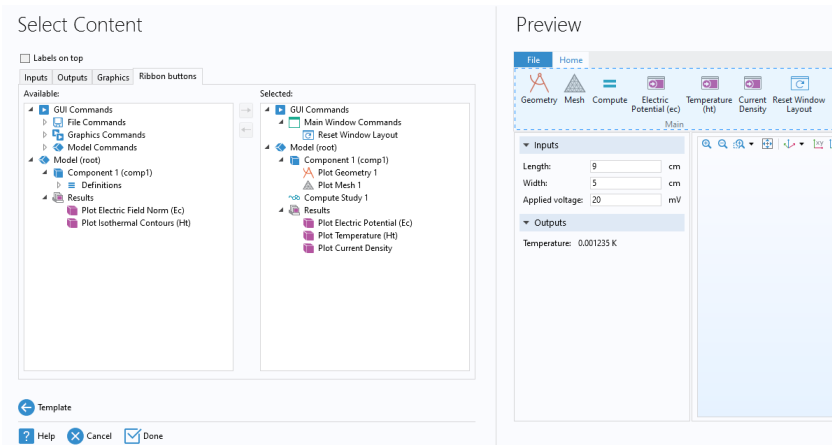

The option **Reset Window Layout** is available under **GUI Commands > Main Window Commands > Reset Window Layout**. The application consists of two subwindows, one for the inputs and outputs and one for the graphics. The **Reset Window Layout** button will reset the two resizable subwindows in the application to their original size. The **Subwindows** template is similar to the **Basic** template but additionally allows you to detach, move around, and dock the subwindows. In this case, the **Reset Window Layout** operation will rearrange all subwindows to their original position and size.

Using the Main Window Editor in the Application Builder, you can add ribbon buttons that run your own custom command sequences or methods.

Click **Done** to exit the wizard. This automatically takes you to the Main Window Editor.

5 You can test the application by clicking **Test Application** on the ribbon.

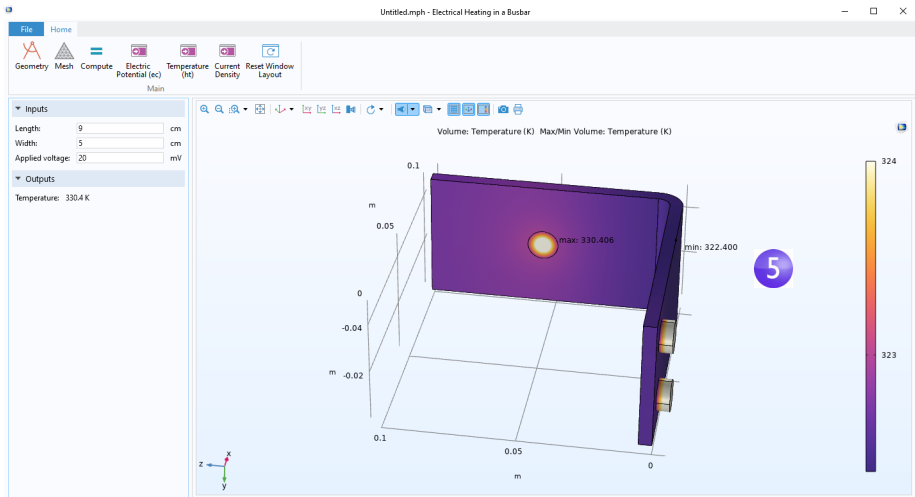

To learn more about using the Form Editor and the Method Editor, see the book *Introduction to Application Builder*, which provides more information on writing methods. For more in-depth information on methods, see the *Application Programming Guide* and the *Application Builder Reference Manual*.

This completes the busbar example. To switch back to the Model Builder, click the **Model Builder** button on the ribbon.

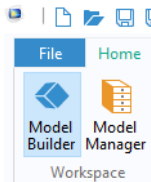

## Overview of Advanced Topics

---

The next sections are designed to deepen your understanding of the steps implemented so far and to extend your simulation to include additional effects like thermal expansion and fluid flow. These additional topics begin on the following pages:

- “Parameters, Functions, Variables, and Couplings” on page 136
- “Material Properties and Material Libraries” on page 141
- “Adding Meshes” on page 143
- “Adding Physics” on page 146
- “Parametric Sweeps” on page 169
- “Parallel Computing” on page 181
- “COMSOL Multiphysics Client–Server” on page 185
- “Appendix A — Building a Geometry” on page 214



## Parameters, Functions, Variables, and Couplings

---

This section explores working with parameters, functions, variables, and nonlocal couplings.

The **Global Definitions** and **Component > Definitions** nodes contain functionality that helps you to prepare model inputs and nonlocal couplings and to organize simulations. You have already used the functionality for adding parameters to organize model inputs in “Global Definitions” on page 81.



Functions, available as both **Global Definitions** and **Component > Definitions**, contain a set of predefined function templates that can be useful when setting up multiphysics simulations. For example, the **Step** function template can create a smooth step function for defining different types of spatial or temporal transitions.

To illustrate using functions, assume that you want to add a time-dependent study to the busbar model, where an electric potential is applied across the busbar that goes from 0 V to 20 mV in 0.5 seconds. For this purpose, you could use a step function to be multiplied with the parameter  $V_{tot}$ . In this section, you will add a step function to the model that goes smoothly from 0 to 1 in 0.5 seconds to find out how functions can be defined and verified.

### DEFINING FUNCTIONS

For this section, you can continue working with the same model file created in the previous section. Locate and open the file `busbar.mph` from page 116 if it is not already open on the desktop.



1 Right-click the **Global Definitions** node  and select **Functions > Step** .

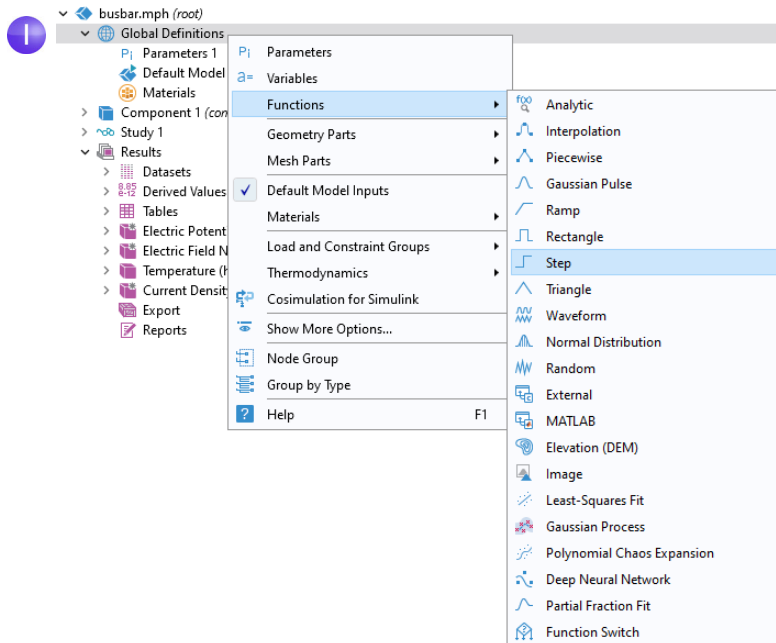

2 In the **Settings** window for **Step**, enter 0.25 in the **Location** field to set the location of the middle of the step function, where it has the value of 0.5.

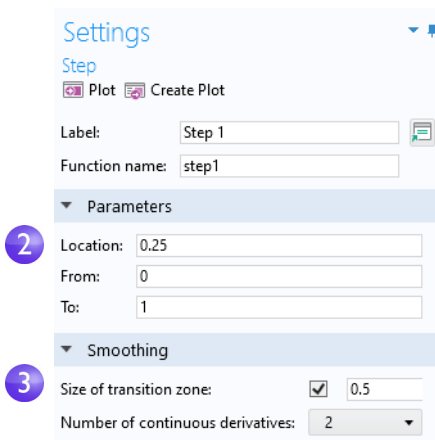

3 Click **Smoothing** to expand the section and enter 0.5 in the **Size of transition zone** field to set the width of the smoothing interval. Keep the default **Number of continuous derivatives** at 2.

4 Click the **Plot** button  in the **Settings** window for **Step**.

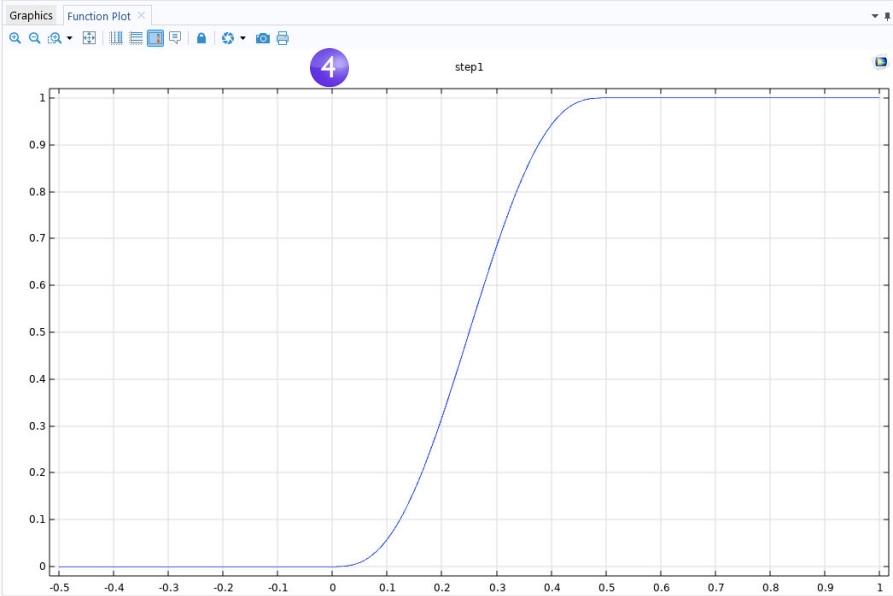

If your plot matches the one below, this confirms that you have defined the function correctly.

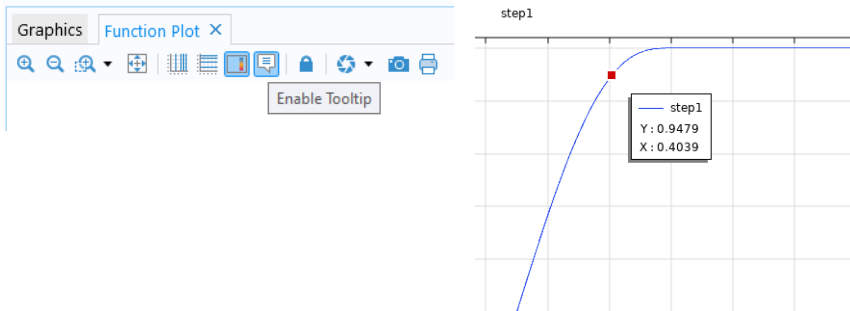

 You can enable an interactive tooltip that displays data values while hovering over the graph. To enable this, click the **Enable Tooltip** button in the **Graphics** toolbar.



You can also add comments to the function to make it more descriptive.

5 Right-click the **Step 1** node  in the **Model Builder** window and select **Properties** .

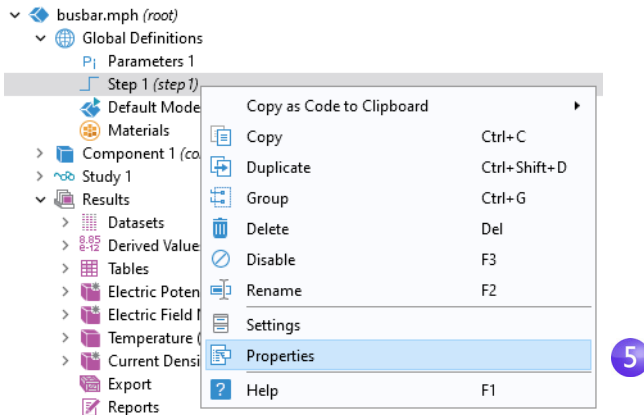

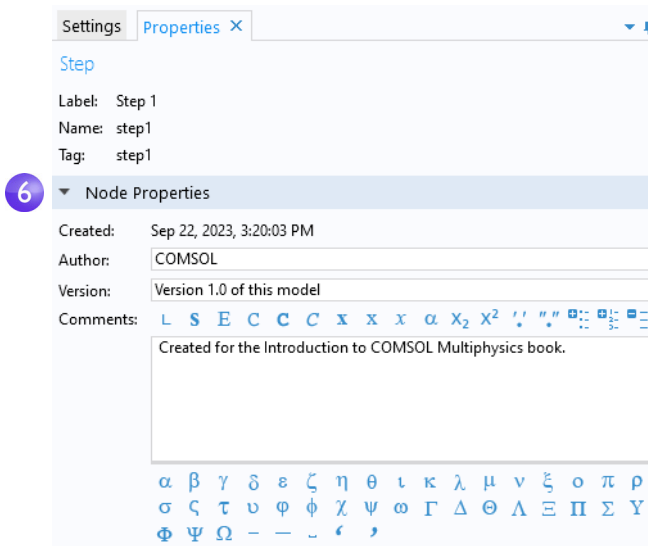

6 In the **Properties** window, enter any information you want. Right-click the **Properties** tab and select **Close** when you are finished. Special characters and markup tags that you use here will be displayed in reports generated from the **Reports** node.



For the purpose of this exercise, assume that you want to introduce additional components, for example, a second component to represent an electric device connected to the busbar through the titanium bolts.

In this case, it is good practice to give each component a descriptive name. Now, rename **Component 1** to specify that it represents the busbar.

- 1 Right-click the **Component 1** node  and select **Rename**  (or press F2).
- 2 In the **Rename Component** window, enter Busbar. Click **OK** and save the model.

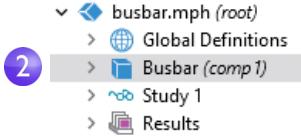



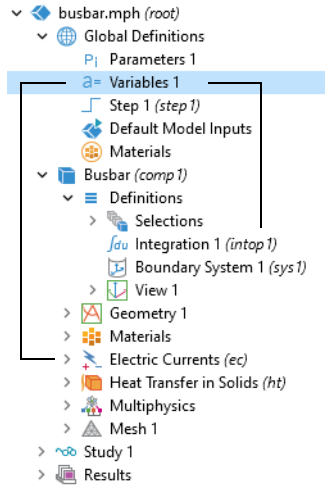

### DEFINING NONLOCAL COUPLINGS AND PROBES

Right-click the **Definitions** node  under **Busbar (comp 1)** to introduce a nonlocal coupling that computes the integral of any **Busbar (comp 1)** variable at the bolt boundaries facing the electric device. You can use such a coupling to define a variable in a **Variables** node under the **Global Definitions** node that calculates the total current. This variable is then globally accessible and could, for example, form a boundary condition for the current that is fed to an electric device modeled as a second component.

The **Nonlocal Couplings** in **Definitions** have a wide range of uses. The **Average** <sub>AV</sub>, **Maximum** <sub>MAX</sub>, and **Minimum** <sub>MIN</sub> couplings have applications in generating results as well as in boundary conditions, sources, sinks, properties, or any other contribution to the model equations. The **Probes**  are for monitoring the solution progress. For instance, you can follow the solution at a critical point during a time-dependent simulation or for each parameter value in a parametric study.



You can find an example of using the average operator in “Parametric Sweeps” on page 169. Also see “Functions” on page 245 for a list of available functions.

 To learn more about working with definitions, in the **Model Builder** window, click the **Definitions**  or **Global Definitions**  node and press F1 to open the **Help** window . This window displays helpful information about the selected item in the desktop and provides links to the documentation. It could take up to a minute for the window to load the first time it is activated, but will load quickly the next time it is opened.

## Material Properties and Material Libraries

You have already used the functionality in the **Materials** node to access the properties of copper and titanium in the busbar model. In the **Materials** node, you are also able to define your own materials and save them in your material library. In addition, you can add material properties to existing materials. In cases where you define properties that are functions of other variables, typically temperature, the plot functionality helps you to verify the property functions in the range of interest. You can also load Excel<sup>®</sup> spreadsheets and define interpolation functions for material properties using LiveLink<sup>™</sup> for Excel<sup>®</sup>.

The Material Library add-on product contains over 15000 materials with hundreds of thousands of material properties. In addition, many of the add-on products include material libraries relevant to their application areas.

First, investigate how to add properties to an existing material. Assume that you want to add bulk modulus and shear modulus to the copper properties.

### CUSTOMIZING MATERIALS

Let us keep working on the busbar.

- 1 In the **Model Builder** window, under **Materials**, click **Copper** .

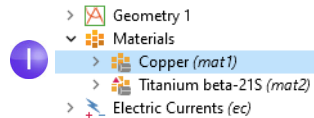

- 2 In the **Settings** window for **Material**, click to expand the **Material Properties** section, which contains a list of all of the definable properties.

Expand the **Solid Mechanics > Linear Elastic Material** section. Right-click **Bulk Modulus and Shear Modulus** and select **+ Add to Material**.

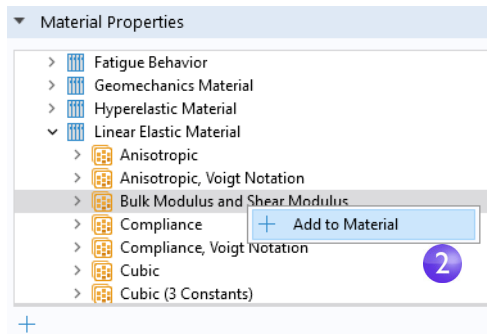

This lets you define the bulk modulus and shear modulus for the copper in your model.

- 3 In the **Copper** node, locate the **Material Contents** section. **Bulk modulus** and **Shear modulus** rows are now available in the table. The warning sign  indicates that

the values are not yet defined. To define the values, click the **Value** column. In the **Bulk modulus** row, enter 140e9 and in the **Shear modulus** row, enter 46e9.

3

Material Contents					
Property	Variable	Value	Unit	Property group	
Bulk modulus	K	140e9	N/m <sup>2</sup>	Bulk modulus and shear...	
Shear modulus	G	46e9	N/m <sup>2</sup>	Bulk modulus and shear...	
Electrical conductivity	sigma...	5.998e7[...	S/m	Basic	
Heat capacity at constant pres...	Cp	385[J/(k...	J/(kg·K)	Basic	
Relative permittivity	epsilo...	1	1	Basic	
Density	rho	8960[kg...	kg/m <sup>3</sup>	Basic	
Thermal conductivity	k_iso ;...	400[W/(...	W/(m...	Basic	
Relative permeability	mur_is...	1	1	Basic	
Coefficient of thermal expansi...	alpha_...	17e-6[1/...	1/K	Basic	
Young's modulus	E	110[GPa]	Pa	Young's modulus and P...	
Poisson's ratio	nu	0.35	1	Young's modulus and P...	

By adding these material properties, you have changed the contents of the **Copper** material. You can save this information in your own material library, but not in the read-only Solid Mechanics materials library.

4 In the **Model Builder** window, right-click **Copper** and select **Add to User-Defined Library**.

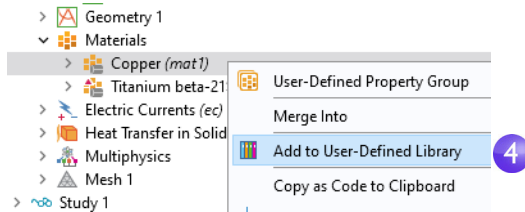



To see this library, click the **Browse Materials** in the **Materials** tab on the ribbon.

## Adding Meshes

A model component can contain different mesh sequences for generating meshes with different settings. A mesh sequence is an ordered set of instructions for generating a mesh. Mesh sequences can be accessed by the study steps. In a study, you can select which mesh you would like to use in a particular simulation.

In the busbar model, a second mesh node is now added to create a mesh that is a bit coarser (has larger elements).

### ADDING A MESH

- 1 Open the model busbar.mph that was saved earlier on page 116.
- 2 In order to keep this model in a separate file for later use, select **File > Save As** and rename the model busbar\_I.mph.
- 3 To add a second mesh node, right-click the **Component 1** node  and select **Add Mesh** . (If you followed the instructions in “Parameters, Functions, Variables, and Couplings” on page 136, the name of **Component 1** is **Busbar** instead.)

By adding another **Mesh** node, a **Mesher** parent node is created that contains both **Mesh 1** and **Mesh 2**.

- 4 Click the **Mesh 2** node. In the **Settings** window for **Mesh** under **Mesh Settings**, select **User-controlled mesh** as the **Sequence type**. A **Size** and **Free Tetrahedral** node are now available under **Mesh 2**.

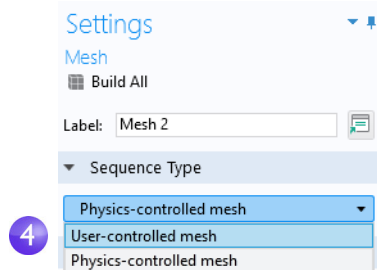
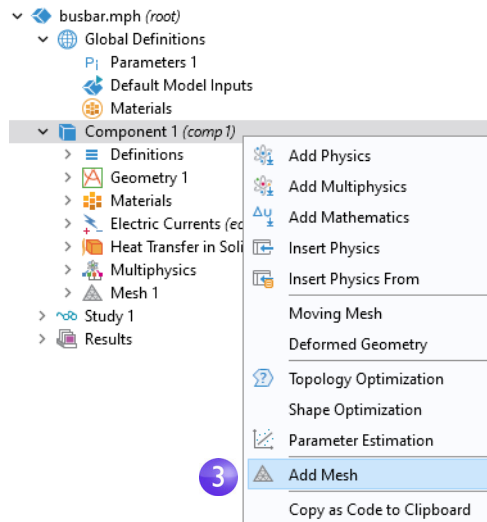

5 In the **Model Builder** window, under **Mesh 2**, click **Size** .

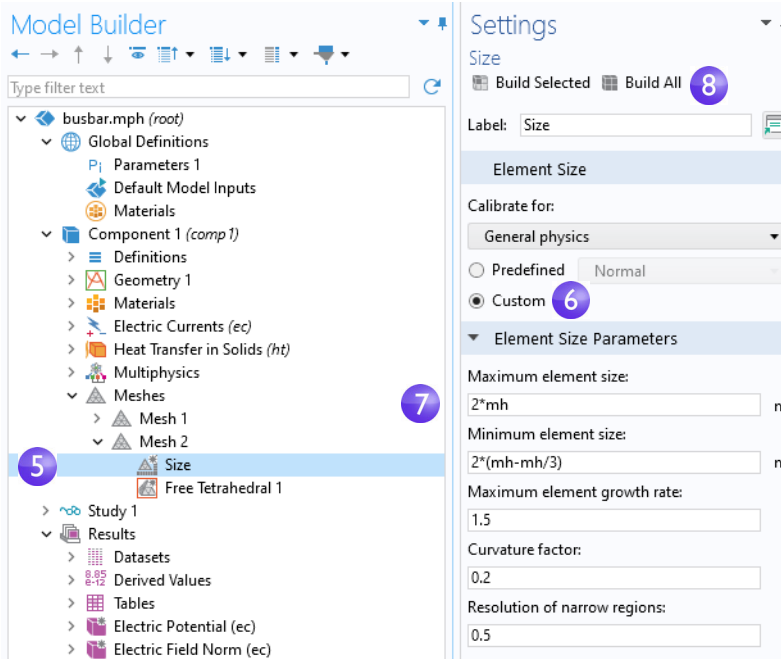

The asterisk in the upper-right corner of a node icon indicates that the node is being edited.

6 In the **Settings** window for **Size**, under **Element Size**, click the **Custom** button.

7 Under **Element Size Parameters**, enter:

- $2*mh$  in the **Maximum element size** field, where  $mh$  is 3 mm — the mesh control parameter defined previously.
- $2*(mh-mh/3)$  in the **Minimum element size** field.
- 0.2 in the **Curvature factor** field.

8 Click **Build All** . Save the file as `busbar_I.mph`.

Compare **Mesh 1** and **Mesh 2** by clicking the **Mesh** nodes. The mesh is updated in the **Graphics** window. An alternative to creating multiple meshes in this way is to



run a parametric sweep of the parameter for the maximum mesh size,  $m_h$ , that was defined in the section “Global Definitions” on page 81.

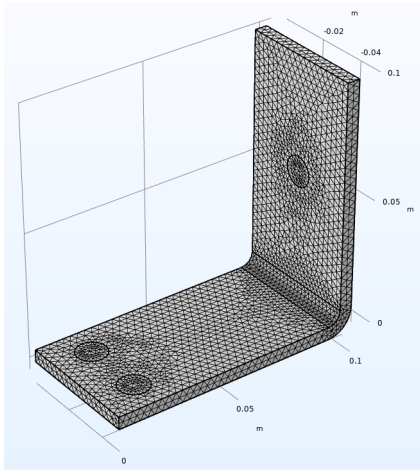

Mesh 1

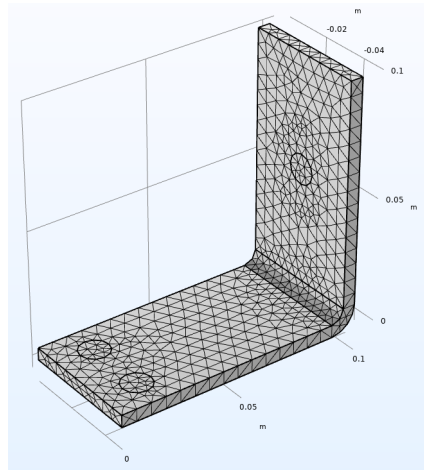

Mesh 2

## Adding Physics

---

The distinguishing characteristics of COMSOL Multiphysics, particularly adaptability and compatibility, are prominently displayed when you add physics to an existing model.



In this section, you will experience the ease with which this seemingly difficult task is performed. By following these directions, you can add structural mechanics and fluid flow to the busbar model.

### STRUCTURAL MECHANICS

After completing the busbar Joule heating simulation, we know that there is a temperature rise in the busbar. What kind of mechanical stress is induced by thermal expansion? To answer this question, let us expand the model to include the physics associated with structural mechanics.

 To complete these steps, either the Structural Mechanics Module or the MEMS Module (which enhances the core Solid Mechanics interface) is required.

If you want to add cooling by fluid flow, or do not have the Structural Mechanics Module or MEMS Module, read this section and then go to “Cooling by Adding Fluid Flow” on page 155.

- 1 Open the model busbar.mph that was saved earlier on page 116. From the main menu, select **File > Save As** and rename the model busbar\_II.mph. Alternatively, you could load the busbar.mph model from the Application Libraries as shown earlier.
- 2 In the **Model Builder** window, right-click the **Component 1** node  and select **Add Physics** .

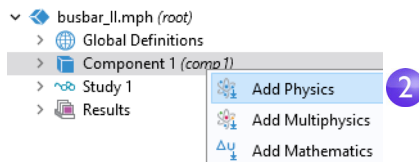

- 3 In the **Add Physics** window, under **Structural Mechanics**, select **Solid Mechanics**.

To add this interface, you can right-click and select **Add to Component 1** or click the **+ Add to Component 1** button at the top of the window. You can also double-click.

- 4 Close the **Add Physics** window and save the file.

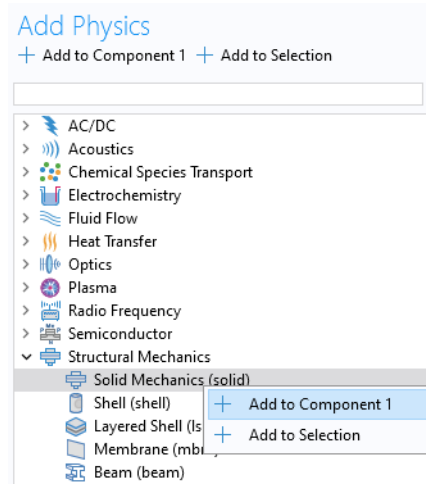

When adding additional physics, you need to make sure that materials included in the **Materials** node have all of the required properties for the selected physics. In this example, all properties are already available for copper and titanium.

You can start by adding the effect of thermal expansion to the structural analysis.

- 5 In the **Model Builder** window, right-click the **Multiphysics** node and select **Thermal Expansion**.

A **Thermal Expansion** node is added to the model tree.

You can also use the ribbon and, from the **Physics** tab, select **Multiphysics Couplings > Thermal Expansion**.

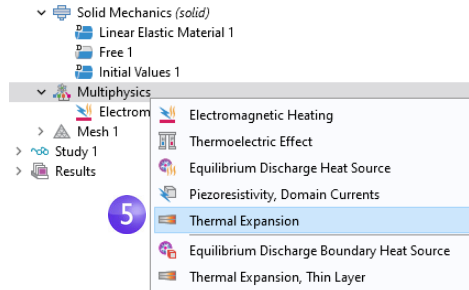

6 In the **Settings** window for **Thermal Expansion**, select **All domains** from the **Selection** list. This will enable thermal expansion in the copper as well as in the titanium bolts.

The **Thermal Expansion Properties** section of this window shows information about the coefficient of thermal expansion and the strain reference temperature (there are also some more advanced settings). The **Coefficient of thermal expansion** takes its value from the **Materials** node. In the **Model Input** section, the **Volume reference temperature** (strain reference temperature) has a default value of 293.15 K (room temperature) taken from **Common model input**, which in this case corresponds to the **Default Model Inputs** node that is available in **Global Definitions**, and defines the temperature for which there is no thermal expansion. The **Coupled Interfaces** section shows which two physics interfaces define the physics for heat transfer and solid mechanics. This is useful in the case where there is more than one physics interface for heat transfer or solid mechanics in the model component. Keep all default settings in this window.

Next, constrain the busbar at the position of the titanium bolts.

7 In the model tree, right-click **Solid Mechanics** and from the boundary level, select **Fixed Constraint**. A node with the same name is added to the tree.

8 Click the **Fixed Constraint** node. In the **Graphics** window, rotate the busbar to view the back. Click the circular surface of one of the bolts to add it to the **Selection** list.

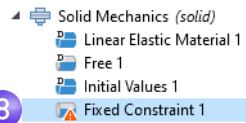
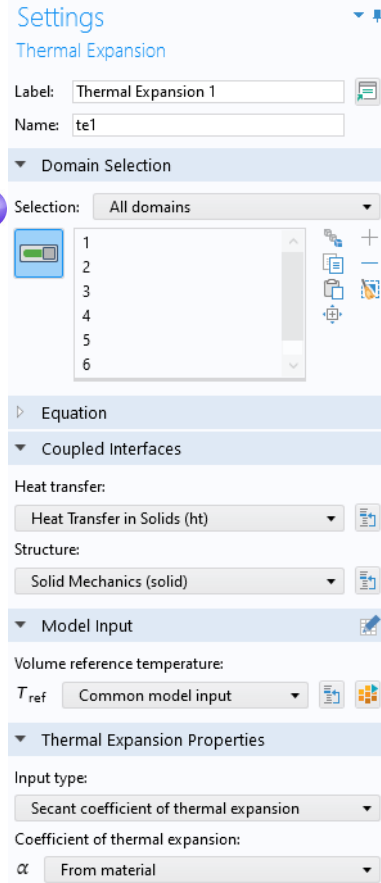

9 Repeat this procedure for the remaining bolts to add boundaries 8, 15, and 43.

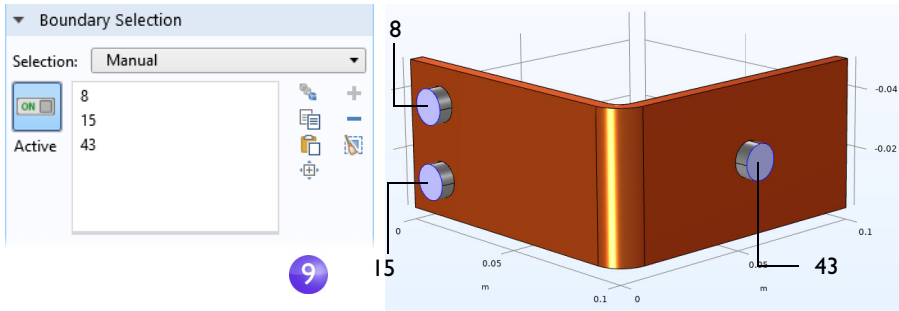

For easier management of multiple boundary selections, you can group boundaries into a user-defined selection. Once you have selected boundaries 8, 15, and 43, click the **Create Selection** button and give it a name, such as **Bolt top surfaces**.

This selection is then added as a node under **Component 1 > Definitions** and is accessible from the **Selection** list in the **Settings** window for all types of boundary conditions. You can use this technique to group domains, boundaries, edges, and points. In the figure below, an additional selection for the titanium bolt domains has been created.

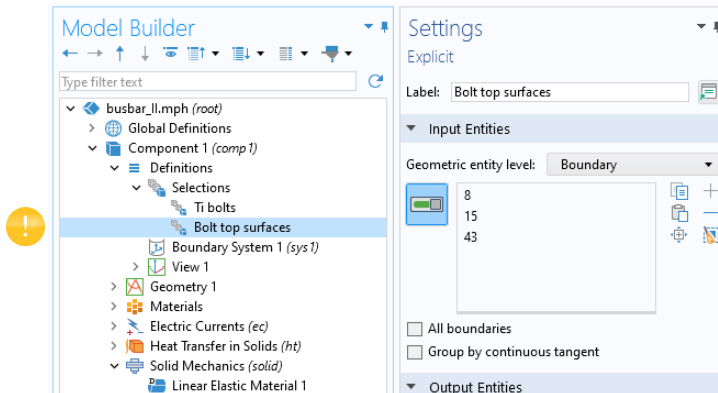

Next, we update the **Study** node to take the added physics into account.

## SOLVING FOR JOULE HEATING AND THERMAL EXPANSION

The Joule heating effect is independent of the stresses and strains in the busbar, assuming temperature invariant materials and small deformations, and ignoring the effects of electric contact pressure. This means that you can run the simulation using the temperature as merely an input to the structural analysis. In other words, the extended multiphysics problem is weakly coupled. As such, you can solve it in

two separate study steps to save computation time — one for Joule heating and a second one for structural analysis. In a more advanced analysis, you can include all of the aforementioned effects.



For this example, you can skip these steps and just click **Compute**.

However, the following technique can be useful for saving computational time and memory resources, especially for larger simulations.

- In the **Model Builder** window, right-click **Study 1** and select **Study Steps > Stationary > Stationary** to add a second stationary study step.

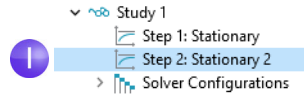

When adding study steps, you need to manually connect the respective physics with the correct study step. We start by disabling the structural analysis from the first step.

- Under **Study 1**, click the **Step 1: Stationary** node.

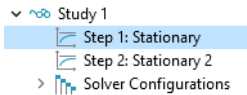

- In the **Settings** window for **Stationary**, locate the **Physics and Variables Selection**.

- In the **Solid Mechanics (solid)** row under **Solve for**, click to change the check mark  to an  to remove **Solid Mechanics** from **Study Step 1**.

In the **Multiphysics couplings** section, keep all of the default settings.

Physics and Variables Selection			
<input type="checkbox"/> Modify model configuration for study step			
»	Physics interface	Solve for	Equation form
<input checked="" type="checkbox"/>	Electric Currents (ec)	<input checked="" type="checkbox"/>	Automatic (Stationary)
<input checked="" type="checkbox"/>	Heat Transfer in Solids (ht)	<input checked="" type="checkbox"/>	Automatic (Stationary)
<input checked="" type="checkbox"/>	Solid Mechanics (solid)	<input type="checkbox"/>	Automatic (Stationary)
»	Multiphysics couplings	Solve for	Equation form
<input checked="" type="checkbox"/>	Electromagnetic Heating 1 (emh1)	<input checked="" type="checkbox"/>	Automatic (Stationary)
<input checked="" type="checkbox"/>	Thermal Expansion 1 (te1)	<input checked="" type="checkbox"/>	Automatic (Stationary)



Now, repeat these steps to remove **Electric Currents (ec)** and **Heat Transfer in Solids (ht)** from the second study step.

- Under **Study 1**, click **Step 2: Stationary 2**.

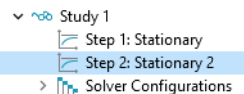







- 6 Under **Physics and Variables Selection**, in the **Electric Currents (ec)** and **Heat Transfer in Solids (ht)** rows, click to change the check mark  to an  to remove Joule heating from **Step 2: Stationary 2**.

Physics and Variables Selection			
<input type="checkbox"/> Modify model configuration for study step			
▶▶ Physics interface		Solve for	Equation form
<input checked="" type="checkbox"/>	Electric Currents (ec)	<input type="checkbox"/>	Automatic (Stationary)
<input checked="" type="checkbox"/>	Heat Transfer in Solids (ht)	<input type="checkbox"/>	Automatic (Stationary)
<input checked="" type="checkbox"/>	Solid Mechanics (solid)	<input checked="" type="checkbox"/>	Automatic (Stationary)
▶▶ Multiphysics couplings		Solve for	Equation form
<input checked="" type="checkbox"/>	Electromagnetic Heating 1 (emh1)	<input checked="" type="checkbox"/>	Automatic (Stationary)
<input checked="" type="checkbox"/>	Thermal Expansion 1 (te1)	<input checked="" type="checkbox"/>	Automatic (Stationary)

6





- 7 Right-click the **Study 1** node  and select **Compute** = (or press F8 or click **Compute** on the ribbon) to solve.

Study 1		
	Step 1: Stationary	
	Step 2: Stationary 2	
	Solver Configurations	
	Results	
	Compute	F8
	Update Solution	F5
	Parametric Sweep	

Save the file as `busbar_II.mph`, which now includes the **Solid Mechanics** interface and the additional study step.

## RESULTING DEFORMATION

Now that a physics interface has been added, additional plots for **Solid Mechanics** need to be added manually. First, a displacement plot.

- 1 In the **Model Builder** window, right-click **Results**  and add a **3D Plot Group** . In the **Label** field enter `Displacement` to give the plot group a descriptive name. Right-click **Displacement**  and add a **Surface 1** node . Click the **Surface 1** node .

▶	Results
>	Datasets
>	Derived Values
>	Tables
>	Electric Potential (ec)
>	Electric Field Norm (ec)
>	Temperature (ht)
>	Current Density
▼	Displacement
	Surface 1
	Export
	Reports

1

2 In the **Settings** window for **Surface** in the **Expression** section, click the **Replace Expression** button .

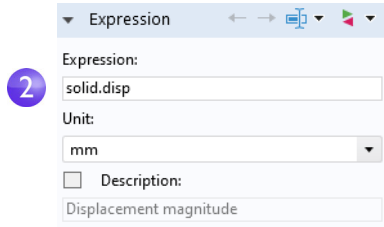



From the context menu, select **Model > Component 1 > Solid Mechanics > Displacement > solid.disp - Displacement magnitude - m**.

You can also enter `solid.disp` in the **Expression** field.

Now, change to a more suitable unit. In the **Settings** window under **Expression**, from the **Unit** list, select **mm** (or type `mm` in the field).

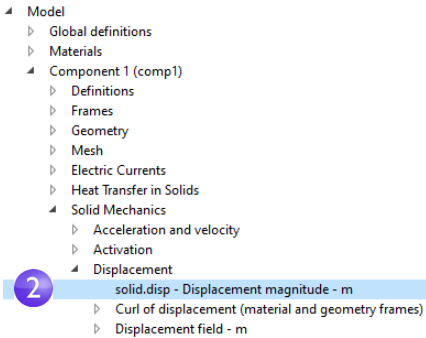

The local displacement due to thermal expansion is displayed as a surface plot.

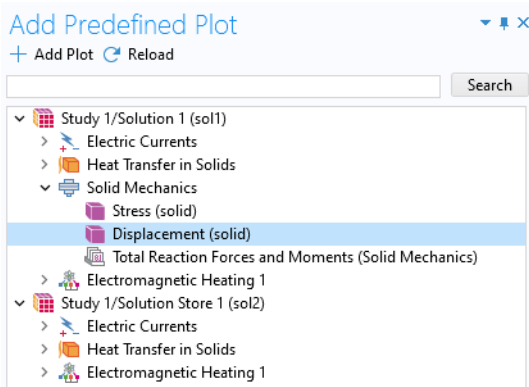

 Alternatively, you can use the **Add Predefined Plot** window to add a **Displacement** plot.



Next, we will add information about the busbar deformation.

3 In the **Model Builder** window, under **Results > Displacement**, right-click the **Surface 1** node  and add a **Deformation** node . The plot automatically updates in the **Graphics** window. Click the **Go to Default View** button  so your view appears similar to the plot shown below.



- ! The deformations shown in the figure are highly amplified to make the very small distortions that actually take place more visible.

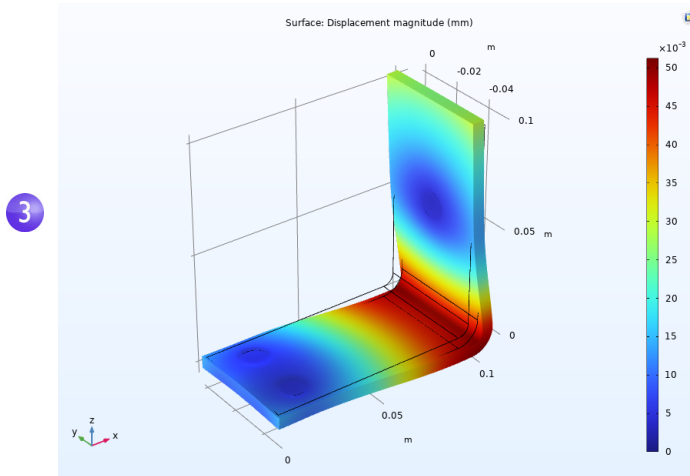

- 4 Save the busbar\_II.mph file, which now includes a **Surface** plot with a **Deformation**.

- ! You can also plot the von Mises and principal stresses to assess the structural integrity of the busbar and the bolts.

#### OVERRIDE AND CONTRIBUTION: EXCLUSIVE AND CONTRIBUTING NODES

The model tree nodes for a physics interface are traversed in a downward sequence starting from the top. Depending on the selection, a node can totally or partially override, or shadow, a node that comes earlier in the sequence. There are two types of physics interface nodes: exclusive and contributing. How the nodes are treated depends on the type.

A constraint boundary condition is a typical example of an exclusive node. Examples of constraint boundary conditions include **Electric Potential** or **Fixed Constraint**. In the case of **Electric Currents**, for example, if there are two or more **Electric Potential** nodes for the same boundary, then the last **Electric Potential** node in the sequence will override the settings of the other nodes. The **Ground** node is also an exclusive node and will similarly override the boundary conditions specified by any previous node.

The figure below shows the **Override and Contribution** section in the **Settings** window for **Electric Potential**. The **Overrides** list indicates that this boundary condition takes precedence over the default **Electric Insulation** boundary condition.

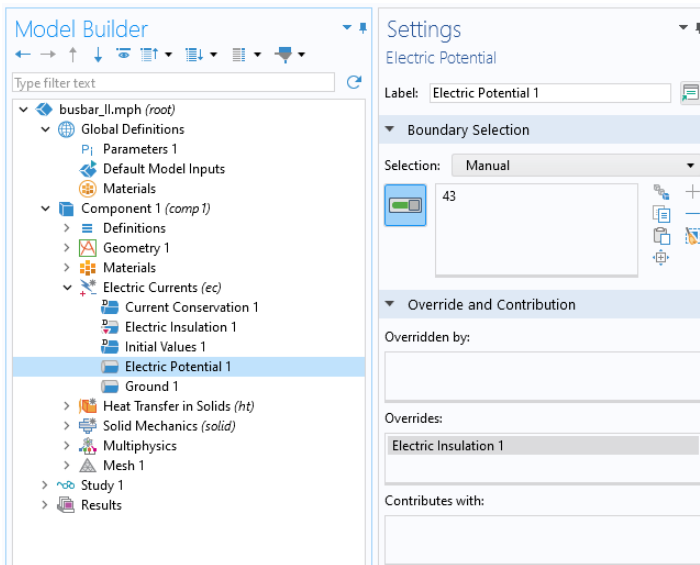

A flux boundary condition, such as one specifying a heat flux, is a typical example of a contributing node. You can stack several heat flux boundary conditions and they will all contribute to the total heat flux. The figure below shows an example where a **Heat Flux 2** boundary condition overrides the default **Thermal Insulation** boundary condition and contributes to the heat flux together with **Heat Flux 1**.

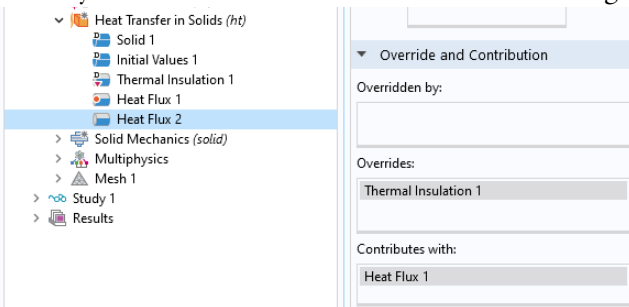

In the model tree, the override and contribution relationships are indicated by a red arrow and an orange circle, respectively.

## COOLING BY ADDING FLUID FLOW

After analyzing the heat generated in the busbar and possibly the induced thermal expansion, you might want to investigate ways of cooling the busbar by letting air flow over its surfaces. These steps do not require any additional modules, as the model only includes Joule heating without the previous thermal expansion analysis.



If you use either the **Nonisothermal Flow** or **Conjugate Heat Transfer** multiphysics interface, the coupling between heat transfer in solids and fluids is automatic, whereas in this example, this is done manually and with limited functionality. This is to illustrate adding a multiphysics coupling to an already existing analysis.

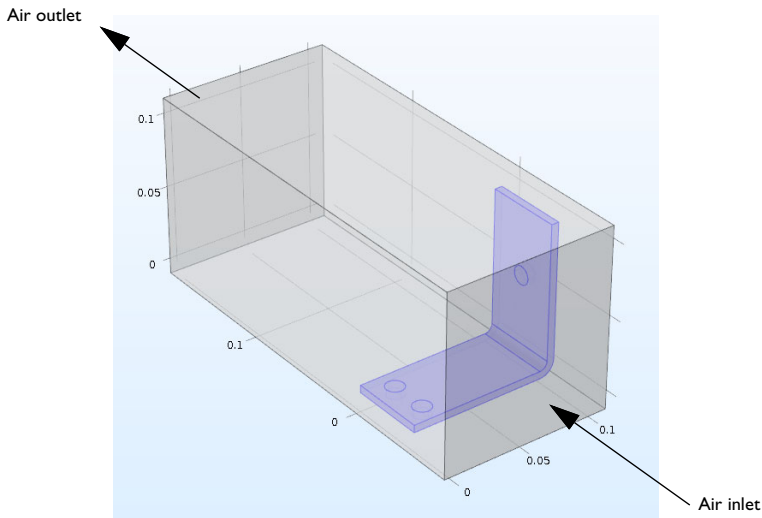

Adding fluid flow to the Joule heating model creates a new multiphysics coupling. To simulate the flow domain, you need to create an air box around the busbar for the external flow. You can do this manually by altering the geometry from your first model or by opening an Application Library file. To save time, open a file with the box already created.

After loading the geometry, as described later, you will learn how to simulate air flow according to this figure:





## DEFINING INLET VELOCITY

Start by loading the geometry and adding a new parameter for the inlet flow velocity.

- 1 If you have just reopened the software, close the **New** window that opens automatically by clicking the **Cancel** button .
- 2 Click the **Home** tab, and, from the **Windows** menu, select **Application Libraries** . Navigate to **COMSOL Multiphysics > Multiphysics > busbar box**. (You can also open the Application Libraries directly from the **File** menu.)

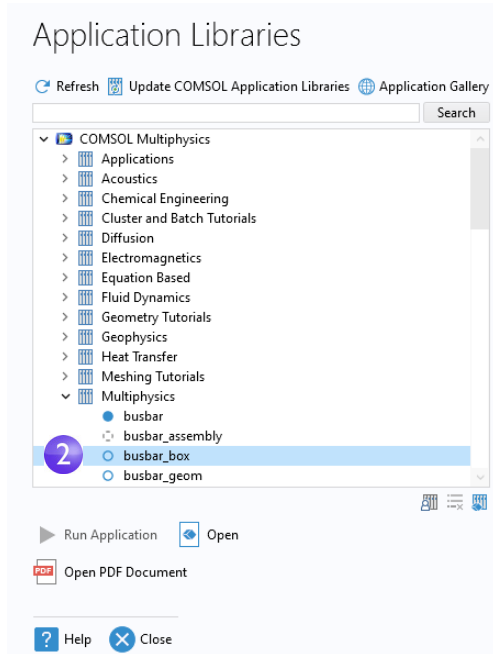
Double-click to open the file, which contains the geometry in addition to the physics modeling steps completed through the end of the section “Customizing Materials” on page 141.



- 3 Under **Global Definitions**, click the **Parameters** node .
- 4 In the **Settings** window for **Parameters**, click the empty row just below the **Vtot** row. In the **Name** column, enter  $V_{in}$ . Enter  $0.1 \text{ [m/s]}$  in the **Expression** column

and a description of your choice in the **Description** column, such as Inlet velocity.

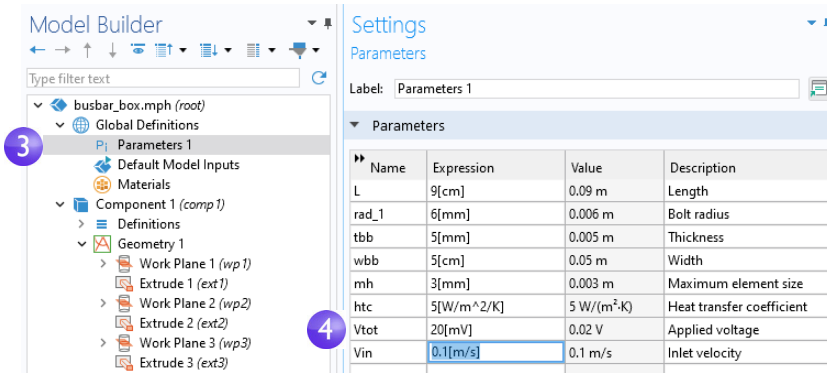



5 Select **File > Save As** and save the model with a new name, busbar\_box\_I.mph.

## ADDING AIR

The next step is to add the material properties of air.

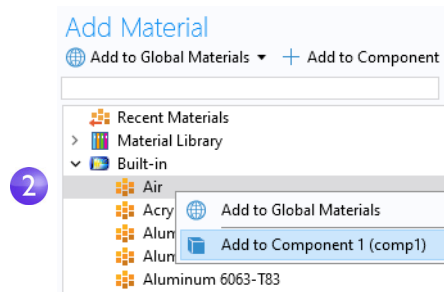
- 1 From the **Home** tab, select **Add Material**  (or right-click the **Materials** node and select **Add Material from Library**).
- 2 In the **Add Material** window, expand the **Built-In** node. Right-click **Air** and select **Add to Component I**. Close the **Add Material** window.



3 In the **Model Builder** window, under **Materials**, click the **Air** node .

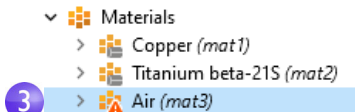

4 On the **Graphics** window toolbar, click **Zoom Extents** .

- In the **Graphics** window, click the air box (domain 1) to add it to the **Selection** list, which changes the color to blue. This step assigns the air material properties to the air box.

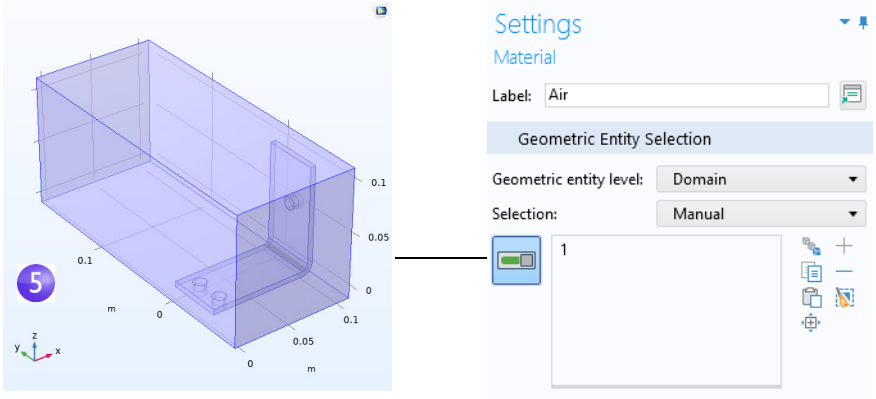

## ADDING FLUID FLOW

Now, add the physics of fluid flow.

- In the model tree, right-click **Component 1** and select **Add Physics**.
- In the **Add Physics** window under **Fluid Flow > Single-Phase Flow**, right-click **Laminar Flow** and select **+ Add to Component**. **Laminar Flow** will appear under **Component 1** in the model tree. Close the **Add Physics** window.

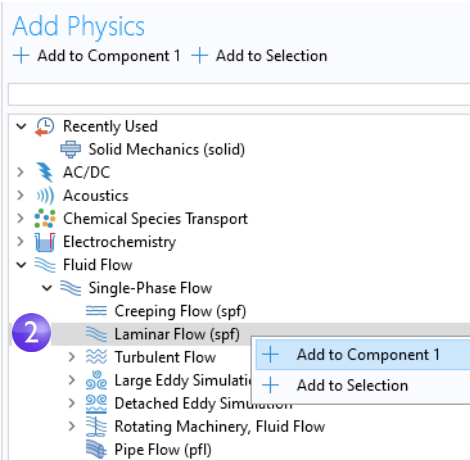



- In the **Graphics** toolbar, click the **Transparency** button. In addition, click the **Wireframe Rendering** button. These two settings make it easier to see inside the box. Toggle these on and off as needed during the modeling process to control the type of rendering used.

Now that you have added fluid flow to the model, you need to remove the air domain (domain 1) from the **Electric Currents (ec)** interface (assuming that the air has no electric conductivity and hence no currents) and then couple the heat transfer part of the **Joule Heating** multiphysics interface to the fluid flow.

- 4 In the model tree, select the **Electric Currents (ec)** node . In the **Graphics** window, move the mouse pointer over the air domain and click to remove it from the selection list. At this point, only the busbar should be selected and highlighted in blue.

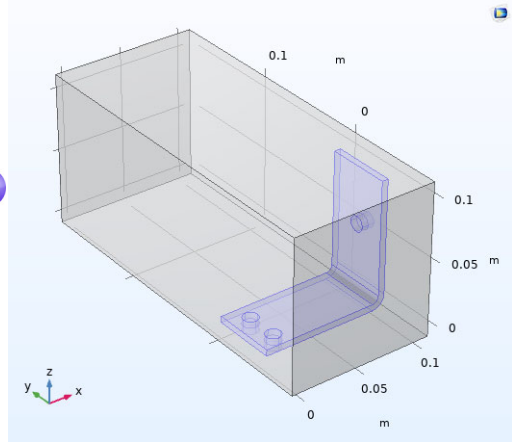
4



- 5 In the **Model Builder** window, right-click **Heat Transfer in Solids (ht)** . In the first section of the context menu, the domain level , select **Fluid**.

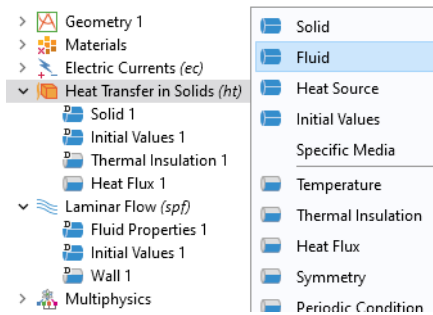

5

- 6 In the **Graphics** window, click the air domain (domain 1) to add it to the **Selection** list.

Now, couple the fluid flow and heat transfer phenomena.

6

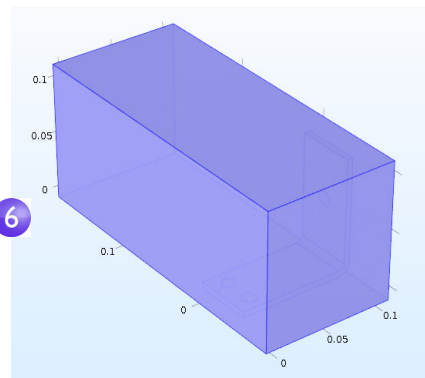

7 In the **Settings** window for **Fluid**, under **Heat Transfer in Solids**, in the section **Model Input**, select **Absolute pressure (spf)** from the **Absolute pressure** list. In the section **Heat Convection**, select **Velocity field (spf)** from the **Velocity field** list.

This identifies the pressure and flow field from the **Laminar Flow** interface and couples it to heat transfer.

Now, define the boundary conditions by specifying the inlet and outlet for the heat transfer in the fluid domain.

8 In the **Model Builder** window, right-click **Heat Transfer in Solids**. In the second section of the context menu, the boundary section, select **Temperature**.

A **Temperature** node is added to the model tree.

9 In the **Graphics** window, click the inlet boundary, boundary number 2, to add it to the **Selection** list.

This sets the inlet temperature to 293.15 K, the default setting.

The graphics should look like the image to the right. (It may look slightly different depending on whether you have **Transparency** and **Wireframe Rendering** on or off.) Continue by defining the outlet.

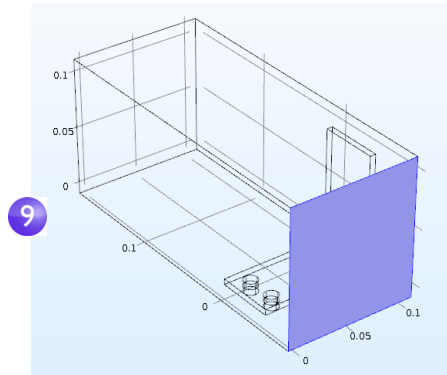
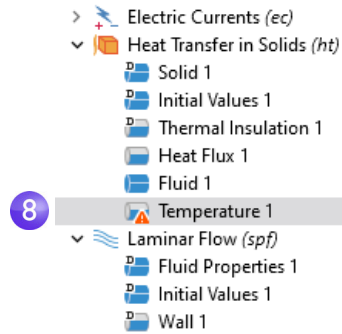
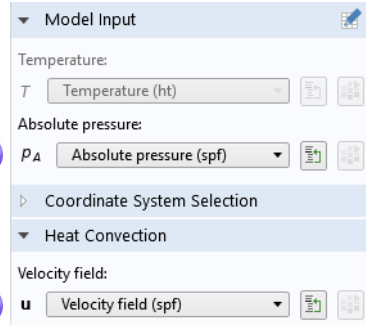



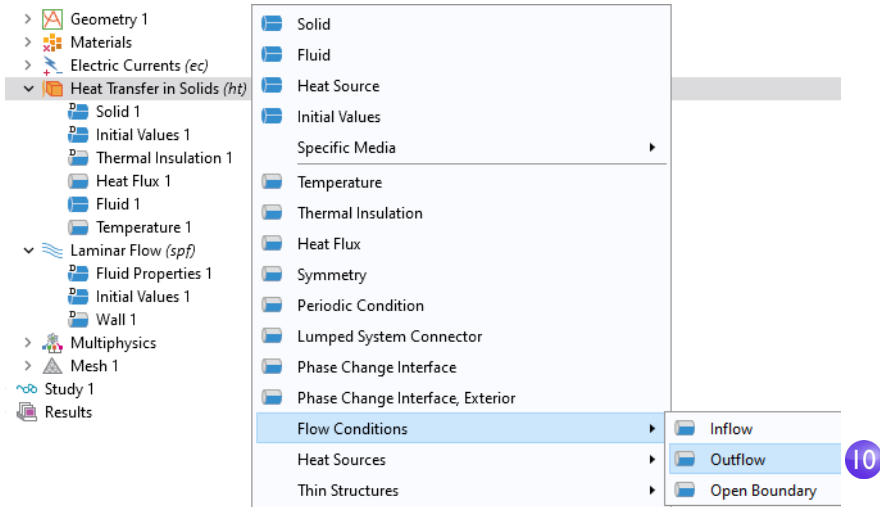

10 In the **Model Builder** window, right-click **Heat Transfer in Solids**. At the boundary level, select **Flow Conditions > Outflow**. An **Outflow** node is added to the model tree.



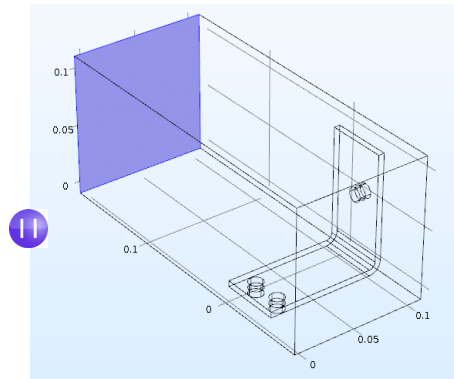

11 In the **Graphics** window, click the outlet boundary, boundary number 5, to add it to the **Selection** list. Use the mouse scroll wheel to scroll in and highlight the boundary before selecting it, or use the up and down arrow keyboard buttons.

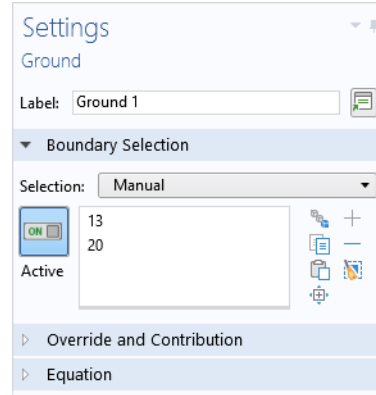
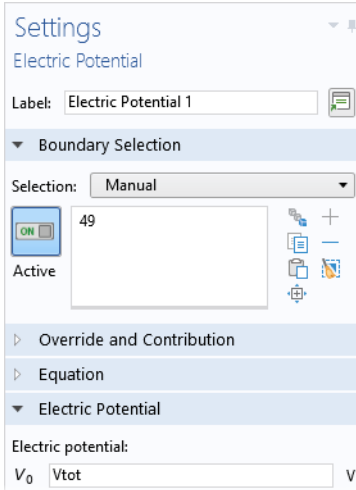

-  The settings for the busbar, the bolts, and the **Electric Potential I** and **Ground I** boundaries have retained the correct selection, even though you added the box geometry for the air domain. To confirm this, in the model tree under **Electric Currents**, click the **Electric Potential I** and the **Ground I** nodes to verify that they have the correct boundary selection.



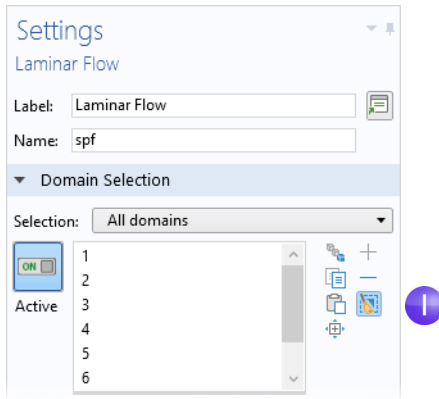

Next, continue with the flow settings. You need to indicate that fluid flow only takes place in the fluid domain and then set the inlet, outlet, and symmetry conditions. Do this by first removing all domains from the selection and then adding the air domain.

-  In the model tree, click the **Laminar Flow** node . In the **Settings** window for **Laminar Flow**, click the **Clear Selection** button .



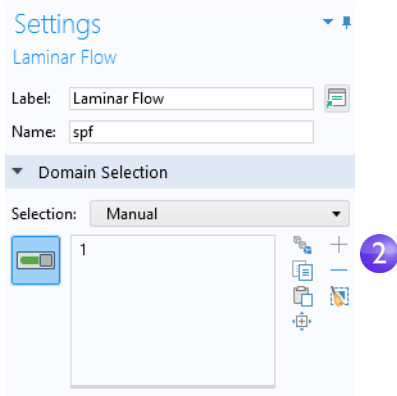

2 In the **Graphics** window, click the air box (domain 1) to add it to the **Selection**.



It is good practice to verify that the **Air** material under the **Materials** node has all of the properties that this multiphysics combination requires. In the model tree under **Materials**, click **Air**. In the **Settings** window for **Material** under **Material Contents**, verify that there are no missing properties, which are marked with a warning sign . The section “Materials” on page 89 has more information.



Now, we continue with the boundaries.

3 In the **Model Builder** window, right-click **Laminar Flow**  and at the boundary level, select **Inlet**. An **Inlet** node  is added to the model tree.

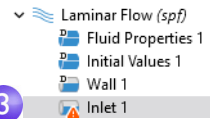

4 In the **Graphics** window, click the inlet (boundary 2) to add it to the **Selection** list.

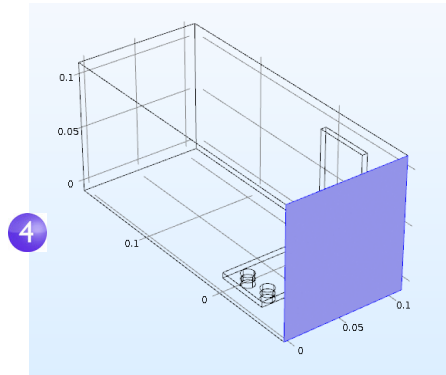

5 In the **Settings** window for **Inlet** under **Velocity** in the  $U_0$  field, enter  $V_{in}$  to set the **Normal inflow velocity**.

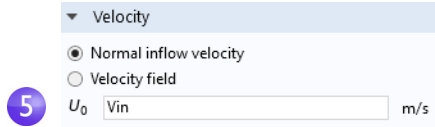

6 Right-click **Laminar Flow** and at the boundary level, select **Outlet**. In the **Graphics** window, click the outlet (boundary 5) to add it to the **Selection** list. Use the mouse scroll wheel or keyboard arrows to scroll in and highlight the boundary before selecting it.

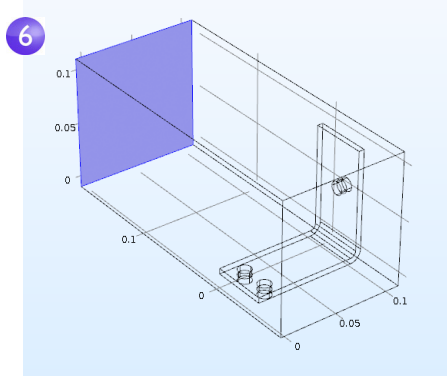

The last step is to add symmetry boundaries. For simplicity, assume that the flow just outside of the faces of the channel is similar to the flow just inside of these faces. This assumption can be correctly expressed by the symmetry condition.

7 Right-click **Laminar Flow** and select **Symmetry**. A **Symmetry** node is added to the sequence.

8 In the **Graphics** window, click each of the blue faces in the figure below (boundaries 1, 3, 4, and 48) to add all of them to the **Selection** list. You may need to use the mouse scroll wheel or rotate the geometry to select all of them.

Save the busbar\_box\_I.mph file, which now includes the **Air** material and **Laminar Flow** interface settings.

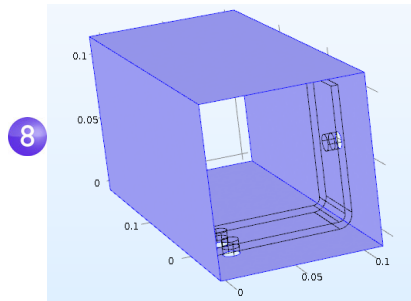



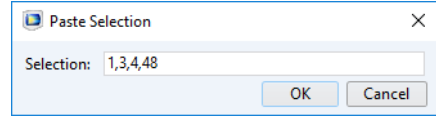

When you know the boundary numbers, you can click the **Paste Selection** button  and enter the information. In this example, enter 1,3,4,48 in the **Paste Selection** window. Click **OK** and the boundaries are automatically added to the **Selection** list.



## COARSENING THE MESH

To get a quick solution, we will change the mesh slightly and make it coarser. The current mesh settings would take a relatively long time to solve, and you can always refine it later.

- In the **Model Builder** window, expand the **Mesh 1** node  and click the **Size** node .



- In the **Settings** window for **Size** under **Element Size**, click the **Predefined** button and ensure that **Normal** is selected.

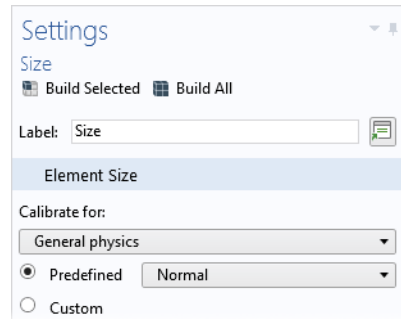

- Click the **Build All** button . The geometry displays with a mesh in the **Graphics** window (you may need to turn **Transparency** off to see the picture below).

You can assume that the flow velocity is large enough to neglect the influence of the temperature increase in the flow field.

It follows that you can solve for the flow field first and then solve for the temperature using the results from the flow field as input. This is implemented with a study sequence.

3

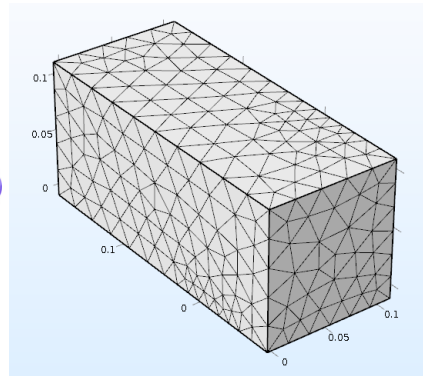

## SOLVING FOR FLUID FLOW AND JOULE HEATING

When the flow field is solved before the temperature field, it yields a weakly coupled multiphysics problem. The study sequence described in this section automatically solves such a weak, or one-directional, coupling.

- 1 In the model tree, right-click **Study 1** and select **Study Steps > Stationary > Stationary** to add a second stationary study step to the **Model Builder** window.

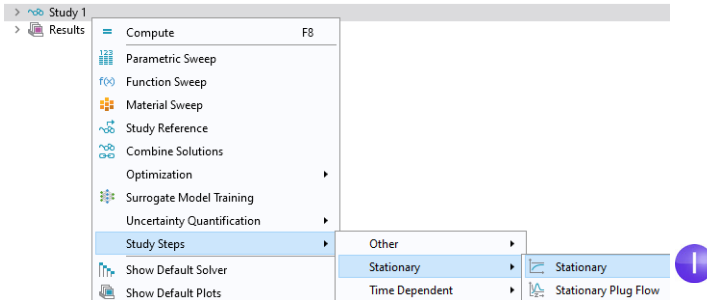

Next, the correct physics needs to be connected with the correct study step. Start by disabling the **Electric Currents (ec)** and **Heat Transfer in Solids (ht)** interfaces associated with Joule heating from the first step.

- 2 Under **Study 1**, click **Step 1: Stationary**.

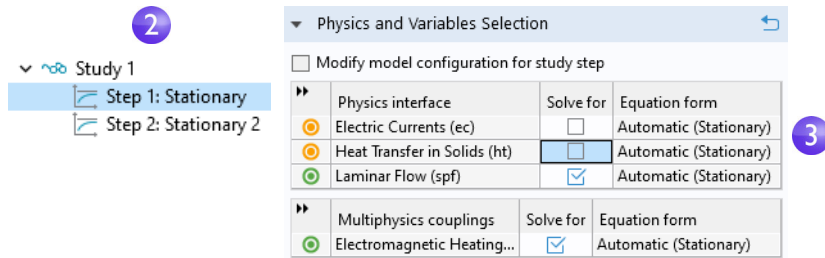

- 3 In the **Settings** window for **Stationary**, locate the **Physics and Variables Selection** section. In both the **Electric Currents (ec)** and the **Heat Transfer in Solids (ht)** rows, click to change the check mark  to an  in the **Solve for** column, removing the Joule heating effect from **Step 1**.

- 4 Repeat the step. Under **Study 1**, click **Step 2: Stationary 2**. Under **Physics and Variables Selection**, in the **Laminar Flow (spf)** row, click in the **Solve for** column to change the check mark  to an .

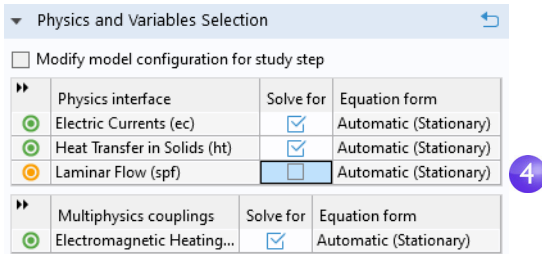

- 5 Right-click the **Study 1** node and select **Compute** (or press F8 or click **Compute** on the ribbon). This will now automatically create a new solver sequence that solves for laminar flow and then Joule heating.

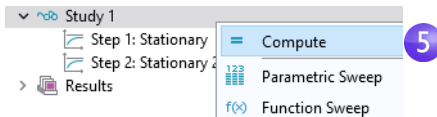

- 6 After the solution is complete, select the **Temperature (ht)** plot under the **Results** node in the **Model Builder** window. If you do not already have transparency on, click the **Transparency** button on the **Graphics** toolbar to visualize the temperature field inside the box. To zoom, middle-click and hold down the

mouse button (or scroll wheel) while dragging the mouse.

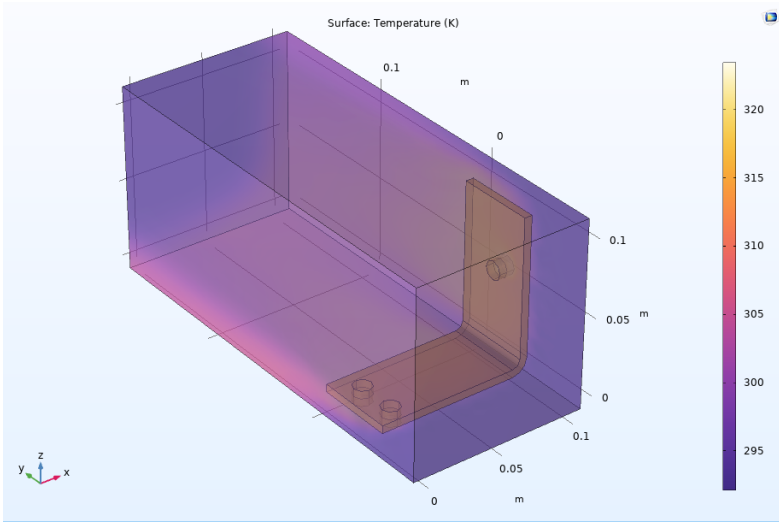

The **Temperature** plot that displays in the **Graphics** window shows the temperature in the busbar and in the surrounding box. You can also see that the temperature field is not smooth due to the relatively coarse mesh. A good strategy to get a smoother solution would be to refine the mesh to estimate the accuracy.

- 7 At this point, save the busbar\_box\_I.mph file so you can return to it at any time. The next steps use the original busbar.mph file.



# Parametric Sweeps

## SWEEPING A GEOMETRIC PARAMETER

It is often useful to generate multiple instances of a design with the objective of meeting specific constraints. In the previous busbar example, a design goal might be to lower the operating temperature or decrease the current density. We will demonstrate the former. Since the current density depends on the geometry of the busbar, varying the width, *wbb*, should change the current density and, in turn, have some impact on the operating temperature. Let us run a parametric sweep on *wbb* to study this change.

## ADDING A PARAMETRIC SWEEP

- 1 From the **File** menu, open the model file *busbar.mph*. If you did not save the model, you can also open it from the Application Libraries: **File > Application Libraries > COMSOL Multiphysics > Multiphysics > busbar**.

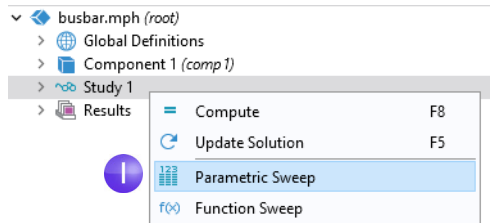

In the **Model Builder** window, right-click **Study 1** and select **Parametric Sweep**. A **Parametric Sweep** node is added to the **Model Builder** sequence.

- 2 In the **Settings** window for **Parametric Sweep**, under the empty parameter table, click the **Add** button **+**. From the **Parameter names** list in the table, select *wbb*.

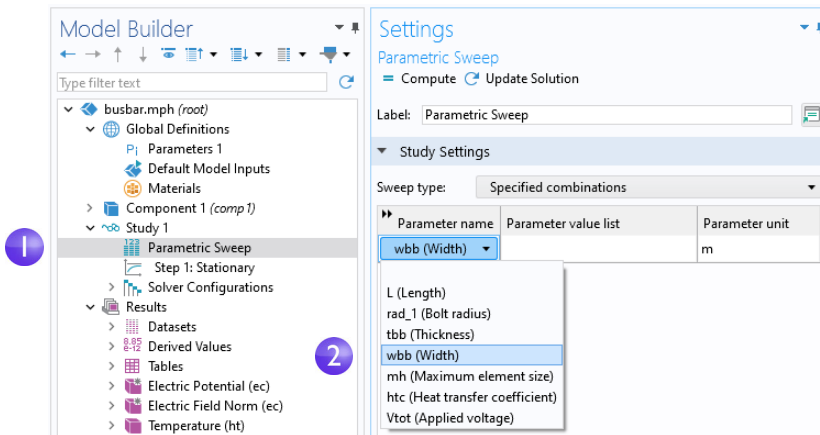



The **Sweep type** is used to control parametric sweeps with multiple parameters. You can choose between sweeping for **All combinations** of the given parameters, a subset of **Specified combinations**, or **Parameter switch**. The option **Parameter switch** makes it possible to sweep over **Cases** for **Parameters**, as defined in **Global Definitions** (shown below).

The screenshot shows the Model Builder interface on the left and the Settings window on the right. The Settings window is titled "Case" and shows a list of parameters for "Case 1".

Name	Expression	Description
L	9[cm]	Length
rad_1	6[mm]	Bolt radius
tbb	5[mm]	Thickness
wbb	5[cm]	Width
mh	3[mm]	Maximum element size
htc	5[W/m^2/K]	Heat transfer coefficient
Vtot	20[mV]	Applied voltage

The screenshot shows the Settings window for "Parametric Sweep". The "Sweep type" is set to "Parameter switch". The "Switch" table is configured as follows:

Switch	Cases	Case numbers
Parameters	All	range(1,1,3)

Note that you can replace the set of main **Parameters** used in the model with that of a **Case** by selecting from the menu in the upper-left corner of the **Parameters** window.

The screenshot shows the Model Builder interface on the left and the Settings window on the right. The Settings window is titled "Parameters" and shows a list of parameters for "Case 2". A dropdown menu is open, showing "Case 1", "Case 2" (selected), and "Case 3".

Name	Expression	Value	Description
L	9[cm]	0.09 m	Length
rad_1	6[mm]	0.006 m	Bolt radius
tbb	5[mm]	0.005 m	Thickness
wbb	5[cm]	0.05 m	Width
mh	3[mm]	0.003 m	Maximum element size
htc	5[W/m^2/K]	5 W/(m^2·K)	Heat transfer coefficient
Vtot	20[mV]	0.02 V	Applied voltage

- 3 Enter a range of parameter values to sweep the width of the busbar from 5 cm to 10 cm in 1 cm increments. There are different ways to enter this information:
- Copy and paste or enter range (0.05,0.01,0.1) into the **Parameter value list** field.
  - Click the **Parameter value list** field and then click the **Range**  button and enter the values in the **Range** dialog box. In the **Start** field, enter 0.05. In the **Step** field, enter 0.01, and in the **Stop** field, enter 0.1. Click **Replace**.
  - In any of the methods, you can also use length units to override the default SI unit system using meters. Instead of 0.05, you can enter 5[cm]; similarly, 1[cm] instead of 0.01 and 10[cm] instead of 0.1. You can also change the default unit system from the **Settings** window of the root node in the model tree.

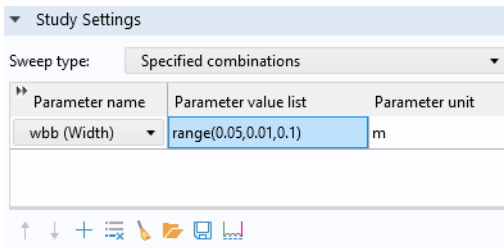
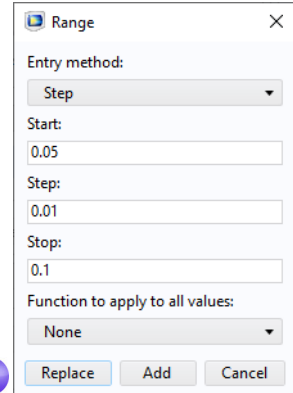

Next, define an **Average** nonlocal coupling that can be used later to calculate the average temperature in the busbar.

4 Under **Component 1**, right-click **Definitions**  $\equiv$  and select **Nonlocal Couplings > Average**  $_{AV}$  .

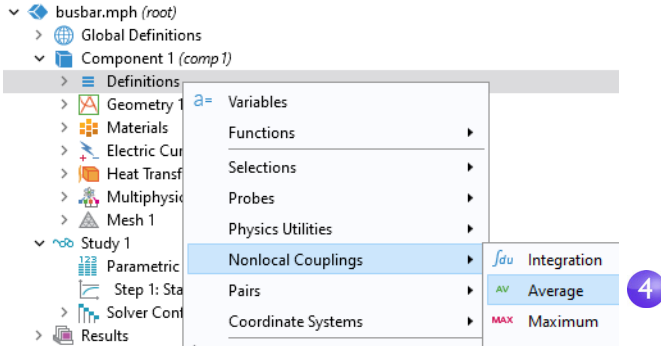

5 In the **Settings** window for **Average**, select **All domains** from the **Selection** list.

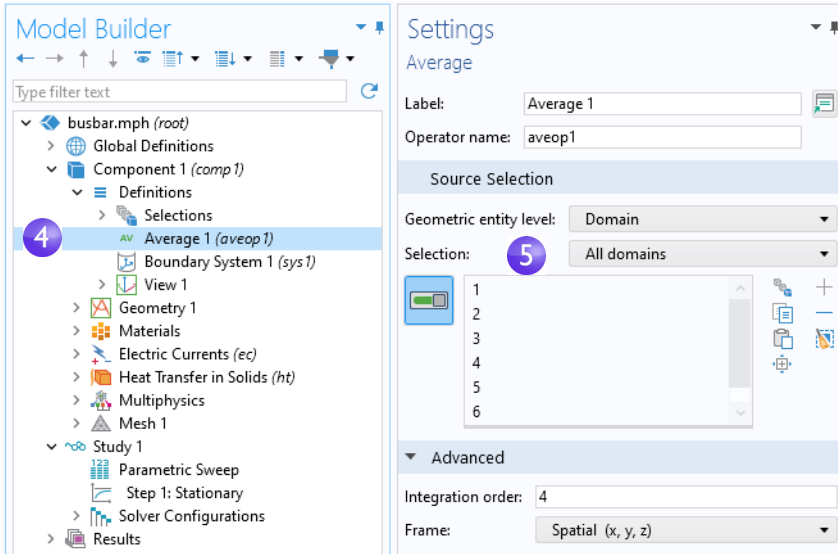

This creates an operator called `aveop1`. This operator is now available to calculate the average of any quantity defined on the selected domains. Later, we use this tool to calculate the average temperature, but it can also be used to calculate average electric potential, current density, and so forth.

6 Select **File > Save As** to save the model with the new name, `busbar_III.mph`.

7 To run the sweep, right-click **Study 1**  $\infty$  and select **Compute**  $=$  or click **Compute** in the **Home** tab.

## PARAMETRIC SWEEP RESULTS

Click the **Temperature (ht) 1** node (the second temperature plot node) located under **Results** in the model tree.

The plot that displays in the **Graphics** window shows the temperature in the wider busbar using the last parameter value,  $wbb=0.1$  [m] (10 [cm]). Select **Zoom Extents**  from the **Graphics** window toolbar so that you can see the entire plot. The resulting plot is rather uniform in color, so we need to change the maximum color range.

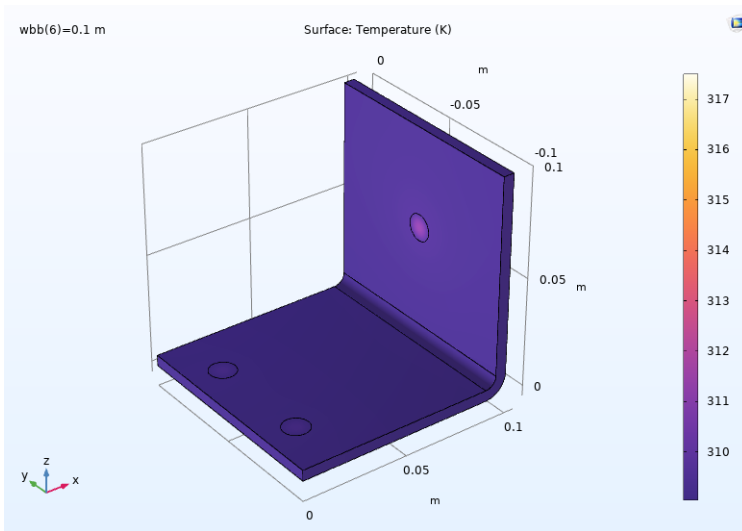
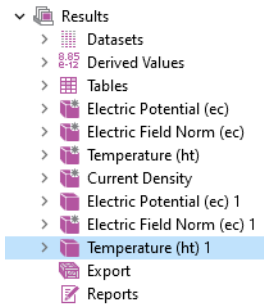

Under the **Temperature (ht) 1** node, click the **Volume 1** node .

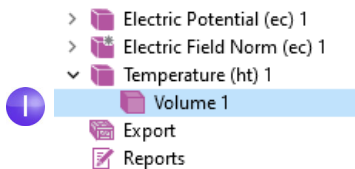

- 2 In the **Settings** window for **Volume**, click **Range** to expand the section. Select the **Manual color range** check box. Enter 309.5 in the **Maximum** field (replace the default).
- 3 The **Temperature (ht) 1** plot is updated in the **Graphics** window for  $wbb=0.1\text{ [m]}$  (10[cm]).

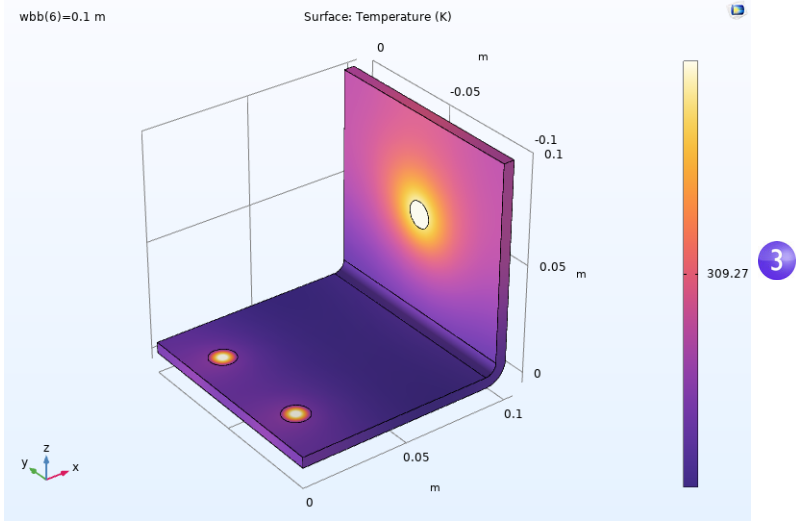
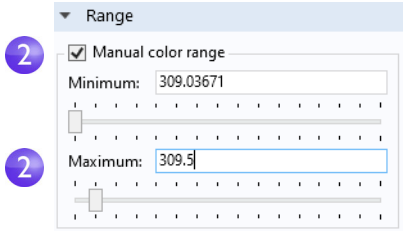

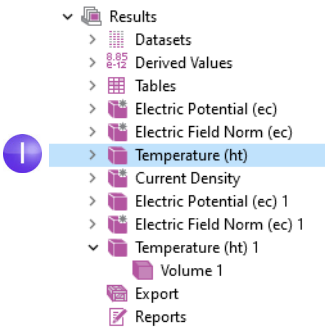

The plot may look a bit different depending on which version you are running. Compare the wider busbar plot to the temperature for  $wbb=0.05\text{ [m]}$  (5[cm]). For this purpose, you can reuse one of the previously defined plot groups.

- 1 In the **Model Builder** window, click the first **Temperature (ht)** node .



2 In the **Settings** window for **3D Plot Group**, select **Study 1/Parametric Solutions 1** from the **Dataset** list. This dataset contains the results from the parametric sweep.

3 In the **Parameter value** list, select **0.05** (which represents  $wbb=5\text{ cm}$ ). Click the **Plot** button . Click the **Zoom Extents** button  on the **Graphics window** toolbar.

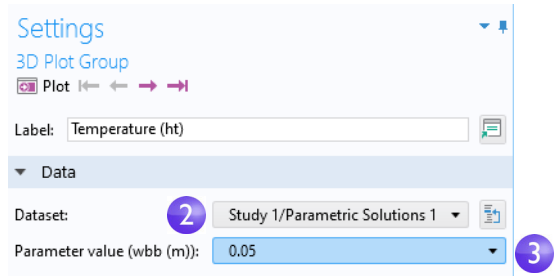

The **Temperature (ht)** plot is updated for  $wbb=0.05\text{ [m]}$  ( $5\text{ [cm]}$ ). Note that if you have updated the color range for this plot already, your plot should look similar to the one below. If not, follow the subsequent steps.

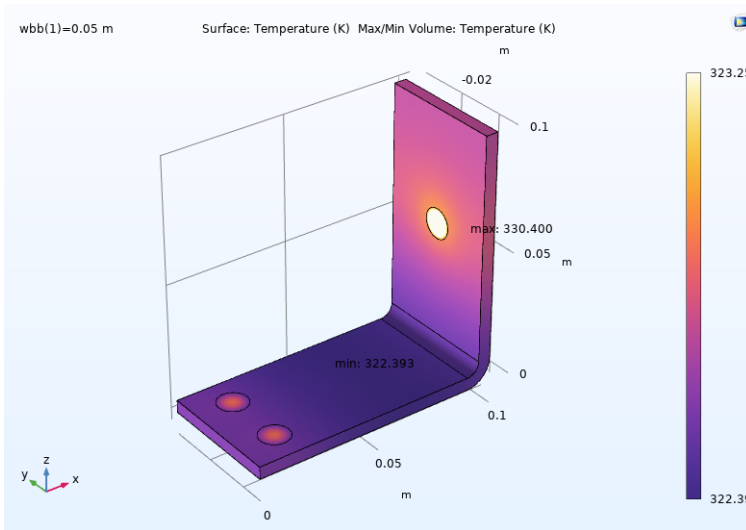

(The plot may include the maximum and minimum points, depending on which version of the model you started from.) Like the wider busbar, the plot may be quite uniform in color, so change the maximum color range.

- 1 Under the first **Temperature (ht)** node, click the **Volume** node .
- 2 In the **Settings** window for **Volume**, click **Range** to expand the section (if it is not already expanded). Select the **Manual color range** check box.



3 Enter 323.25 in the **Maximum** field (replace the default).

The **Temperature (ht)** plot is updated in the **Graphics** window for  $w_{bb}=0.05$  [m] (5 [cm]).

Click the first and second **Temperature** plot nodes to compare the plots in the **Graphics** window. The maximum temperature decreases as the width of the busbar increases from 5 cm to 10 cm.

### ADDING MORE PLOTS

To further analyze these results, you can plot the average temperature for each width.

1 Right-click **Results**  and add a **1D Plot Group** .

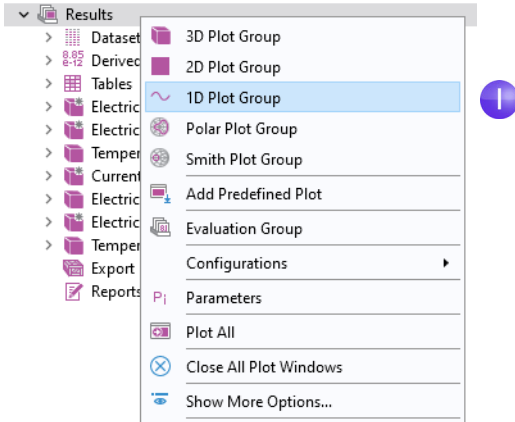

2 In the **Settings** window for the **1D Plot Group**, select **Study 1/Parametric Solutions 1** from the **Dataset** list.

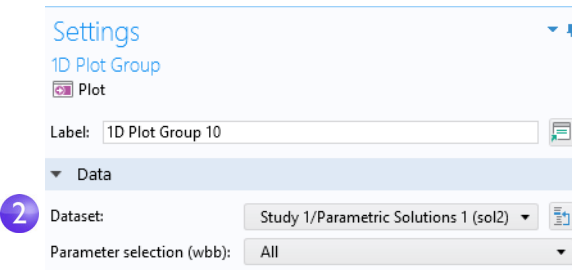



3 In the **Model Builder** window, right-click **ID Plot Group** and add a **Global** node.

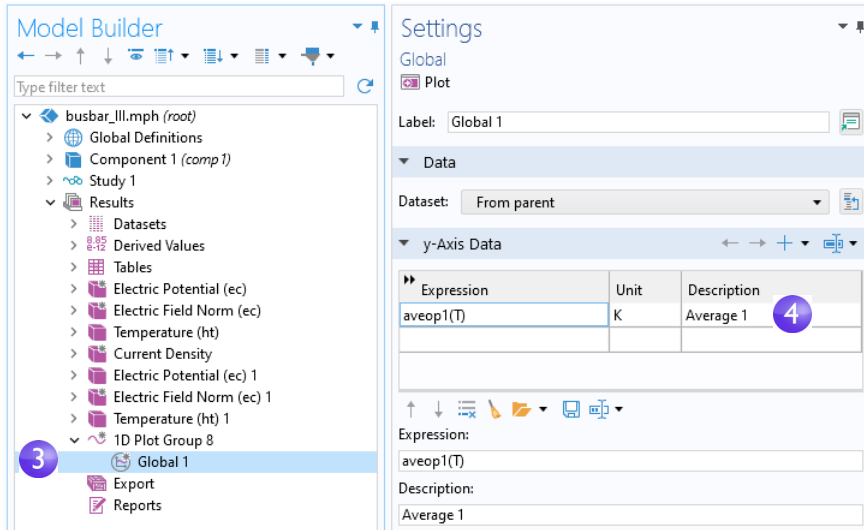

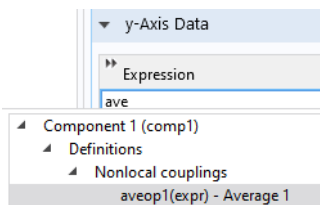

4 In the **Settings** window for **Global** under **y-Axis Data**, click the first row in the **Expressions** column and enter `aveop1(T)`. This is the operator that we defined on page 172 for later use. You use a similar syntax to calculate the average of other quantities.

! You can also use auto-completion by using **Ctrl+Space** after clicking the first row or after typing a few characters.

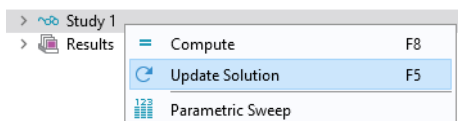

! To use a nonlocal coupling operator without solving, you can select the option **Update Solution** that is available by right-clicking a **Study** node.



5 Click the **Plot** button  and save the busbar\_III.mph model with these additional plots that use the parametric sweep results.

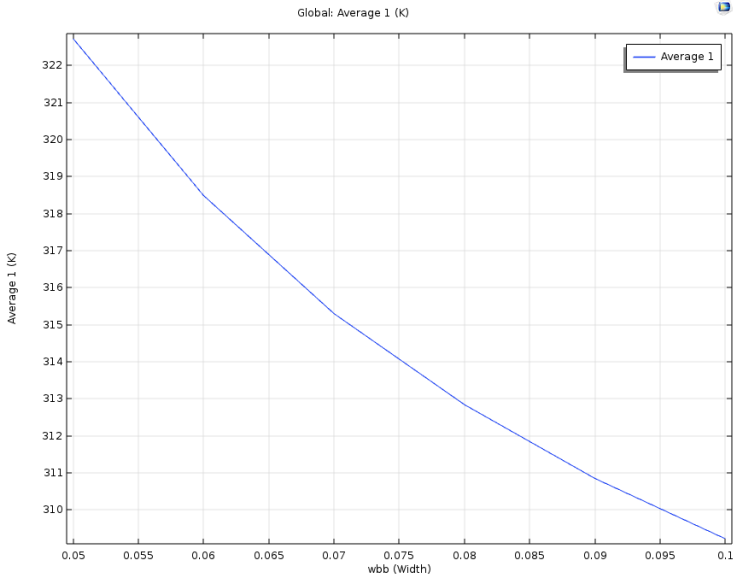

In the plot, the average temperature decreases as the width increases.

### PARAMETERS IN RESULTS

For greater flexibility, it is possible to define parameters that are only used in the **Results** node. Using these parameters does not require resolving the model. The following example shows how you can animate over a **Parameter** defined under **Results**.

1 Right-click the **Results** node and select **Parameters**.

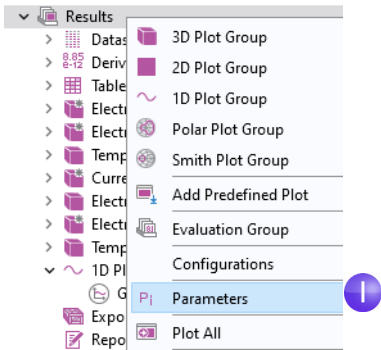

2 Define a parameter, `iso_level`, with **Expression** `309.5[K]`.

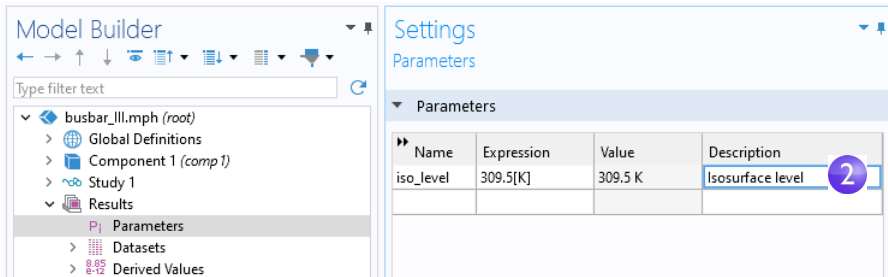

3 Right-click the **Results** node and add an **Isothermal Contours** plot, from the **Heat Transfer in Solids** branch of **Study 1/Solution 1**. For the **Isothermal Contours (ht)** plot group, in the **Settings** window for the **Isosurface** plot, change the **Entry** method to **Levels**. For the **Levels** expression field, type `iso_level`.

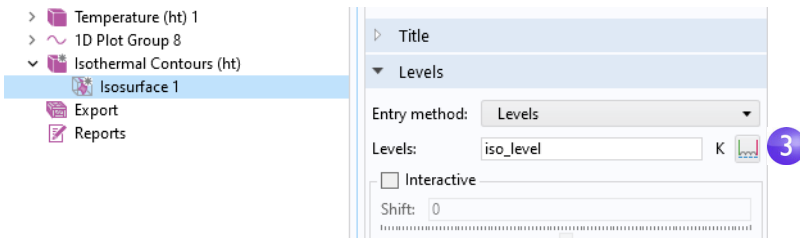

4 In the same **Settings** window, click **Plot**.

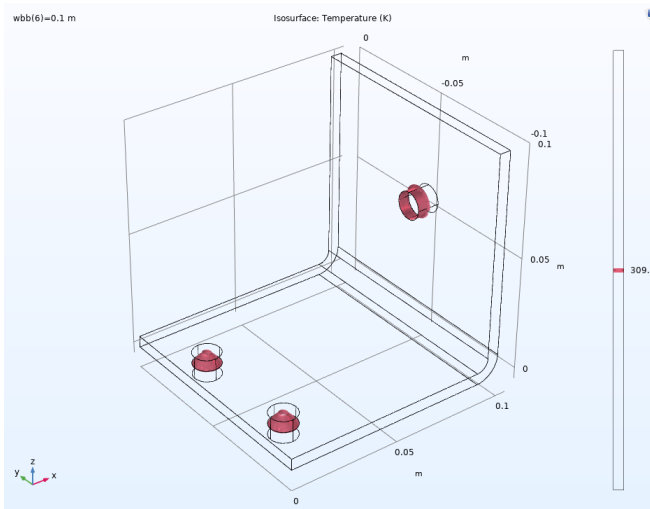

- 5 Generate an **Animation** by either selecting the **Player** option in the **Animation** menu of the **Isothermal Contours (ht)** I tab on the ribbon, or right-click the **Export** node and select **Animation > Player**.

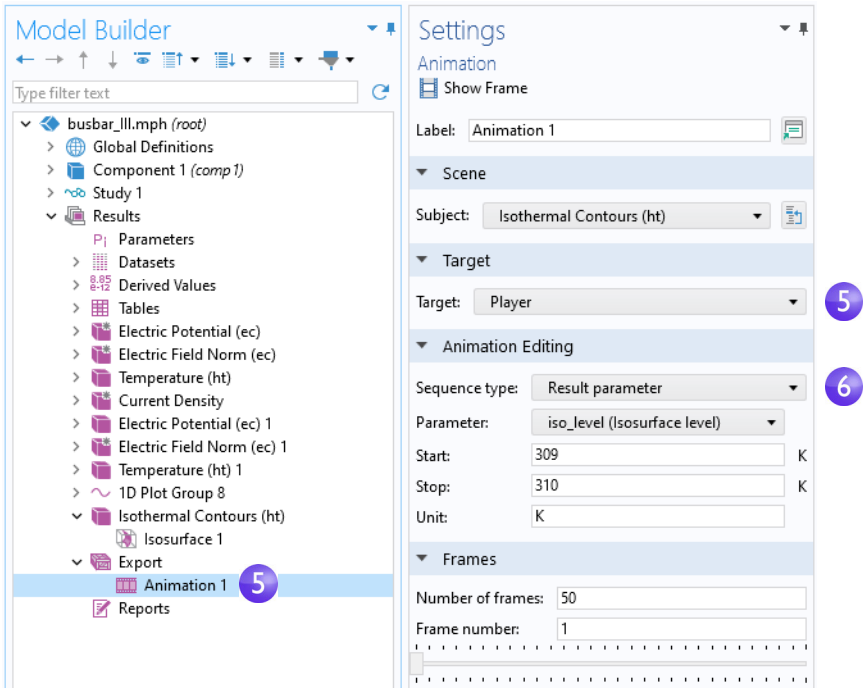

- 6 In the **Settings** window for **Animation**, change the **Sequence type** to **Result parameter** and select the `iso_level` parameter. Type 309 for **Start** and 310 for **Stop**. Click the **Play** button in the **Graphics** toolbar or the **Show Frame** button in the **Settings** window for **Animation**. To get a smoother animation, change the **Number of frames** to a higher number; for example, 50.

The subject of parametric sweeps raises the question of parallel computing; it would be efficient if all parameters were solved simultaneously.

## Parallel Computing

COMSOL Multiphysics and COMSOL Server support most forms of parallel computing, including shared-memory parallelism for multicore processors and high-performance computing (HPC) for clusters and clouds. All COMSOL licenses are multicore enabled. For cluster or cloud computing, including parallelized sweeps, a Floating Network License (FNL) is needed.

You can use clusters or clouds with one of two options: **Cluster Sweep** or **Cluster Computing**. If you have an FNL, these two options are available by right-clicking the **Study** node. However, you first need to enable the **Batch and Cluster** study options by clicking the **Show More Options** button  on the **Model Builder** toolbar and selecting **Batch and Cluster** in the **Show More Options** dialog box.

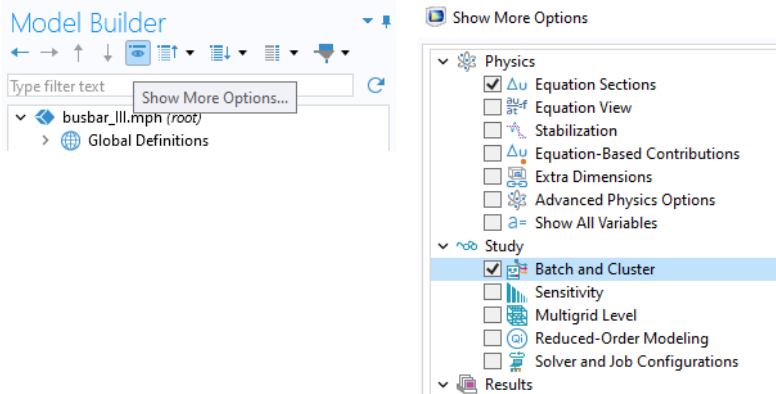

## CLUSTER SWEEP

The **Cluster Sweep** option is used for solving several models in parallel where each model has a different set of parameters. This can be seen as a generalization of **Parametric Sweep**. Right-click the **Study** node to add a **Cluster Sweep** node.

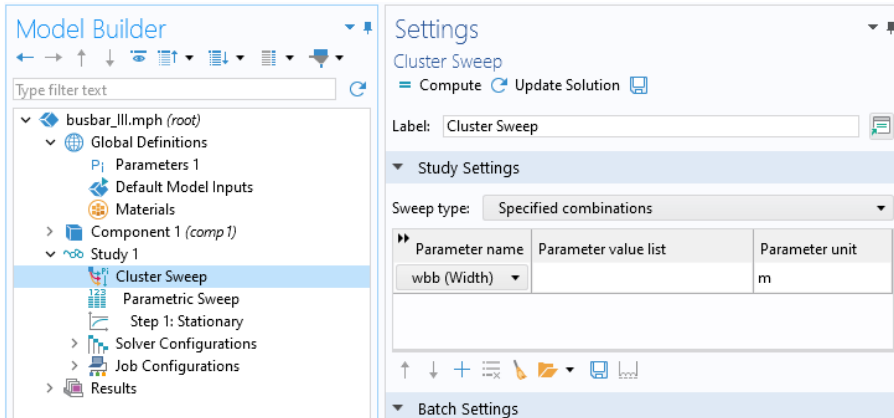

The **Study Settings** for **Cluster Sweep** are similar to that of **Parametric Sweep**, but additional settings are required for the cluster or cloud being used. The picture above shows how the top of the **Settings** window for **Cluster Sweep** would look for the same sweep as defined in “Parametric Sweeps” on page 169. To add and run a **Cluster Sweep** in this case, you would first remove the **Parametric Sweep** node.

## CLUSTER COMPUTING

You can also utilize a cluster or cloud to solve a single large model using distributed memory. For maximum performance, the COMSOL software cluster implementation can utilize shared-memory multicore processing on each node in combination with the Message Passing Interface (MPI) shared-memory model. This is also known as hybrid parallelism and brings a major performance boost by making the most out of the computational power available.

Right-click the **Study** node to add a **Cluster Computing** node. A **Cluster Computing** node cannot be used in combination with a **Cluster Sweep**. You will be asked if you want to remove the **Cluster Sweep** before proceeding. Select **Yes**.

The **Settings** window for **Cluster Computing**, shown below, helps to manage the simulation with settings for the cluster or cloud.

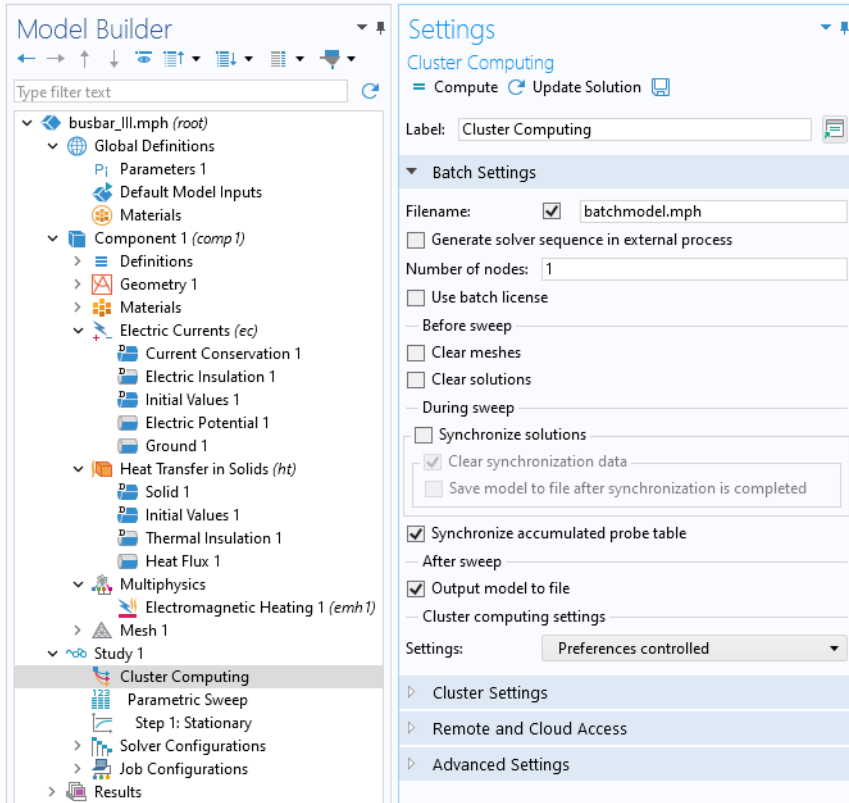

The **Settings** menu under **Cluster computing settings** has two options: **Preferences controlled** or **User controlled**. The figure above shows the **Preferences controlled** option. For the **Preferences controlled** option, the settings are defined in the **Preferences** dialog box in the **File** menu.

For the **User controlled** option, you choose the type of cluster job you want to perform from the **Scheduler type** list.

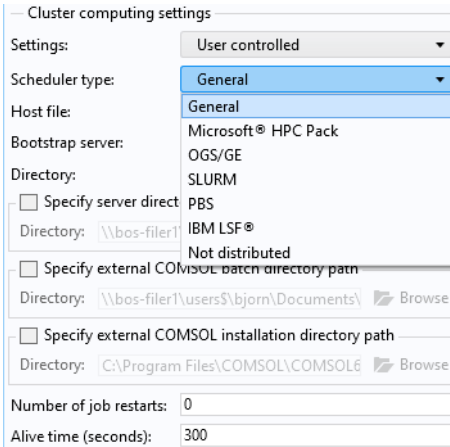

Cluster computing settings

Settings: User controlled

Scheduler type: General

Host file: General

Bootstrap server: Microsoft® HPC Pack

Directory: OGS/GE

SLURM

Specify server directory path: PBS

Directory: \\bos-filer\ Directory: \\bos-filer\users\$bjorn\Documents\ Browse

Specify external COMSOL batch directory path: IBM LSF®

Directory: Not distributed

Specify external COMSOL installation directory path

Directory: C:\Program Files\COMSOL\COMSOL6 Browse

Number of job restarts: 0

Alive time (seconds): 300

COMSOL Multiphysics and COMSOL Server support General, Microsoft® HPC Pack, Open Grid Scheduler/ Grid Engine (OGS/GE), SLURM, PBS, IBM LSF®, or Not distributed. The **General** option is a multipurpose option for Linux® clusters. Additional cluster and scheduler settings, such as **Prepend command** and **Postpend command**, are available in the **Preferences** window in the **File** menu.

To learn more about running in parallel, see the *Reference Manual*.



The **Cluster Sweep** and **Cluster Computing** options are only visible if you have an FNL and have enabled the **Batch and Cluster** study options.



## COMSOL Multiphysics Client–Server

When using COMSOL Multiphysics with an FNL, it is possible to use a client–server mode of operation to access remote computing resources for solving large models, while still using the graphics card on a local machine to display graphics. This mode of operation should not be confused with the use of Windows<sup>®</sup> Remote Desktop, and similar technologies, to connect to a COMSOL Multiphysics session, or the use of the COMSOL Server product for use with COMSOL applications.

Using the COMSOL Multiphysics client–server mode can have some significant advantages, since engineering and scientific computing problems involve working with large amounts of data — anywhere from megabytes to gigabytes of data are commonly generated during a simulation. To generate and store this data, you may want to use computers with fast processors, large amounts of Random Access Memory (RAM), and a large hard drive. To visualize large datasets, it is important to have a high-end graphics card on your local computer.

Under ideal conditions, you would always be working on a high-end computer with more than enough memory and processing power for all of the simulation steps. If this is not the case and you need to solve larger models, you may instead access a shared computing resource across a network.

At any time while using COMSOL Multiphysics, it is possible to connect to a remote computing resource via the client–server mode of operation. This is a two-step process. First, log onto the remote system and invoke the COMSOL Multiphysics server, which will start the COMSOL Multiphysics server process and open a network connection. Second, on the local machine, simply enter the network connection information into an open session of COMSOL Multiphysics. The software then transparently streams the model data and results back and forth over the network and uses the remote computing resource for all computations.

There are several ways to start a COMSOL Multiphysics server session. In Windows<sup>®</sup> 10, you can start a server session from the **COMSOL Launchers** option from the Windows start menu.

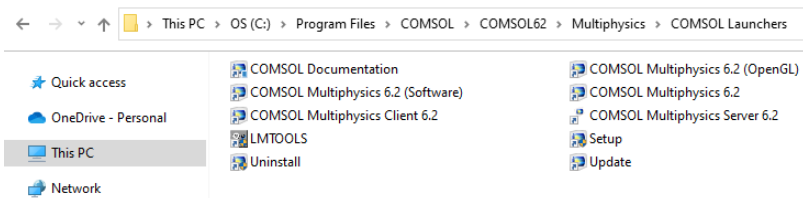

In Linux<sup>®</sup>, you can use the `comsol mphserver` command. The server and client sessions can be run on different operating systems. For example, the server can run in Linux<sup>®</sup> and the client session in Windows<sup>®</sup>.

The first time you start a COMSOL Multiphysics server on a computer, you are asked for a username and password that are associated with the client-server mode of operation and stored for future connections. The figure below shows the command window for starting a server session in Windows<sup>®</sup>.

```
COMSOL Multiphysics Server 6.2
Username: paul
Password:
Confirm password:
COMSOL Multiphysics server 6.2 (Build: 252) started listening on port 2036
Use the console command 'close' to exit the program
```

The figure below shows how to connect to a server session from the COMSOL Desktop user interface. From the **File** menu, select **COMSOL Multiphysics Server > Connect to Server** to connect.

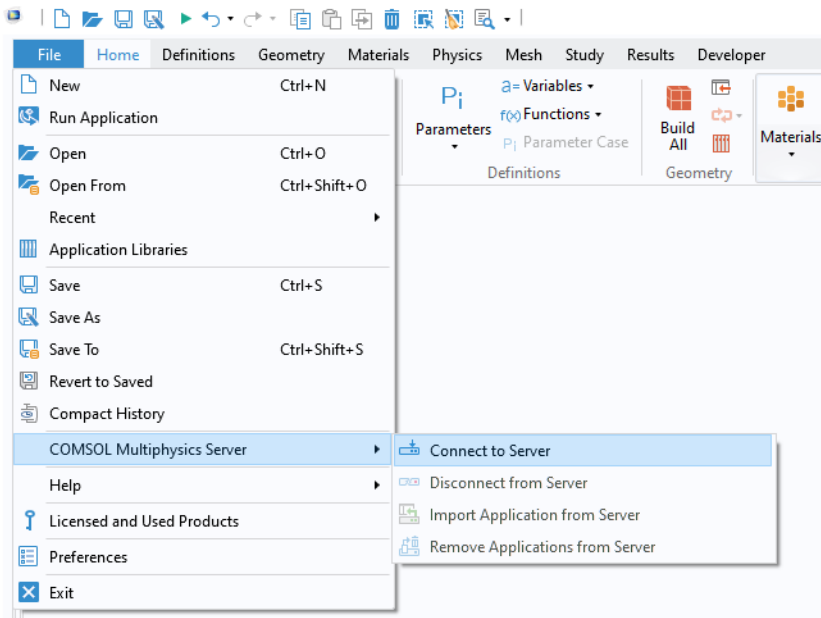

You are now prompted for the username and password that you gave the first time you started a server session.

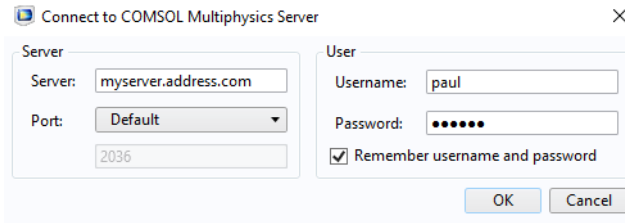

The screenshot shows a dialog box titled "Connect to COMSOL Multiphysics Server" with a close button (X) in the top right corner. The dialog is divided into two main sections: "Server" and "User".

**Server Section:**

- Server: myserver.address.com
- Port: Default (dropdown menu)
- 2036 (input field)

**User Section:**

- Username: paul
- Password: ••••••
- Remember username and password

At the bottom right, there are two buttons: "OK" and "Cancel".

For more information on running the COMSOL Multiphysics client–server, see the *Reference Manual*.

## Using the Model Manager

---

This section gives a brief introduction to using the Model Manager for simulation data management. The Model Manager allows users to collaborate and centrally organize models and apps and provides tools for version control, efficient storage, searching for MPH-file contents, and more. A database can either be stored locally on your computer for personal use, or, if you have an FNL, accessed remotely from a server for collaborative use. You will learn how to create a local Model Manager database, store simulation data, and control versions.

For detailed information on using the Model Manager, see the book *Model Manager Reference Manual*.

## Creating a Local Database

Assuming you have not already created a local database, this is how you create one in order to get started using the Model Manager.

In the **File** menu, the **Open** and **Save As** menu items let you open and save files to a local or shared file system. The **Open From** and **Save To** menu items also let you open and save to a Model Manager database.

- 1 From the **File** menu, select  **Open From**.

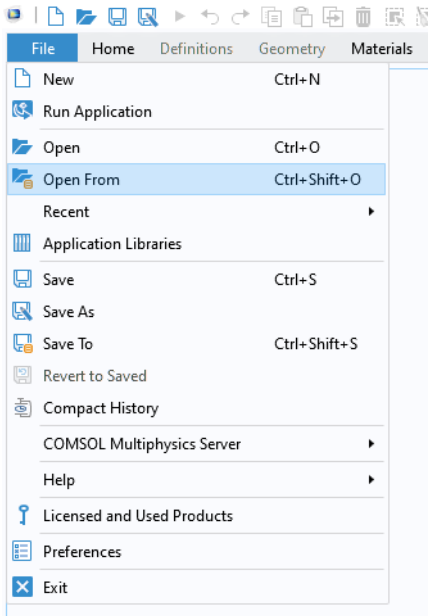

- 2 In the **Open** window, choose  **Add Database** in the list of options.

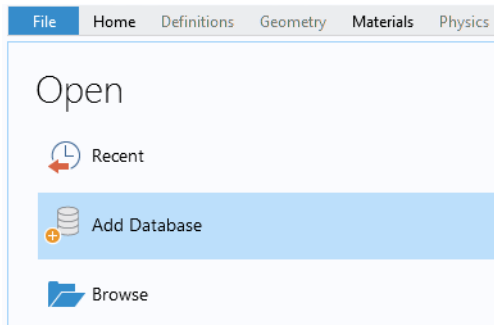

3 In the **Add Database** window, choose **New Local Database**  .

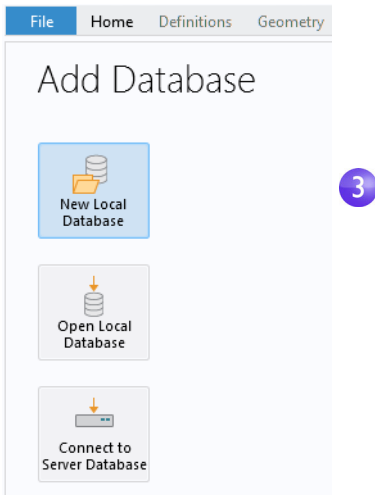

4 In the **New Local Database** window, type `Modeling Example` as the name for the new database in the **Name** field. You can choose a more suitable name if you intend to keep using this database.

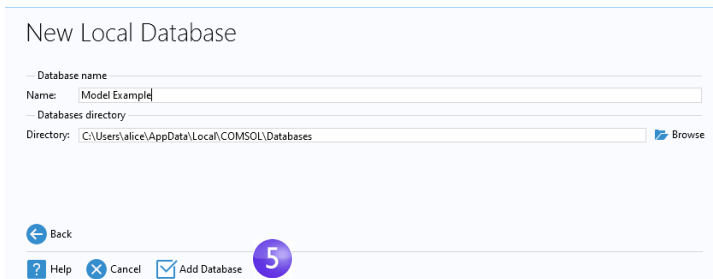

5 Click  **Add Database**.

A progress window is displayed, informing you that the database is being created on the file system.

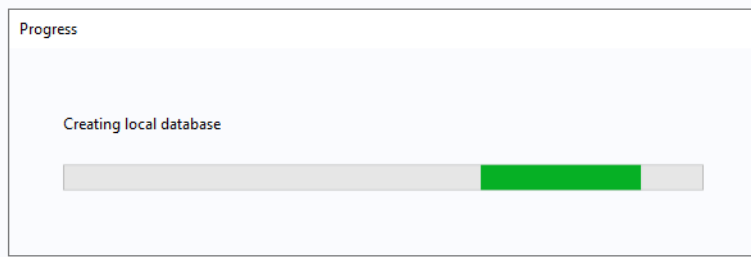

Once finished, the **Open** window is shown with the newly created database selected in the list.

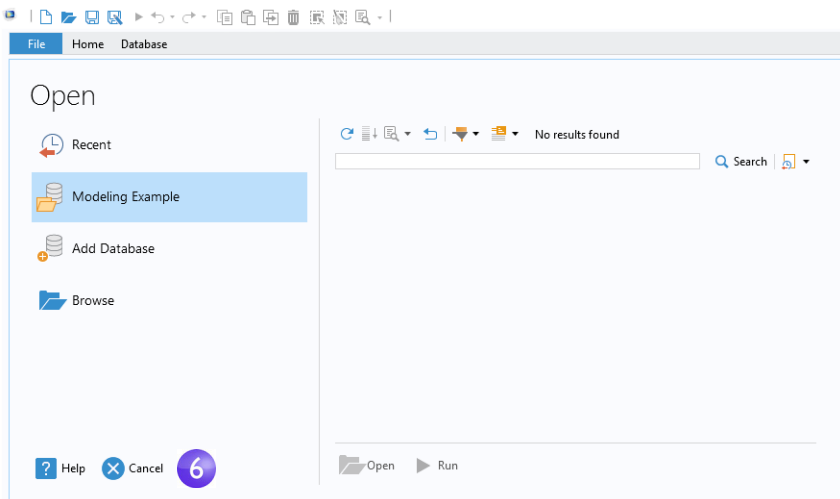





6 From the **Open** window, you can search the database for models to open. At the moment, your database is empty. Click **Cancel**.

## Version Control

---

### MODEL WIZARD SETUP

For the purpose of demonstrating using the Model Manager, we will revisit the wrench model “Example 1: Structural Analysis of a Wrench” on page 38 and start anew from the **Model Wizard**.

- 1 From the **File** menu, select **New**. In the **New** window, choose **Model Wizard**.
- 2 In the **Select Space Dimension** window, select **3D**.
- 3 In **Select Physics**, select **Structural Mechanics > Solid Mechanics (solid)** . Click **Add**. Click **Study**  to continue.
- 4 Click **Stationary**  under **Preset Studies**. Click **Done**  once finished.

### SAVING A FIRST VERSION

Place your new model under version control by saving it to your database.

- 1 From the **File** menu, select  **Save To**.
- 2 In the **Save** window, choose your newly created database, Modeling Example, from the list of options.  
The **Save** window updates with the selected database set as the target for the save. The header reads **Save new** as the model is not yet present in the database.
- 3 Type 3D stationary solid mechanics in the empty **Title** field.



- 4 You can type an optional comment describing what you are saving in the **Comments** field. Type Setup for a 3D solid mechanics model using a stationary study.

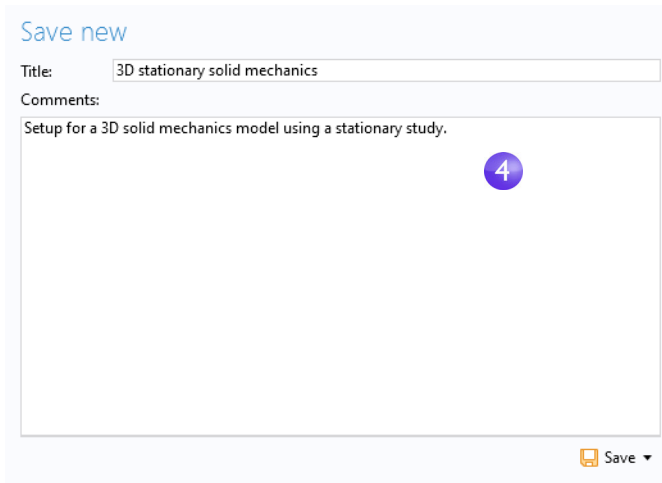



- 5 Click the **Save** button (  ).

A first version of the model is now saved in the Modeling Example database.

Click the root node in the **Model Builder** window. The **Title** field in the **Presentation** section of the **Settings** window has been updated with the title you gave when saving.

## SAVING ADDITIONAL VERSIONS

The model uses a geometry that was previously created and stored in the COMSOL native CAD format mphbin.

- 1 In the Model Builder window, right-click **Geometry 1**  and select **Import** .

- 2 In the **Settings** window for **Import**, from the **Source** list, select the COMSOL Multiphysics file.

- 3 Click **Browse**  and locate the file wrench.mphbin in the applications folder of the COMSOL installation folder. Its default location in Windows® is

```
C:\Program Files\COMSOL\COMSOL62\Multiphysics\applications\  
COMSOL_Multiphysics\Structural_Mechanics\wrench.mphbin
```

Double-click to add, or click **Open**.

- 4 Click **Import**  to display the geometry in the **Graphics** window.

- 5 Select **Geometry 1**  and click the **Build All** button  in the **Settings** window.

With the geometry imported to the model, save a second version:

| From the **File** menu, select  **Save as Version**.

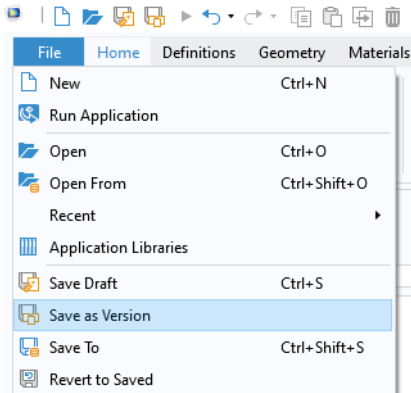

The **Save** window opens with your database preselected in the list of options.

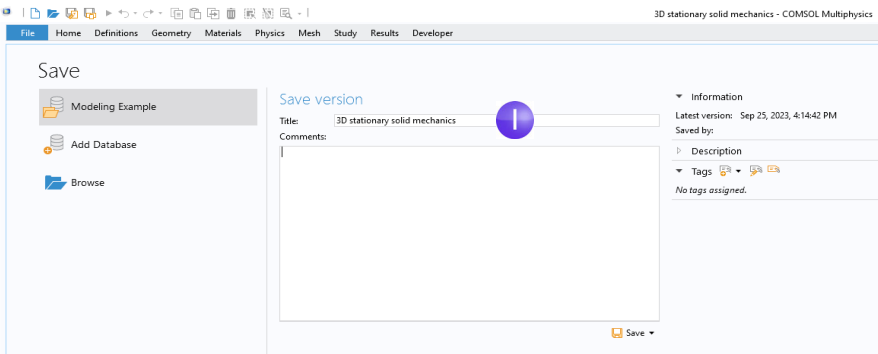

The header reads **Save version**, as the model already exists in the database. The title is the same as when saving the first version.

- 2 In the **Title** field, change the title to Structural analysis of a wrench and type Added a geometry for a wrench in the **Comments** field.

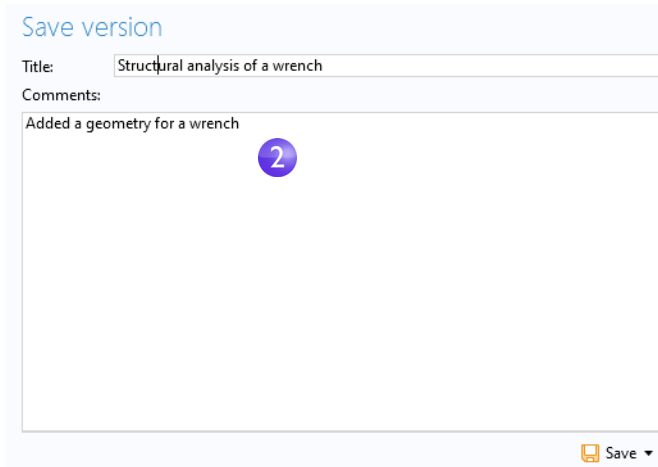

Save version

Title:

Comments:

Added a geometry for a wrench

2

Save ▾

- 3 Click the  **Save** button.

You now have two versions of the model saved in your database.

For the purpose of demonstrating multiple versions, we will make a small change to the model and save another version by adding a description to the model. This will be the third version.

- 1 Click the root node in the **Model Builder** window.
- 2 In the **Description** field under the **Presentation** section, type Analysis of the mechanical stress level in a wrench.
- 3 From the **File** menu, select  **Save as Version**.

4 Type Added a description. in the **Comments** field. Click  **Save**.

Save version

Title:



Comments:

Added a description. 

 Save ▾

## THE VERSIONS WINDOW

Up to this point, you have saved three versions of the model in the database.

- 1 From the **Windows** menu  in the **Layout** section of the **Home** tab, select  **Versions** to open the **Versions** window.

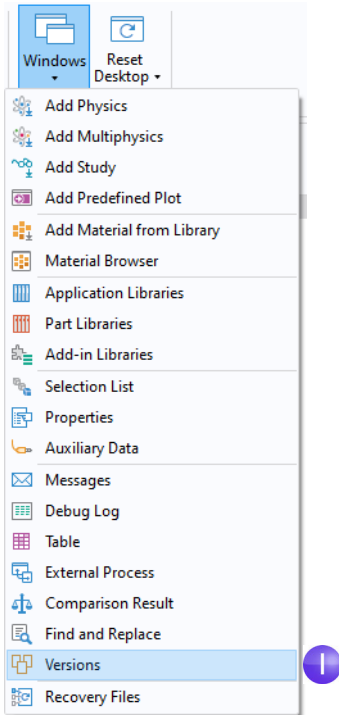

- 2 You will see the three versions in a table in chronological order, with the most recent version in the first row and the oldest version in the last row. The first row in the table is highlighted in bold to indicate that it is the current version in the COMSOL Desktop.

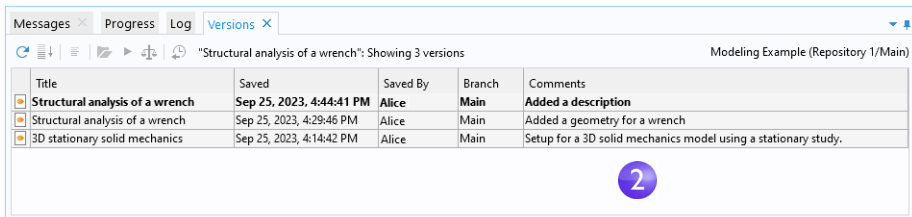

A screenshot of the 'Versions' window. The window title is 'Messages | Progress | Log | Versions'. The main content area shows a table with three rows. The first row is bolded. A purple circle with the number '2' is placed over the table.





Title	Saved	Saved By	Branch	Comments
<b>Structural analysis of a wrench</b>	<b>Sep 25, 2023, 4:44:41 PM</b>	<b>Alice</b>	<b>Main</b>	<b>Added a description</b>
Structural analysis of a wrench	Sep 25, 2023, 4:29:46 PM	Alice	Main	Added a geometry for a wrench
3D stationary solid mechanics	Sep 25, 2023, 4:14:42 PM	Alice	Main	Setup for a 3D solid mechanics model using a stationary study.

## OPENING OLDER VERSIONS

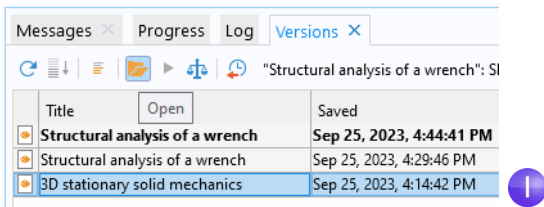
You can easily open an older version from the **Versions** window.

- 1 Select the last row in the table and click the **Open** button  in the toolbar. You can also double-click the row. Select **No** if you are asked to save any unsaved changes.



- The first version is opened in the COMSOL Desktop. In this version, there is no **Import**  node under the **Geometry I**  node, and the **Description** field is empty.
- 2 Select the middle row in the table and click **Open**  .  
The second version is opened in the COMSOL Desktop. In this version, the **Import** node is now present under the **Geometry** node, but the **Description** field is still empty.
  - 3 Select the first row in the table and click **Open**  .  
The third, and latest, version is opened in the COMSOL Desktop.

## Working with a Draft of the Model

---



It may have crossed your mind that saving a new model version requires several steps — especially compared to just pressing Ctrl+S for a model opened from the file system. You need to open the **Save** window, think of a comment describing your changes (although the comment is not required), and then click the **Save** button . You might even realize after saving multiple versions that your modeling work has gone in the wrong direction. You would then have a version history cluttered with unwanted versions.

A more lightweight option when working on a model is to save a draft of the model. You can save multiple versions of this draft without affecting the original model. Once you are happy with your draft, you can save it as a new version of the original model. You may of course choose to discard your draft altogether and instead go back to the original model and, perhaps, start a new draft.

### STARTING A NEW DRAFT



Let's continue working with the wrench model but now using drafts. Make sure that you have opened the latest (first-row) version in the **Versions** window.



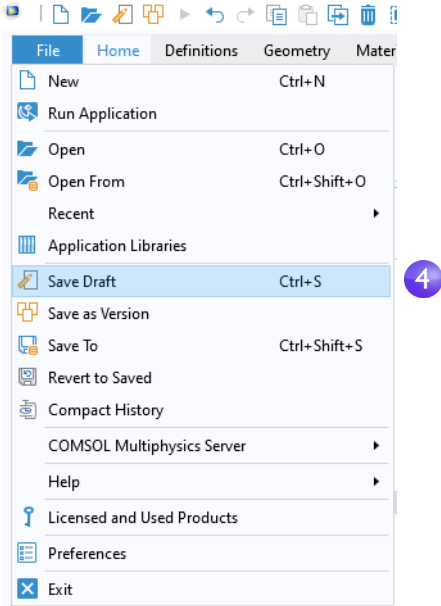

Add a generic steel material for the wrench and save your work as a new draft.

- 1 Right-click **Component 1** > **Materials**  and select **Add Material from Library** .
- 2 In the **Add Material** window, click to expand the **Built-In** folder. Scroll down to find **Structural steel**, right-click, and select **Add to Component 1**.
- 3 Close the **Add Material** window.

4 From the **File** menu, select  **Save Draft**. You can also use the keyboard shortcut Ctrl+S.



You have now created a first version of a draft of the model. You can see this draft version as a new row in the table in the **Versions** window above the three versions of the original model. The draft version uses a separate pen icon (  ) to distinguish it from the regular versions (  ). Note that the regular versions belong to the original model, not the draft itself — they are included in the table to make it easier for you to track where the draft originated from.

Title	Saved	Saved by	Branch	Comments
 Structural analysis of a wrench	Sep 25, 2023, 4:51:29 PM	Alice	Main	Draft of 'Structural analysis of a wrench' saved by user.
 Structural analysis of a wrench	Sep 25, 2023, 4:44:41 PM	Alice	Main	Added a description
 Structural analysis of a wrench	Sep 25, 2023, 4:29:46 PM	Alice	Main	Added a geometry for a wrench
 3D stationary solid mechanics	Sep 25, 2023, 4:14:42 PM	Alice	Main	Setup for a 3D solid mechanics model using a stationary study.

### SAVING ADDITIONAL DRAFT VERSIONS

Just like in “Example 1: Structural Analysis of a Wrench” on page 38, now specify the load applied to the wrench and save your draft changes.





- 1 Select **Parameters** |  $P_1$  in the **Model Builder** window.
- 2 In the **Settings** window's **Parameters** table, enter these settings:
  - In the **Name** column, enter F.
  - In the **Expression** column, enter 150[N].
  - In the **Description** column, enter Applied force.
- 3 From the **File** menu, select  **Save Draft**.

Selecting **Save Draft** a second time creates a second version of your draft — the **Versions** window now contains two draft versions and three regular versions.



Just as for the regular versions of the original model, you can inspect an older draft version by selecting the row in the table and clicking **Open** .

A draft is a model in its own right in the database — existing side-by-side with the original model. You can switch back and forth between them in the COMSOL Desktop simply by opening one or the other.

- 1 From the **File** menu, select **Open From** (  ).
- 2 In the **Open** window, choose your database, Modeling Example, in the list of options.

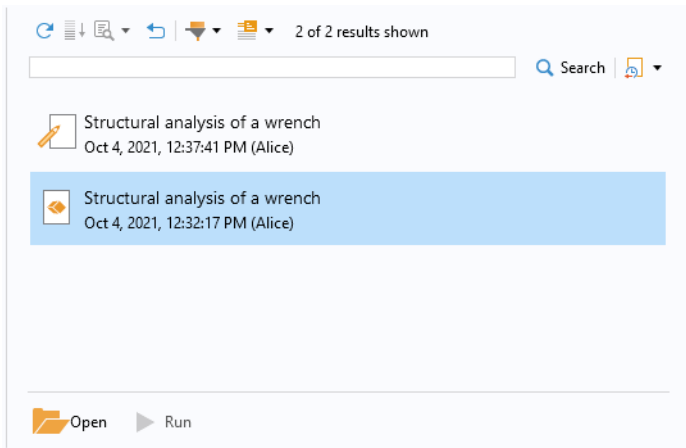
The **Open** window shows a list containing the latest version of the draft (  ) and the latest version of the original model (  ).



- 3 Select the version of the original model (  ) and click the **Open** button .
- The Model Manager detects that there is a draft of the original model in progress that corresponds to a draft version that is newer than the latest version

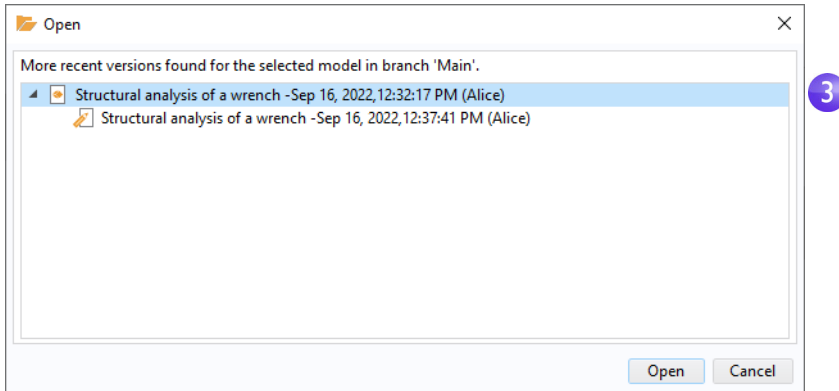

of the model. A dialog box appears, in which you can choose to open that newer draft version instead.





- 4 Select the top node in the tree and click **Open** to open the original model. The latest version of the model is opened in the COMSOL Desktop — neither the **Structural steel** node nor the **Parameters** settings is present in the model, as expected.

You could, at this point, continue working with the original model, thereby implicitly discarding your draft work. The draft itself can be manually deleted from the database at some later time.

Assume that choose to continue with your draft. Open the latest version again:



- 1 From the **File** menu, select **Open From**  .
- 2 In the **Open** window, choose your database in the list of options.
- 3 Select the draft version (  ) and click **Open**  .

Finish the component setup by defining boundary conditions and mesh settings:

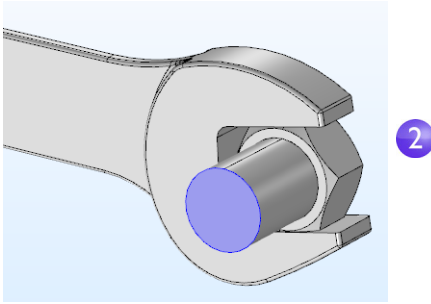

- 1 Right-click **Solid Mechanics (solid)**  and select **Fixed Constraints**  .

- 2 In the **Graphics** window, rotate the geometry and select the front surface of the partially modeled bolt. The **Boundary** number in the **Selection** list is 35.

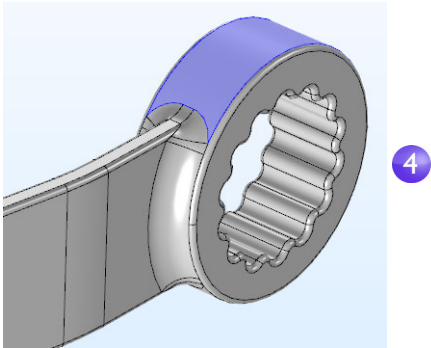

- 3 Right-click **Solid Mechanics (solid)**  once more and select **Boundary Load** .
- 4 Select the top socket face (boundary 111) in the **Graphics** window.



- 5 In the **Settings** window for **Boundary Load**, under **Force**, select **Total force** as the **Load type** and enter  $-F$  in the text field for the **z** component.
- 6 Select **Mesh I** . In the **Settings** window for **Mesh**, under **Physics-Controlled Mesh**, select **Finer** from the **Element size** list.
- 7 Click the **Build All**  button in the **Settings** window.

With the basic setup finished, select **Save Draft**  to save a third draft version.

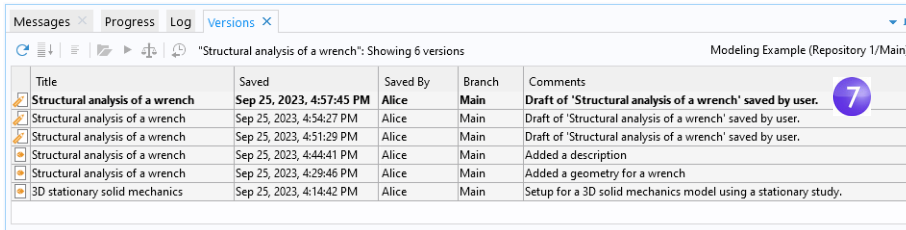

Title	Saved	Saved By	Branch	Comments
Structural analysis of a wrench	Sep 25, 2023, 4:57:45 PM	Alice	Main	Draft of 'Structural analysis of a wrench' saved by user. <b>7</b>
Structural analysis of a wrench	Sep 25, 2023, 4:54:27 PM	Alice	Main	Draft of 'Structural analysis of a wrench' saved by user.
Structural analysis of a wrench	Sep 25, 2023, 4:51:29 PM	Alice	Main	Draft of 'Structural analysis of a wrench' saved by user.
Structural analysis of a wrench	Sep 25, 2023, 4:44:41 PM	Alice	Main	Added a description
Structural analysis of a wrench	Sep 25, 2023, 4:29:46 PM	Alice	Main	Added a geometry for a wrench
3D stationary solid mechanics	Sep 25, 2023, 4:14:42 PM	Alice	Main	Setup for a 3D solid mechanics model using a stationary study.

## FINISHING YOUR DRAFT

With the component setup finished, you can save your draft work back to the original model:

**1** From the **File** menu, select  **Save as Version**.

The **Save** window opens with your database preselected in the list. The header reads **Save version from draft** as a new version of the original model that will be saved from the draft.

**2** Type `Finished model for the von Mises stress in a steel wrench` in the **Comments** field.

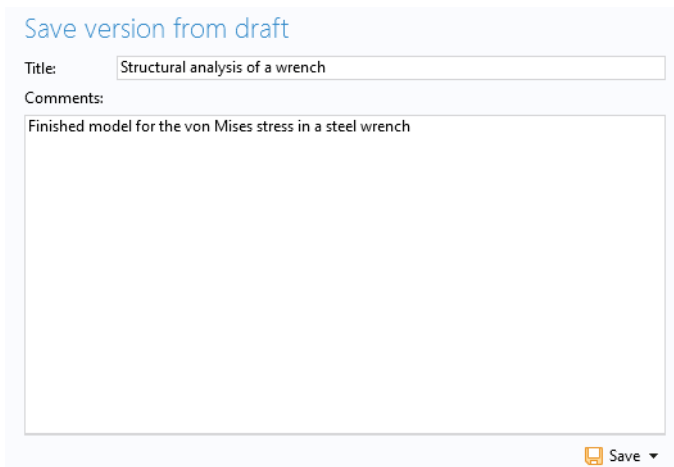

Save version from draft

Title:

Comments:

 Save ▾ **2**

**3** Click the **Save** button .

Open the **Versions** window to see that all draft versions are now gone from the table. Instead, there is a fourth version of the original model and the draft itself has been deleted.

Title	Saved	Saved By	Branch	Comments
<b>Structural analysis of a wrench</b>	<b>Sep 25, 2023, 5:00:24 PM</b>	<b>Alice</b>	<b>Main</b>	<b>Finished model for the von Mises stress in a steel wrench</b>
Structural analysis of a wrench	Sep 25, 2023, 4:44:41 PM	Alice	Main	Added a description
Structural analysis of a wrench	Sep 25, 2023, 4:29:46 PM	Alice	Main	Added a geometry for a wrench
3D stationary solid mechanics	Sep 25, 2023, 4:14:42 PM	Alice	Main	Setup for a 3D solid mechanics model using a stationary study.

# Comparing Versions

You can see all changes made to the model when you save it from your draft.

- 1 Right-click the second row in the table in the **Versions** window and select **Compare** (  ).

The **Comparison Result** window is opened with a comparison between the current model in the COMSOL Desktop and the selected version.

- 2 The expanded tree shows, for example, the force parameter, the steel material, the mesh settings, and the two boundary conditions added from your draft.

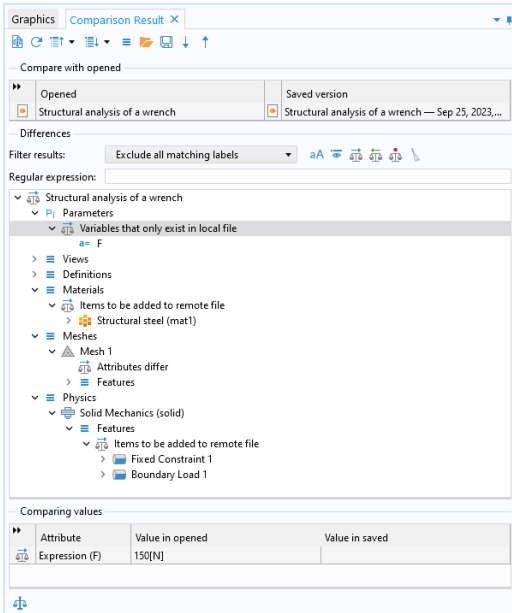

You can also compare two older versions with each other:

- 1 Select the second and third rows in the **Versions** window, using Ctrl+click, then right-click either one, and select **Compare**  .

The **Comparison Result** window is updated with a comparison between these two versions.

- 2 Expand the tree and select the **Attributes differ** child node. In the **Comparing values** table, you will find the description you added in the third model version.

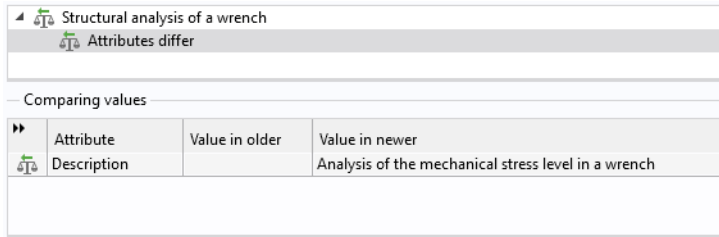



The screenshot shows a software interface with a tree view on the left and a table on the right. The tree view has two nodes: "Structural analysis of a wrench" and "Attributes differ". The "Attributes differ" node is selected. Below the tree view is a section titled "Comparing values". To the right of this section is a blue circle with the number 2. Below the "Comparing values" section is a table with the following content:

Attribute	Value in older	Value in newer
Description		Analysis of the mechanical stress level in a wrench

- 3 Close the **Comparison Result** window.

# Excluding Built, Computed, and Plotted Data

Let's now run the study. First, make sure you have the latest version of the model opened:

- 1 In the **Versions** window, double-click the first row.
- 2 Right-click **Study 1**  and select **Compute**  to solve the model. When the computation finishes after a few seconds, the von Mises stress is displayed in a default **Volume** plot in the **Graphics** window.

Storing simulation data generated by a model can require large amounts of disk space. For such data that is reproducible — such as built, computed, and plotted data — it may be undesirable, or even impossible due to sheer size, to save it in the database. To control which data is saved in the database:

- 1 Select the root node in the **Model Builder** window.
- 2 In the **Settings** window, in the **Save** section under **Built, computed, and plotted data**, in the **In database** list, select **Exclude**.

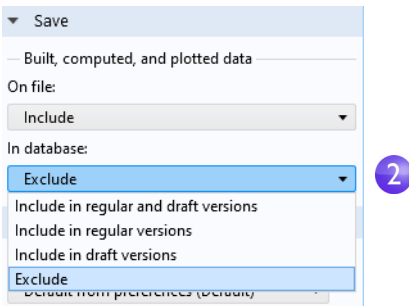

 Note that by using the **On file** list menu, you can also exclude built, computed, and plotted data when saving to the file system.

- 3 From the **File** menu, select  **Save as Version**.

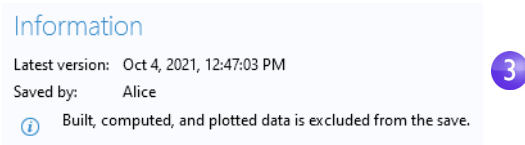

The **Save** window opens for your database with the message **Built, computed, and plotted data is excluded from the save under Information**.



- 4 Type **Saved without generated simulation data.** in the **Comments** field.



5 Click **Save**  .

The model remains in its solved state in the COMSOL Desktop after the save. Go to the **File** menu, select  **Revert to Saved**, and click **Yes** in the dialog box that appears. The latest saved version without the solution is opened. You can reproduce the lost (by now) solution by right-clicking **Study 1**  and selecting **Compute**  .

# Importing Auxiliary Data to the Database

You may have noticed that, while the model is version-controlled in the database, the same is not true for the CAD input file. You can import the file to the database as follows:

- 1 From the **Windows** menu  in the **Layout** section on the **Home** toolbar, select **Auxiliary Data** to open the **Auxiliary Data** window.

The **Auxiliary Data** window shows the input files used in the model. In this case, a single row is shown, corresponding to the CAD file that is used in the **Import**  node.

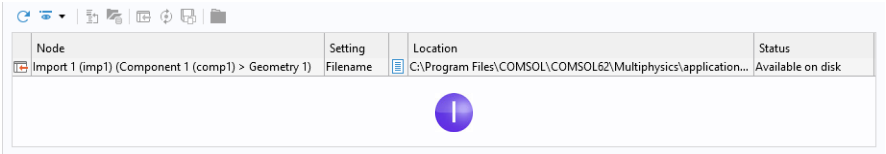

- 2 Select the table row, right-click on either row, and select **Import to Database**  .
- 3 The **Import** dialog box shows the file `wrench.mphbin` in a table.

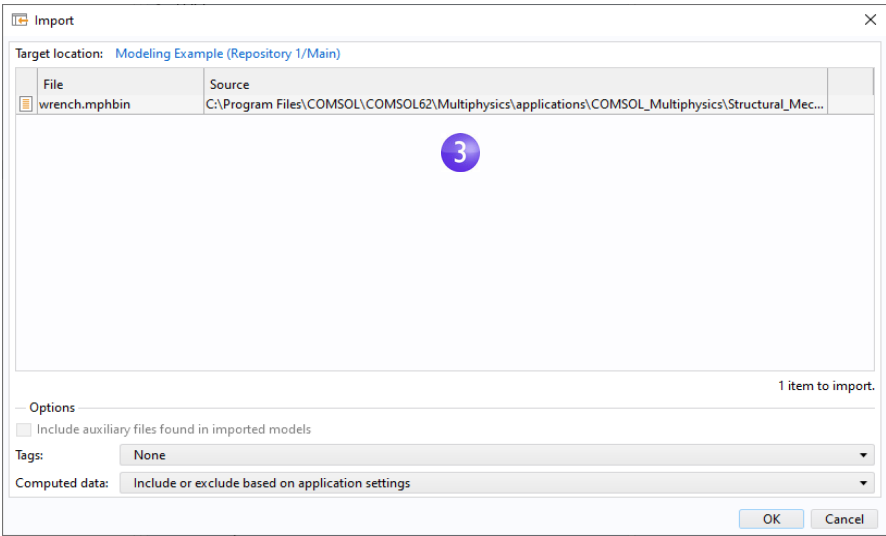

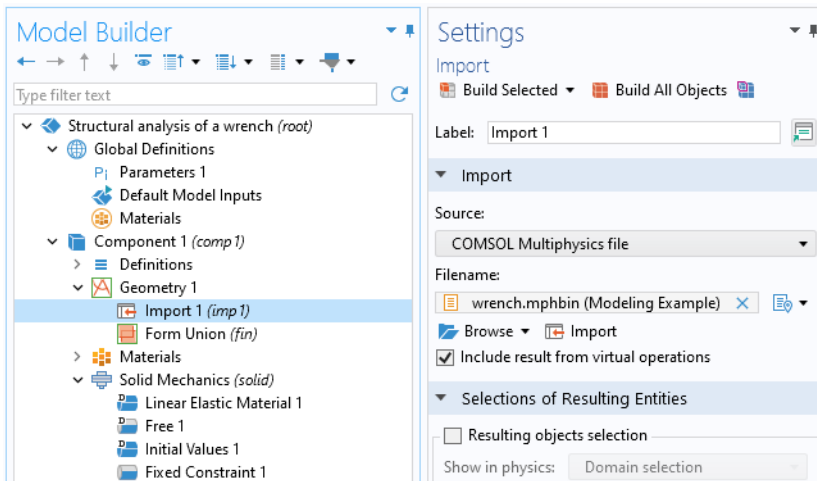

- 4 Click **OK**.

Select the **Import**  node in the **Model Builder** window. The **Filename** field in the **Import** section in the **Settings** window now shows a reference to the file that is uploaded to the database.



Finish by saving the model to the database:

- 1 From the **File** menu, select  **Save as Version**.
- 2 Type Referenced CAD file from database. in the **Comments** field. Click **Save**  .

# The Model Manager Workspace



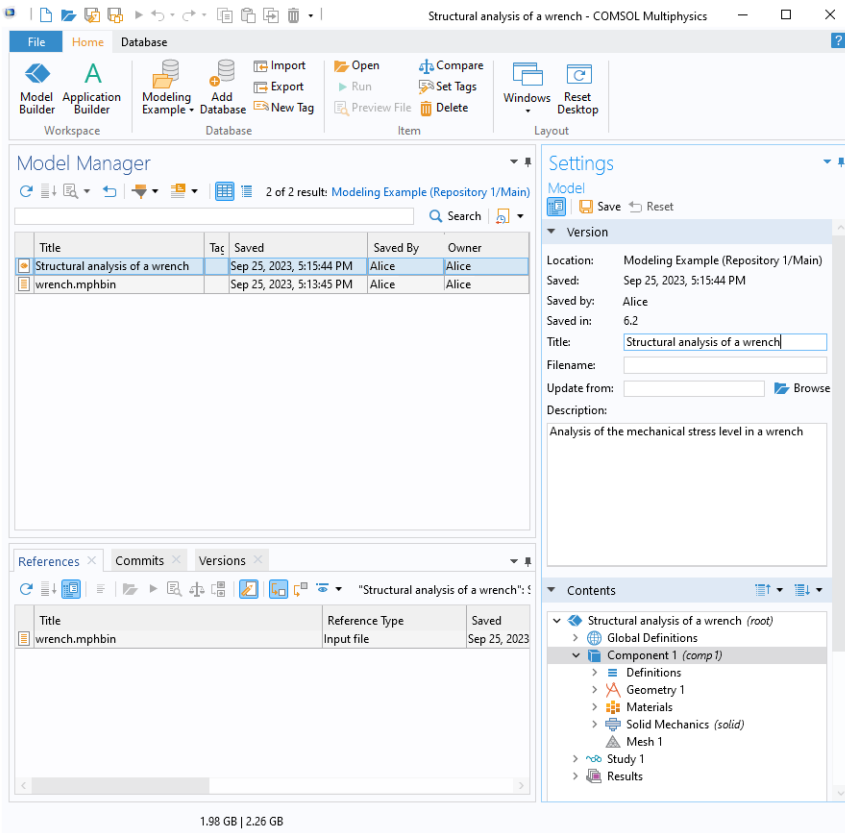

This concludes this quick introduction to the Model Manager. For detailed information on using the Model Manager, see the book *Model Manager Reference Manual*.

You are encouraged to further explore the Model Manager in the Model Manager workspace. This is a dedicated workspace in the COMSOL Desktop for tasks related to using the Model Manager.

To open the Model Manager workspace, click the **Model Manager** button in the **Workspace** section of the **Home** toolbar. In the Model Manager workspace, you will see the Model Manager toolbar as well as various windows belonging to the workspace. The latest versions of your model and CAD file are displayed.



To learn more about what you can do in the workspace, you can, for example:

- Select the model and expand the model tree in the **Content** section of the **Settings** window. Here, you can browse the content of a model without opening it.
- Search for your model by applying various **Item and Contents Filters**. Examples include a **Physics** filter for finding a **Solid Mechanics** interface (  ) or a **Parameter** filter for the applied force 150[N].
- Right-click the model and select **References** (  ) to see the database relationship between the model and the CAD file in the **References** window.
- Right-click the CAD file and select **Versions** (  ) to see all versions of the file — currently only one — in the **Versions** window.
- Right-click the model and select **Commits** (  ) to open the **Commits** window. Double-click the third table row from the top. You will see details on the commit in which a new version of the original model was saved from your draft, and the draft itself was deleted.

In order to more easily test the various features of the Model Manager, you can download a demo database by selecting, from the **File** menu, **Help > Download Demo Database for Model Manager**.

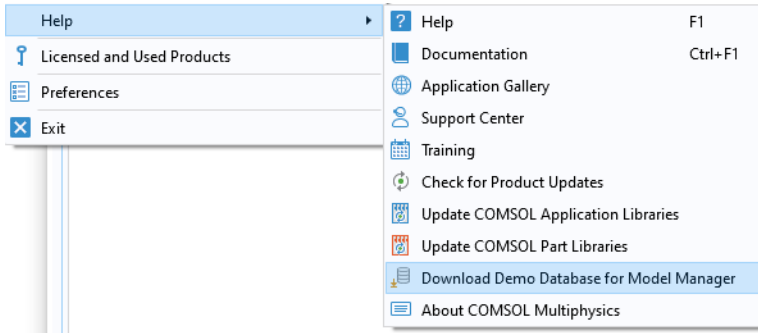

This demo database contains models and associated files from the Application Libraries.

## Appendix A — Building a Geometry

---

This section details how to create the busbar geometry using the built-in geometry tools in COMSOL Multiphysics. The step-by-step instructions take you through the construction of the geometry using the parameters set up in the **Global Definitions** section.



All geometry operations under the geometry node in the model tree are organized in a parametric sequence of operations called a geometry sequence. Using parameterized dimensions helps to produce *what-if* analyses and geometric parametric sweeps.

As an alternative to building the geometry using the tools available in COMSOL Multiphysics, you can import a geometry created with CAD software. The optional CAD Import Module and Design Module support many CAD file formats. Moreover, several add-on products are available that provide bidirectional interfaces to common CAD software packages. See “Appendix E — Connecting with LiveLink™ Add-Ons” on page 263 for a list. Note that the Design Module, in addition to the features available in the CAD Import Module, adds functionality for dimensions and constraints. The Design Module also includes additional 3D geometry modeling operations such as loft, fillet, chamfer, midsurface, and thicken.

If you have not done so already, start with “Example 2: The Busbar — A Multiphysics Model” on page 75. Follow the steps in the section “Model Wizard” on page 39 to add the physics and study and then follow the steps under **Global Definitions** to add the parameters, which are then used in the remainder of this section. Return to this section to learn about geometry modeling.

Alternatively, load the model **busbar\_geom** from the **Application Libraries** tree under **COMSOL Multiphysics > Multiphysics**. Then, in the model tree, right-click the **Geometry** node and select **Clear Sequence**. This deletes all geometry operations from the model tree.

The first step in the geometry sequence is to draw the profile of the busbar.

1 Under **Component 1**, right-click **Geometry 1**  and select **Work Plane** . In the **Settings** window for **Work Plane**:

- Select **xz-plane** from the **Plane** list (the last option in the list).
- Click the **Go to Plane Geometry** button  on the toolbar in the **Settings** window for **Work Plane**.

Continue by editing the axis and grid settings in **Work Plane 1**.

2 In the **Model Builder** window, expand the **View 2** node  and click **Axis** .

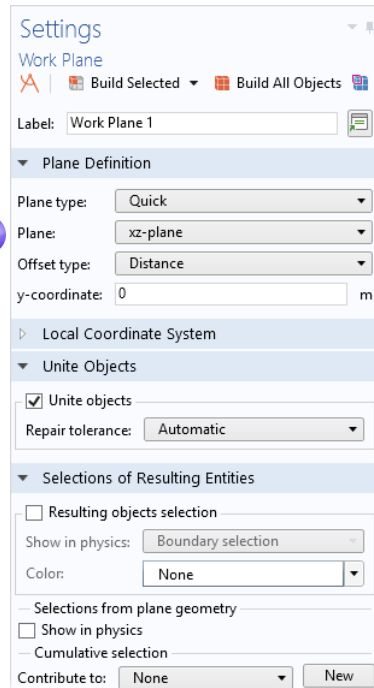
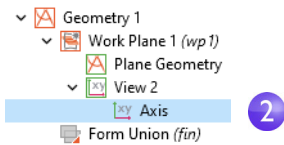

3 In the **Settings** window for **Axis**:

Under **Axis**:

- In the **x minimum** and **y minimum** fields, enter  $-0.01$ .
- In the **x maximum** and **y maximum** fields, enter  $0.11$ .

Under **Grid**:

- Select the **Manual Spacing** check box.
- In the **x spacing** and **y spacing** fields, enter  $5e-3$ .

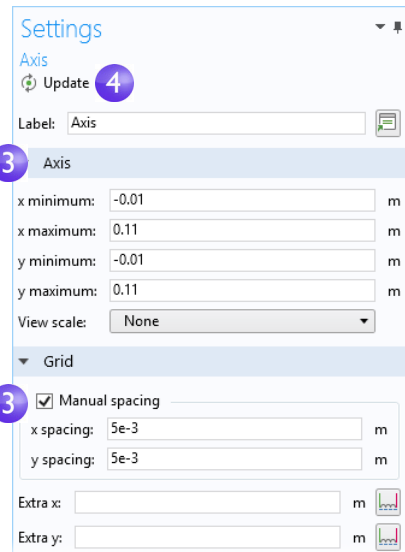

4 Click the **Update** button  on the toolbar.

Note that the values you type will automatically adjust slightly after you click **Update** to adapt to the screen aspect ratio.

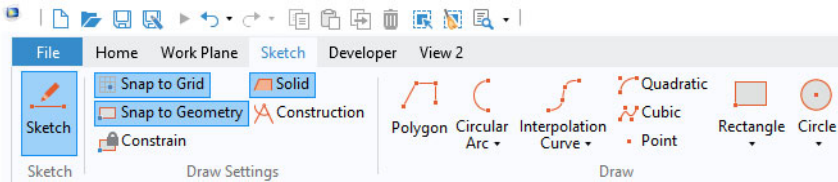

You can use interactive drawing to create a geometry using the drawing tools from the **Sketch** tab on the ribbon while pointing and clicking in the **Graphics** window.



You can also right-click the **Plane Geometry** node  under **Work Plane I**  to add geometry objects to the geometry sequence. Note that you can add geometry objects in the same way from the **Work Plane** tab on the ribbon. For clarity, this example will demonstrate the noninteractive way of creating the geometry (not using the **Sketch** tab).

In the next few steps, we create a profile of the busbar.

**5** In the **Model Builder** window under **Work Plane I**, right-click **Plane Geometry**  and select **Rectangle** .



In the **Settings** window for **Rectangle** under **Size**, enter:

- $L+2*t_{bb}$  in the **Width** field.
- 0.1 in the **Height** field.

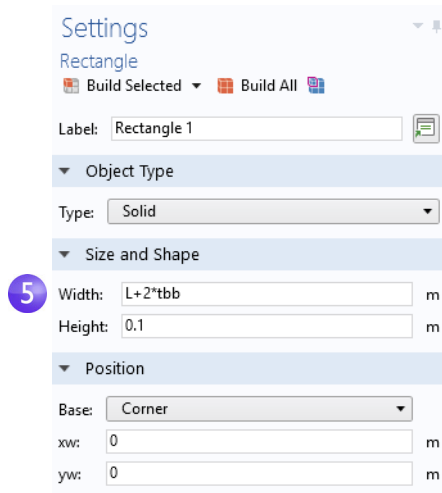
Click the **Build Selected** button .





- 6 Create a second rectangle. Under **Work Plane 1**, right-click **Plane Geometry**  and select **Rectangle** .

Under **Size**, enter:



- $L+tbb$  in the **Width** field.
- $0.1-tbb$  in the **Height** field.

Under **Position**, enter:

- $tbb$  in the **yw** field.

Click the **Build Selected** button .

Use the Boolean **Difference** operation to subtract the second rectangle from the first one.

- 7 Under **Work Plane 1**, right-click **Plane Geometry**  and select **Booleans and Partitions > Difference** .

In the **Graphics** window, click  $r1$  (the larger of the two rectangles) to add it to the **Objects to add** list in the **Settings** window for **Difference**.



To help select the geometry, you can display geometry labels in the **Graphics** window. In the **Model Builder** window under **Geometry 1 > WorkPlane 1**, click the **View 2** node. Go to the **Settings** window for **View** and select the **Show geometry labels** check box.

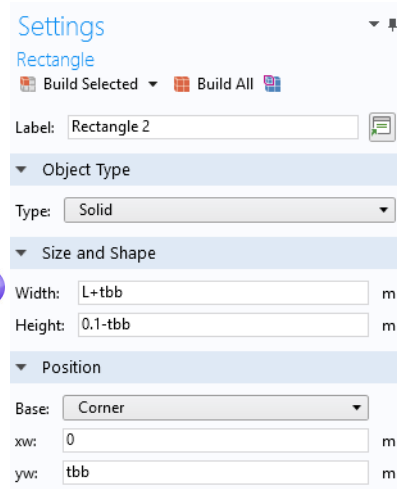

8 Click the **Difference** node. In the **Settings** window for **Difference**, click the **Active selection** button to the left of the **Objects to subtract** list. Select the smaller rectangle,  $r_2$ , by using the mouse scroll wheel or arrow keys to cycle through the overlapping rectangles to first highlight it and then click on it to select it.

Click **Build Selected** .

Another way to select  $r_2$  in the **Graphics** window is to use the **Selection List** feature. Go to the **Home** tab on the ribbon and select **Windows > Selection List**. In the **Selection List**, click to highlight  $r_2$  (solid). Then, right-click  $r_2$  (solid) in the list and select **Add to Objects to Subtract for Difference** to add it to the **Objects to subtract** list.

Right-click on the **Selection List** window title and select **Close**.

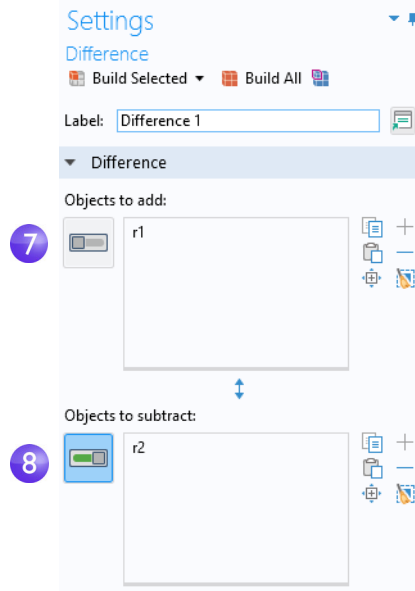

After building the selected geometry, you should have a backward-facing, L-shaped profile. Continue by rounding the corners of the L-shaped profile.

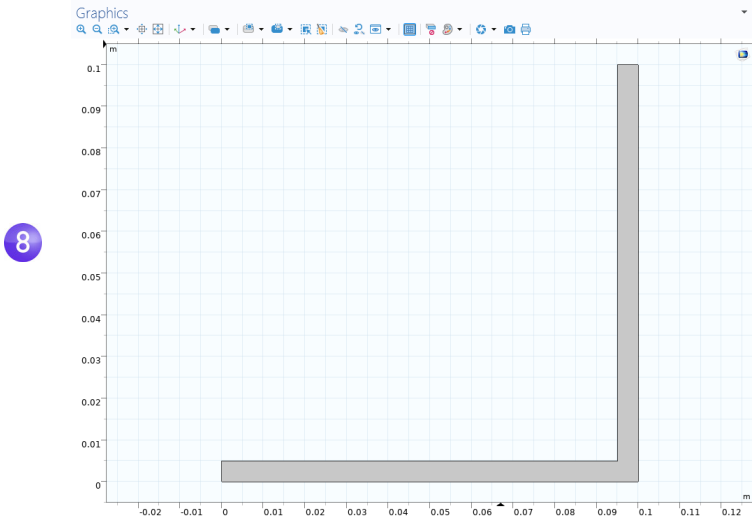

9 Under **Work Plane 1**, right-click **Plane Geometry**  and select **Fillet** .

Select point 3 (in the inner-right corner) to add it to the **Vertices to fillet** list. There are different ways to add points:

- In the **Graphics** window, click point 3 to add it to the **Vertices to fillet** list.
- From the **Home** tab, select **Windows > Selection List**. In the **Selection List** window, click 3. The corresponding point is highlighted in the **Graphics** window. Click the **Add to Active Selection for Fillet** button  in the **Settings** window for **Fillet** or right-click in the **Selection List**.

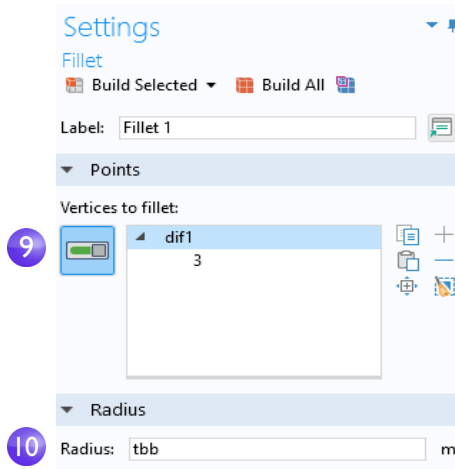

10 Enter **tbb** in the **Radius** field. Click **Build Selected** .

This creates a fillet at the inner corner.

- 11 For the outer corner, right-click **Plane Geometry** and select **Fillet**.
- 12 In the **Graphics** window, click point 6, the outer corner, to add it to the **Vertices to fillet** list.
- 13 Enter  $2*tb$  in the **Radius** field. Click **Build Selected**.

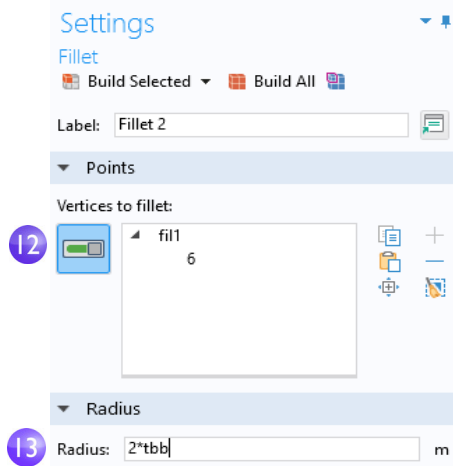

The result should match this figure:

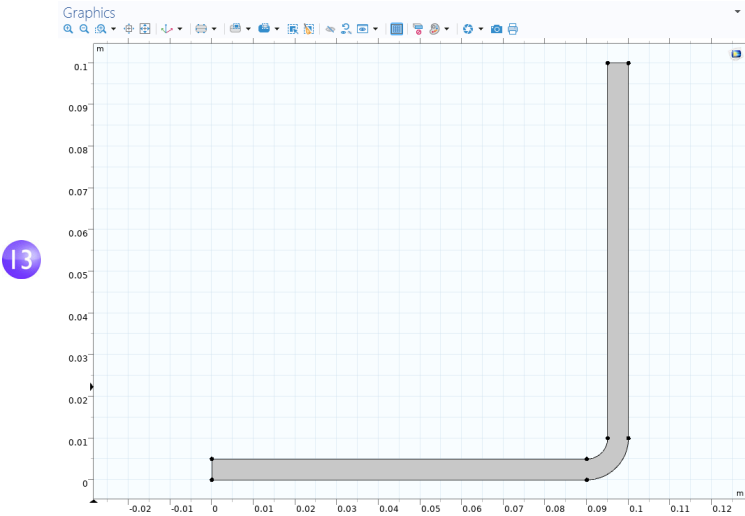

! In the Design Module you will find tools available in the **Sketch** tab for interactive drawing and dimensioning of fillets and general 2D sketches.

Next, extrude the work plane to create the 3D busbar geometry.

- In the **Model Builder** window, right-click **Work Plane 1** and select **Extrude**. In the **Settings** window for **Extrude**, enter `wbb` in the **Distances from Plane** table (replace the default) to extrude to the width of the profile.

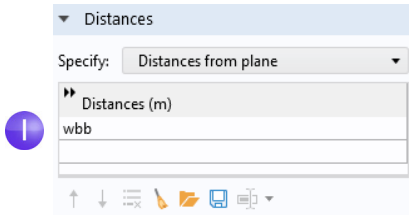

The table allows you to enter several values in order to create sandwich structures with different materials. In this case, only one extruded layer is needed.

- Click **Build Selected** and then click the **Zoom Extents** button on the **Graphics** toolbar. Click the **Save** button and name the model `busbar.mph` (if you have not already done so).

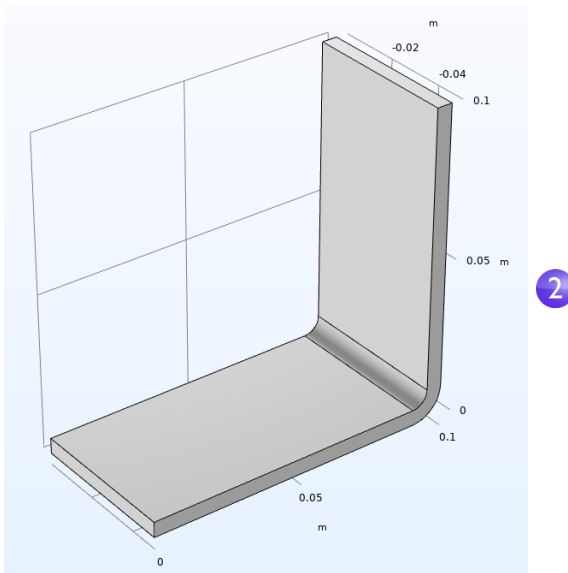

Next, create the titanium bolts by extruding two circles drawn in two work planes.

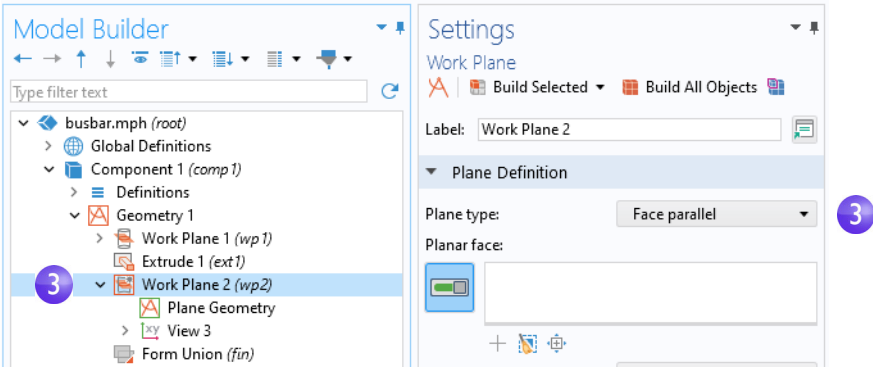

- In the **Model Builder** window, right-click **Geometry 1** and add a **Work Plane**. A **Work Plane 2** node is added. In the **Settings** window for **Work Plane**, under **Plane Definition**, select **Face parallel** as the **Plane type**.

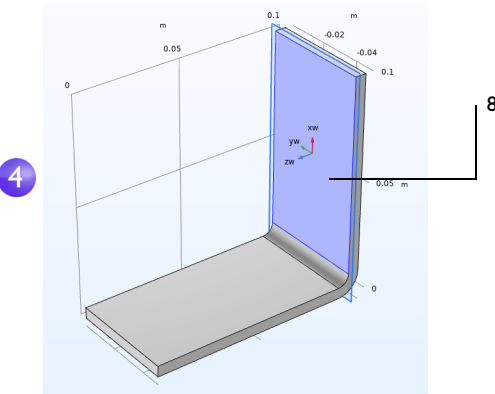

- In the **Graphics** window, click face 8, as shown in the figure below, to add it to the **Planar face** list in the **Settings** window for **Work Plane**. Face 8 is now highlighted in blue and the work plane is positioned on top of the face.



- Click the **Go to Plane Geometry** button to start drawing the first circle representing the position of the first bolt. Click the **Zoom Extents** button on the **Graphics** toolbar.

- 6 Under **Work Plane 2**, right-click **Plane Geometry**  and select **Circle**  .

In the **Settings** window for **Circle**:

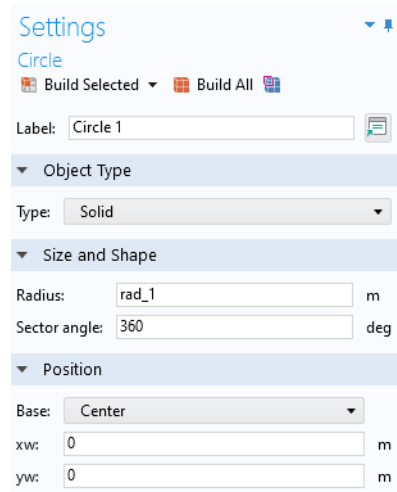

- Under **Size and Shape**, in the **Radius** field, enter `rad_1`.
- Under **Position**, leave the default **xw** and **yw** coordinates (0, 0).

Click **Build Selected**  .



Settings

Circle

 Build Selected  Build All 

Label:  

▼ Object Type

Type:

6 ▼ Size and Shape

Radius:  m

Sector angle:  deg

6 ▼ Position

Base:

xw:  m

yw:  m

Continue creating the bolt by adding an extrude operation.

- In the **Model Builder** window, right-click **Work Plane 2** and select **Extrude**. In the **Settings** window for **Extrude**, in the first row of the **Distances from Plane** table, enter  $-2*tbb$  to extrude the circle.

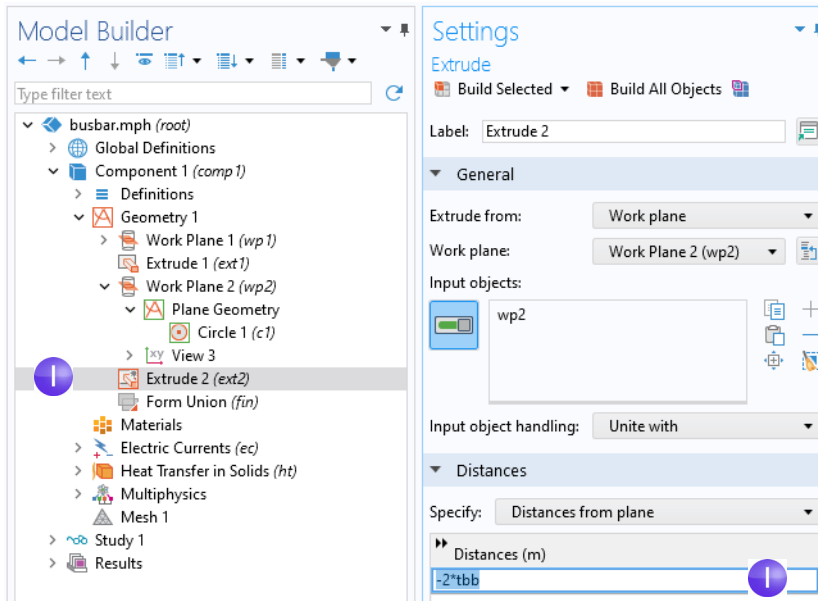

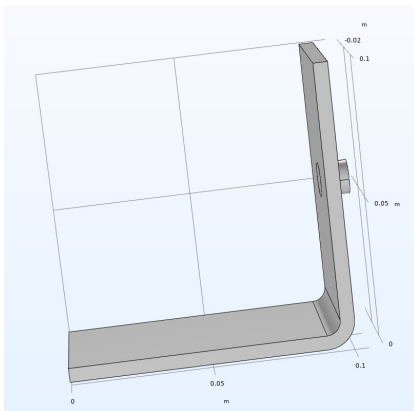

- Click the **Build Selected** button to create the cylindrical part of the titanium bolt that runs through the busbar.





Next, draw the two remaining bolts.

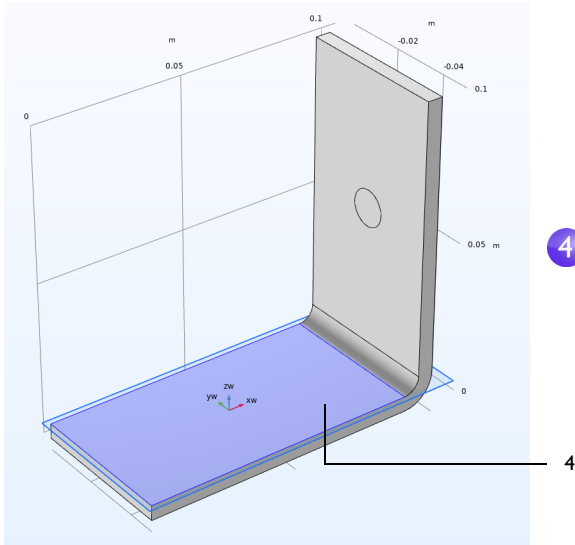

- 3 Right-click **Geometry I**  and select **Work Plane** . A **Work Plane 3** node is added. In the **Settings** window for **Work Plane**, for **Work Plane 3**, select **Face parallel** as the **Plane type**.
- 4 In the **Graphics** window, click face 4, as shown in the figure, to add it to the **Planar face** list in the **Settings** window for **Work Plane**.



- 5 Click the **Show Work Plane** button  on the **Settings** window for **Work Plane** and the **Zoom Extents** button  on the **Graphics** toolbar to get a better view of the geometry.

To parameterize the position of the two remaining bolts, add the circles that form the cross sections of the bolts.



6 Under **Work Plane 3**, right-click **Plane Geometry**  and select **Circle** .

In the **Settings** window for **Circle**:

- Under **Size and Shape**, enter  $rad\_1$  in the **Radius** field.
- Under **Position**, enter  $-L/2+1.5[cm]$  in the **xw** field and  $-wbb/4$  in the **yw** field.

Click **Build Selected** .



Copy the circle that you just created to generate the third bolt in the busbar.

7 Under **Work Plane 3**, right-click **Plane Geometry**  and select **Transforms > Copy** .

8 In the **Graphics** window, click the circle **c1** to select and add the circle to the **Input objects** list in the **Settings** window for **Copy**.

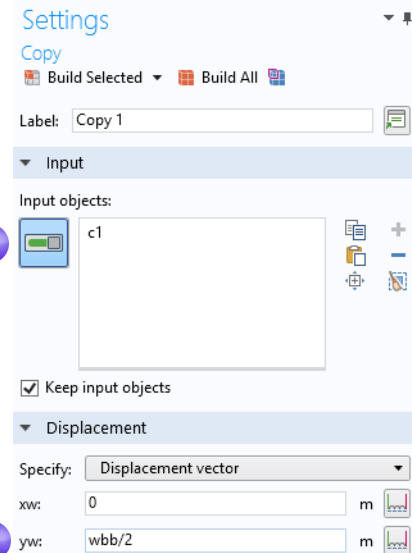
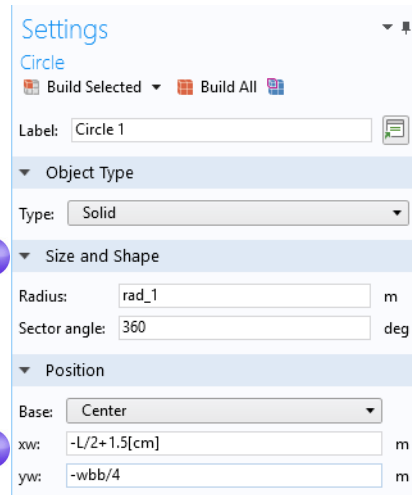
9 In the **Settings** window for **Copy** under **Displacement**, enter  $wbb/2$  in the **yw** field.



10 Click **Build Selected**  and click the **Zoom Extents** button  on the **Graphics** toolbar.

Your geometry, as shown in the work plane, should match this figure so far.

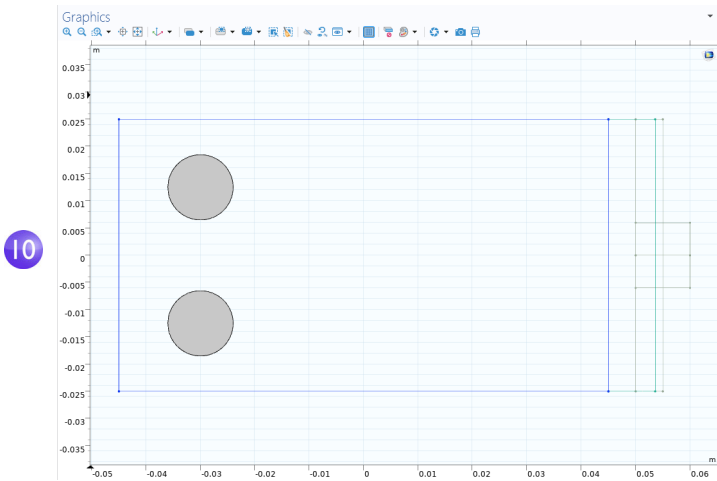

Continue by extruding the circles.

- || In the **Model Builder** window, right-click **Work Plane 3** and select **Extrude**. In the **Settings** window for **Extrude**, in the first row of the **Distances from Plane** table, enter  $-2 \cdot t_{bb}$  (replace the default). Click **Build All Objects**.

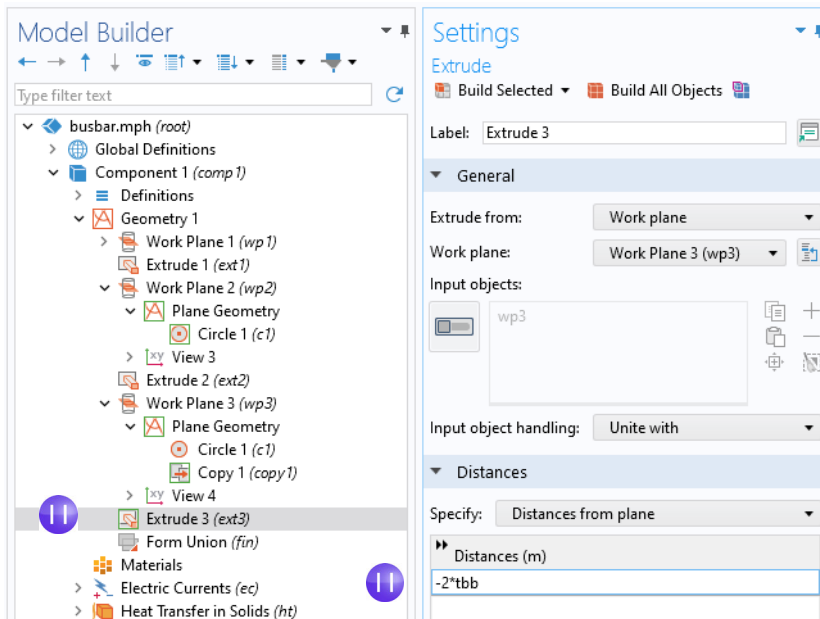

The geometry and geometry sequence should match the figures below. Click the **Save** button and name the model **busbar .mph**.

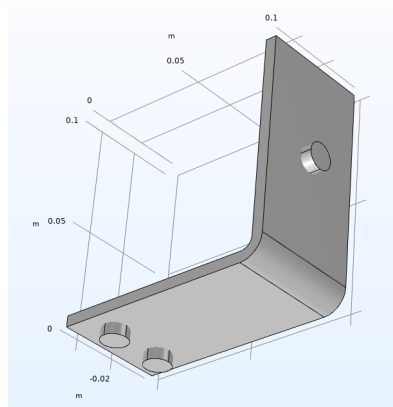
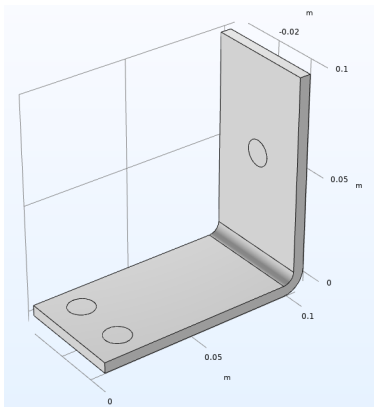

## Creating Parts and Using the Part Libraries

---

After setting up the busbar or other geometry model, it is convenient to be able to save it for future use, hence avoiding unnecessary work. In the steps you have just completed, the geometry was stored directly in the COMSOL model file that will also be used to set up the complete busbar model. Instead, you can also create a reusable and parameterized part that can serve as a building block of a more complex COMSOL model geometry, which is stored in a separate file accessible through the Part Libraries.

While building the busbar geometry, you were using features from the **Geometry** and **Workplane** tabs. A **Parts** ribbon section is located in these tabs.

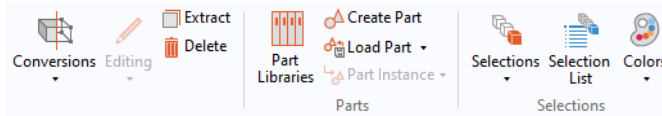

From the **Parts** ribbon section, you can choose to create or load a part, or add a part to the model geometry by selecting one from the **Part Libraries**. Several Part Libraries are already provided with the software by default. When new parts are created, they are added under a part's parent node in the **Global Definitions** section of the model tree. To add a part from a library, you can also right-click the **Geometry** node and select **Parts > Part Libraries**.

The figure below shows an **Internal Helical Gear** part from the part library of the Multibody Dynamics Module. The part comes with 18 **Input Parameters** that control the dimensions.

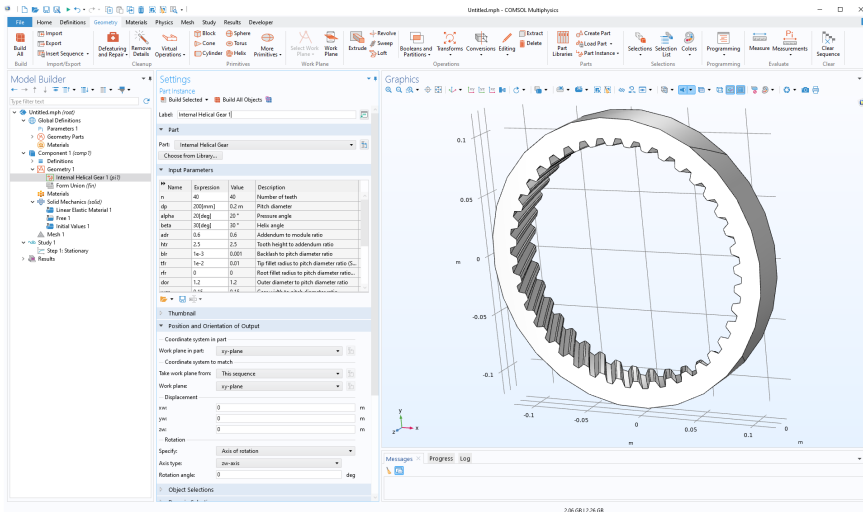

For additional information on working with parts and the Part Libraries, see the *Reference Manual*.



To continue with the busbar tutorial, return to the section “Materials” on page 89.

## Appendix B — Keyboard and Mouse Shortcuts

---

These shortcuts are applicable to the Model Builder, Application Builder, Model Manager, and the Graphics window.

### KEYBOARD SHORTCUTS

SHORTCUT (WINDOWS, LINUX)	SHORTCUT (MACOS)	ACTION
F1 (Fn+F1 on certain tablets)	F1	Open the Help window if needed and display context-sensitive help for the selected node or window.
Ctrl+F1	Command+F1	Open the COMSOL Documentation front page in an external window.
F2	F2	Rename the selected node, file, or folder.
F3	F3	Disable selected nodes.
F4	F4	Enable selected nodes.
F5	F5	Update solution with respect to new definitions without re-solving the model. Update reduced model data. Also, on Windows, to continue in the Method Editor's debugging tool in the Application Builder.
F6	F6	Build the preceding node in the Geometry branch or plot the previous plot for a time-dependent, eigenfrequency, or eigenvalue solution. Also, on Windows, to step in the Method Editor's debugging tool in the Application Builder.

SHORTCUT (WINDOWS, LINUX)	SHORTCUT (MACOS)	ACTION
F7	F7	Build the selected node in the geometry and mesh branches, compute the selected study step, compute the selected node in the solver sequence, or plot the next plot for a time-dependent, eigenfrequency, or eigenvalue solution.  Also, on Windows, to step into in the Method Editor's debugging tool in the Application Builder.
F8	F8	Build the geometry, build the mesh, compute the entire solver sequence, update results data, update the plot, write a report or presentation, or run a method or method call.  Also, on Windows, to create an executable or an add-in in the Application Builder.
F9		On Windows, check syntax for a method in the Application Builder.
Del	Del	Delete selected nodes, objects, or rows in a table.
Escape (Esc)	Escape (Esc)	Cancel ongoing interactive 2D drawing and 3D clipping operations.
Left arrow (Windows); Shift+Left arrow (Linux)	Left arrow	Collapse a branch in the model tree.
Right arrow (Windows); Shift+Right arrow (Linux)	Right arrow	Expand a branch in the model tree.
Up arrow	Up arrow	Move to the node above in the Model Builder. Highlight the next entity for a 3D geometry in the Graphics window when it has focus.
Down arrow	Down arrow	Move to the node below in the Model Builder. Highlight the previous entity for a 3D geometry in the Graphics window when it has focus.



SHORTCUT (WINDOWS, LINUX)	SHORTCUT (MACOS)	ACTION
Alt+numbers	See comment	For the Windows version only: run the corresponding Quick Access Toolbar command if a number is pressed above the character keyboard; otherwise, insert the corresponding ASCII character (requires use of the numeric keypad on Windows). To enter special ASCII characters on macOS, you can change to a specific Unicode Hex Input keyboard layout.
Alt+Left arrow	Ctrl+Left arrow	Move to the previously selected node in the model tree.
Alt+Right arrow	Ctrl+Right arrow	Move to the next selected node in the model tree.
Ctrl+A	Command+A	Select all domains, boundaries, edges, or points; Select all cells in a table.
Ctrl+B	Not available	Enable and remove breakpoint, for use in the Application Builder.
Ctrl+Shift+B	Not available	Enable and disable breakpoint, for use in the Application Builder.
Ctrl+C	Command+C	Copy text in fields. Copy images in graphics and plot windows. Copy tree nodes.
Ctrl+D	Command+D	Clear the selection of all domains, boundaries, edges, or points in the Model Builder. Clear all selections in Form Editor windows.
Ctrl+Shift+D	Command+Shift+D	Duplicate the selected node in the model tree.
Ctrl+F	Command+F	Find a search string.
Ctrl+Shift-F	Command+Shift+F	Find a search string in a method.
Ctrl+G	Command+G	Group nodes.
Ctrl+Shift+G	Command+Shift+G	Ungroup nodes.
Ctrl+K		Create, use, or rename a shortcut to a model tree node (for use in the Application Builder).
Ctrl+L	Command+L	Take a quick image snapshot.

SHORTCUT (WINDOWS, LINUX)	SHORTCUT (MACOS)	ACTION
Ctrl+N	Command+N	New model.
Ctrl+O	Command+O	Open a model file from the file system.
Ctrl+Shift+O	Command+Shift+O	Open a model file from a Model Manager database or file system.
Ctrl+P	Command+P	Print the contents of the plot window.
Ctrl+S	Command+S	Save a model file to the file system.
Ctrl+Shift+S	Command+Shift+S	Save a model file to a Model Manager database or file system.
Ctrl+V	Command+V	Paste copied text or object.
Ctrl+X	Command+X	Cut copied text or object.
Ctrl+Y	Ctrl+Shift+Z	Redo the last undone operation.
Ctrl+Z	Command+Z	Undo the last operation.
Ctrl++		Ctrl key and plus key: Zoom in, in form editors, method editors, and the Main Window editing window, in the Application Builder..
Ctrl+-		Ctrl key and minus key: Zoom in, in form editors, method editors, and the Main Window editing window, in the Application Builder.
Ctrl+0		Reset zoom to 100% in form editors, method editors, and the Main Window editing window, in the Application Builder.
Ctrl+Alt+0		Zoom to fit the available space in form editors and the Main Window editing window, in the Application Builder.
Ctrl+l		Create a local variable or correct the type of an existing variable in methods.
Ctrl+7		Toggle comments on and off in methods.

SHORTCUT (WINDOWS, LINUX)	SHORTCUT (MACOS)	ACTION
Ctrl+Up arrow	Command+Up arrow	Move a definitions node, geometry node, physics node (except default nodes), material node, mesh node, study step node, or results node up one step.
Ctrl+Down arrow	Command+Down arrow	Move a definitions node, geometry node, physics node (except default nodes), material node, mesh node, study step node, or results node down one step.
Ctrl+Space	Ctrl+Space <input type="checkbox"/>	In text fields for expressions: to get access to lists of special operators, variables, prefixes, functions, and other expressions. In methods in the Application Builder: for code completion.
Ctrl+Tab	Ctrl+Tab	Switch focus to the next window on the desktop.
Ctrl+Shift+Tab	Ctrl+Shift+Tab	Switch focus to the previous window on the desktop.
Ctrl+Shift+A		Switch to the Application Builder workspace from the Model Builder or Model Manager.
Ctrl+Shift+J		Switch to the Model Manager workspace from the Model Builder or Application Builder.
Ctrl+Shift+M		Switch to the Model Builder workspace from the Application Builder or Model Manager.
Ctrl+Alt+Left arrow	Command+Alt+Left arrow	Switch focus to the Model Builder window.
Ctrl+Alt+Right arrow	Command+Alt+Right arrow	Switch focus to the Settings window.
Ctrl+Alt+Up arrow	Command+Alt+Up arrow	Switch focus to the previous section in the Settings window.
Ctrl+Alt+Down arrow	Command+Alt+Down arrow	Switch focus to the next section in the Settings window.
Ctrl+F4	Command+W	Close the active window in COMSOL Desktop, if it is closable.

SHORTCUT (WINDOWS, LINUX)	SHORTCUT (MACOS)	ACTION
Ctrl+F8		Test an application.
Ctrl+Alt+Left arrow	Command+Alt+Left arrow	Switch focus to the Model Builder window.
Ctrl+Alt+Right arrow	Command+Alt+Right arrow	Switch focus to the Settings window.
Ctrl+Alt+Up arrow	Command+Alt+Up arrow	Switch focus to the previous section in the Settings window.
Ctrl+Alt+Down arrow	Command+Alt+Down arrow	Switch focus to the next section in the Settings window.
Shift+F10 or (Windows only) Menu key	Ctrl+F10	Open the context menu.
Ctrl+Pause	Command+. (Command + period)	Stop running a method when test running applications.
Ctrl+Space or Ctrl+/ 	Ctrl+Space	Open list of predefined quantities for insertion in Expression fields.
R	R	Toggle between automatic and manual rotation center for mouse rotation in 3D.
+ or - keyboard button, or Up arrow or Down arrow button	+ or - keyboard button, or Up arrow or Down arrow button	Cycle between geometric entities in 3D (domains, boundaries, edges, points) for selection when the focus is in the Graphics window.
+, -	+, -	Highlight the next or previous entity for a 3D geometry in the Graphics window. Expand or collapse a branch in the Model Builder.
Multiply key	Alt+Right arrow	Expand selected part of a tree.
Divide key	Alt+Left arrow	Collapse selected part of a tree.
Shift+Divide key	Alt+Shift+Left arrow	Collapse other parts of a tree.
Page Up or Page Down	Page Up or Page Down	Move up or down in a window in the COMSOL Desktop environment.

## MOUSE SHORTCUTS

SHORTCUT (WINDOWS, LINUX)	SHORTCUT (MACOS)	ACTION
Left-click and hold down the mouse button while dragging the mouse.	Same as for Windows	Rotate the scene around the axes parallel to the screen's x- and y-axes with the origin at the scene rotation point.
Right-click and hold down the mouse button while dragging the mouse.	Same as for Windows	Move the visible frame on the image plane in any direction (pan).
Middle-click and hold down the mouse button while dragging the mouse.	Same as for Windows	The scene is zoomed in/out around the mouse position where the action started.
Press Ctrl and use the scroll wheel.	Same as for Windows	The scene is zoomed in or out around the mouse position where the action started.
Middle-click and use the scroll wheel.	Same as for Windows	The scene is zoomed in/out around the mouse position where the action started with, but with somewhat larger steps.
Press Ctrl and left-click. While holding down the key and button, drag the mouse.	Same as for Windows	Tilt and pan the camera by rotating about the x- and y-axes in the image plane.
Press Ctrl and right-click. While holding down the key and button, drag the mouse.	Same as for Windows	Move the camera in the plane parallel to the image plane.
Press Ctrl and middle-click. While holding down the key and button, drag the mouse.	Same as for Windows	Move the camera into and away from the object (dolly in or out).
Press Ctrl and middle-click.	Same as for Windows	Zoom to the area around the point on the model determined by the mouse position.
Press Ctrl+Alt and left-click. While holding down the keys and button, drag the mouse.	Same as for Windows	Rotate the objects in the scene around the camera look-at direction.
Press Alt and left-click. While holding down the key and button, drag the mouse.	Same as for Windows.	Rotate the objects in the scene around the axis that intersects the camera origin and the scene's rotation center (roll direction).

SHORTCUT (WINDOWS, LINUX)	SHORTCUT (MACOS)	ACTION
Press Alt and right-click. While holding down the key and button, drag the mouse.	Same as for Windows	Move the scene in the plane orthogonal to the axis between the camera and the scene rotation point.
Press Alt and middle-click. While holding down the key and button, drag the mouse.	Same as for Windows	Move the camera along the axis between the camera and the scene rotation point.
Middle-click on model.	Same as for Windows	Set the center of rotation.
Press X, Y, or Z and left-click. While holding down the key and button, drag the mouse.	Same as for Windows	Rotate around the X, Y, or Z-axis, respectively.
R	R	Toggle between manual and automatic rotation center.
+ or - keyboard button, or Up arrow or Down arrow button.	+ or - keyboard button, or Up arrow or Down arrow button	Cycle between 3D geometric entities (domains, boundaries, edges, points) for selection. When focus is in the Graphics window.

## Appendix C — Language Elements and Reserved Names

---

Building a model tree in COMSOL Multiphysics is equivalent to graphically programming a sequence of operations. Using the Record Code functionality in the Application Builder or saving as a model file for MATLAB<sup>®</sup> or Java<sup>®</sup> records and saves the sequence of operations as a list of traditional programming statements. In this section, we will give an overview of the following element categories as defined by the underlying COMSOL language:

- Constants
- Variables
- Functions
- Operators
- Expressions

These language elements are built in or user defined. Operators cannot be user defined. Expressions are always user defined.

### ABOUT RESERVED NAMES

Built-in elements have reserved names, names that cannot be redefined by the user. If you try to use a reserved name for a user-defined variable, parameter, or function, the text where you enter the name will get a yellow squiggly underline and you will get a tooltip message if you hover over the text string. Reserved function names are reserved only for function names, which means that such names can be used for variable and parameter names and vice versa. In the following pages, we list the most commonly used built-in elements and hence those reserved names. A more exhaustive list of built-in elements can be found in the *Programming Reference Manual* and the *Application Programming Guide*.

### VARIABLES USED IN APPLICATIONS

Model parameters and variables can be used in applications. For example, you can let the user of an application change the value of a parameter. In addition, variables to be used in applications can be defined in the Application Builder under the **Declarations** node. Such variables are available globally in form objects and methods but cannot be used in the Model Builder.

## Constants and Parameters

---

There are three different types of constants accessible from the Model Builder: built-in mathematical and numerical constants, built-in physical constants, and parameters. Parameters are user-defined constants, which can vary over parameter sweeps. Constants are scalar valued. The tables below list the built-in mathematical and numerical constants as well as built-in physical constants. Constants and parameters can have units.

### BUILT-IN MATHEMATICAL AND NUMERICAL CONSTANTS

DESCRIPTION	NAME	VALUE
Floating-point relative accuracy for double floating-point numbers, also known as machine epsilon	<code>eps</code>	$2^{-52}$ ( $\sim 2.2204 \cdot 10^{-16}$ )
The imaginary unit	<code>i</code> , <code>j</code>	<code>i</code> , <code>sqrt(-1)</code>
Infinity, $\infty$	<code>inf</code> , <code>Inf</code>	A value larger than what can be handled with floating-point representation
Not-a-number	<code>NaN</code> , <code>nan</code>	An undefined or unrepresentable value, such as the result of <code>0/0</code> or <code>inf/inf</code>
$\pi$	<code>pi</code>	<code>3.141592653589793</code>



## BUILT-IN PHYSICAL CONSTANTS

DESCRIPTION	NAME	VALUE
Acceleration of gravity	<code>g_const</code>	9.80665[m/s <sup>2</sup> ]
Avogadro constant	<code>N_A_const</code>	6.02214076e23[1/mol]
Bohr radius	<code>a0_const</code>	$4 \cdot \pi \cdot \epsilon_{0\_const} \cdot \hbar_{const}^2 / (m_e_{const} \cdot e_{const}^2)$
Boltzmann constant	<code>k_B_const</code>	1.380649e-23[J/K]
Characteristic impedance of vacuum (impedance of free space)	<code>Z0_const</code>	376.73031346177066[ohm]
Electron mass	<code>me_const</code>	9.10938291e-31[kg]
Elementary charge	<code>e_const</code>	1.602176634e-19[C]
Faraday constant	<code>F_const</code>	96485.3365[C/mol]
Fine-structure constant	<code>alpha_const</code>	7.29735298e-3
Gravitational constant	<code>G_const</code>	6.67384e-11[m <sup>3</sup> /(kg*s <sup>2</sup> )]
Molar volume of ideal gas (at 273.15 K and 1 atm)	<code>V_m_const</code>	2.2413968e-2[m <sup>3</sup> /mol]
Neutron mass	<code>mn_const</code>	1.674927351e-27[kg]
Permeability of vacuum (magnetic constant)	<code>mu0_const</code>	$2 \cdot \alpha_{const} \cdot \hbar_{const} / c_{const} / e_{const}$
Permittivity of vacuum (electric constant)	<code>epsilon0_const</code>	$1 / \mu_{0\_const} / c_{const} / c_{const}$
Planck's constant	<code>h_const</code>	6.62607015e-34[J*s]
Planck's constant over 2 pi	<code>hbar_const</code>	1.05457172533629e-34[J*s]
Proton mass	<code>mp_const</code>	1.672621777e-27[kg]
Speed of light in vacuum	<code>c_const</code>	299792458[m/s]
Stefan–Boltzmann constant	<code>sigma_const</code>	5.670373e-8[W/(m <sup>2</sup> *K <sup>4</sup> )]
Universal gas constant	<code>R_const</code>	8.3144621[J/(mol*K)]
Wien's displacement law constant	<code>b_const</code>	2.8977721e-3[m*K]

## PARAMETERS

Parameters are user-defined constant scalars in the **Global Definitions** branch in the model tree. Example uses are:

- Parameterizing geometric dimensions

- Parameterizing mesh element sizes
- Defining parameters to be used in parametric sweeps

A parameter can be defined as an expression in terms of numbers, parameters, built-in constants, and built-in functions of parameters and built-in constants. Parameters should be assigned a unit, using [ ], unless they are dimensionless.

## Variables

---

There are two types of variables used in the Model Builder: built-in variables and user-defined variables. Variables can be scalars or fields. Variables can have units.

Note: Spatial coordinate variables and dependent variables are user-defined variables of special interest. These variables have default names based on the space dimension of the geometry and the physics interface, respectively. As a result of the names chosen for these variables, a list of built-in variables will be created by COMSOL Multiphysics: the first- and second-order derivatives with respect to space and time. The following table contains some of the most important built-in variables. For a complete list, see the *Reference Manual*.

## BUILT-IN VARIABLES

NAME	DESCRIPTION	TYPE
<b>curv</b>	The curvature of a boundary in 2D	Field
<b>curv1, curv2</b>	The principal curvature components of a boundary in 3D	Field
<b>dom</b>	The domain number for a domain, boundary, edge, or point	Field
<b>dvol</b>	Volume scale factor variable; This is the determinant of the Jacobian matrix for the mapping from local (element) coordinates to global coordinates.	Field
<b>freq</b>	Frequency	Global variable
<b>geomapproxdist</b>	For each element, this variable indicates how far a node point in each element was moved from the geometry.	Field
<b>h</b>	Mesh element size (length of the longest edge of the element)	Field
<b>hinscribed</b>	Element inscribed diameter	Field
<b>lambda</b>	Eigenvalue	Global variable
<b>linearizedelem</b>	Elements forced to be linear	Field
<b>numberofdofs</b>	Number of degrees of freedom	Global variable
<b>meshelement</b>	Mesh element number, per type	Field
<b>meshelementall</b>	Mesh element number	Field
<b>meshtype</b>	Mesh type index for the mesh element; This is the number of edges in the element.	Field
<b>meshvol</b>	Volume of the (linearized) element	Field
<b>nx, ny, nz, dnx, dny, dnz, unx, uny, unz</b>	Normal components for the boundary surface normal vector. Down and up normal components in the x-direction are <b>dnx</b> and <b>unx</b> , respectively, and similarly for the y- and z-directions.	Field
<b>phase</b>	Phase angle	Global variable

<code>qual</code> , <code>qualcondition</code> , <code>qualcurvedskewness</code> , <code>qualgrowth</code> , <code>qualmaxangle</code> , <code>qualskewness</code> , <code>qualvollength</code>	Mesh quality measures	Field
<code>realdetjac</code>	The determinant of the Jacobian matrix for the mapping from a straight mesh element to the possibly curved element used when solving. Use this variable to measure the difference in shape between a curved element and the corresponding straight element.	Field
<code>realdetjacmin</code>	A scalar field variable for each element defined as the minimum value of the <code>realdetjac</code> variable for the corresponding element. A <code>realdetjacmin</code> value less than zero for an element means that the element is wrapped inside-out; that is, the element is an inverted mesh element.	Field
<code>s</code> , <code>s1</code> , <code>s2</code>	Curve and surface parameterization variables	Field
<code>t</code>	Time	Global variable
<code>tcurvx</code> , <code>tcurvy</code> , <code>tcurv1x</code> , <code>curv1y</code> , <code>tcurv1z</code> , <code>tcurv2x</code> , <code>tcurv2y</code> , <code>tcurv2z</code>	Tangential directions for the corresponding curvature variables	Field
<code>tx</code> , <code>ty</code> , <code>t1x</code> , <code>t1y</code> , <code>t1z</code> , <code>t2x</code> , <code>t2y</code> , <code>t2z</code>	Tangent vector components corresponding to the curve and surface parameterizations	Field
<code>qual</code>	A mesh quality measure between 0 (poor quality) and 1 (perfect quality)	Field

## USER-DEFINED VARIABLES THAT GENERATE BUILT-IN VARIABLES

DEFAULT NAME	DESCRIPTION	TYPE
<code>x</code> , <code>y</code> , <code>z</code>	Spatial coordinates (Cartesian)	Field
<code>r</code> , <code>phi</code> , <code>z</code>	Spatial coordinates (Cylindrical)	Field
<code>u</code> , <code>T</code> , etc.	Dependent variables (Solution)	Field

Example: `T` is the name for the temperature in a 2D, time-dependent heat transfer model; `x` and `y` are the spatial coordinate names. In this case, the following built-in variables will be generated: `T`, `Tx`, `Ty`, `Txx`, `Txy`, `Tyx`, `Tyy`, `Tt`, `Txt`, `Tyt`, `Txxt`, `Txyt`, `Tyxt`, `Tyyt`, `Ttt`, `Txtt`, `Tytt`, `Txxtt`, `Txytt`, `Tyxtt`, and `Tyytt`. Here, `Tx` corresponds to the partial derivative of the temperature `T` with respect to `x`, `Ttt` corresponds to

the second-order time derivative of  $\tau$ , and so on. If the spatial coordinate variables have other names — for example,  $\psi$  and  $\chi$  — then  $T_{xy}$  would be  $T_{\psi\chi}$ , and  $T_{xt}$  would be  $T_{\psi t}$ . (The time variable  $t$  is built in; the user cannot change its name.)

## Functions

---

In the Model Builder, there are two types of functions: built-in and user-defined. Functions can be scalar valued or field valued depending on the input argument(s). Some functions can have units for both input and output arguments.

### BUILT-IN MATHEMATICAL FUNCTIONS

These functions do not have units for their input or output arguments.

NAME	DESCRIPTION	SYNTAX EXAMPLE
<b>abs</b>	Absolute value	<b>abs(x)</b>
<b>acos</b>	Inverse cosine (in radians)	<b>acos(x)</b>
<b>acosh</b>	Inverse hyperbolic cosine	<b>acosh(x)</b>
<b>acot</b>	Inverse cotangent (in radians)	<b>acot(x)</b>
<b>acoth</b>	Inverse hyperbolic cotangent	<b>acoth(x)</b>
<b>acsc</b>	Inverse cosecant (in radians)	<b>acsc(x)</b>
<b>acsch</b>	Inverse hyperbolic cosecant	<b>acsch(x)</b>
<b>arg</b>	Phase angle (in radians)	<b>arg(x)</b>
<b>asec</b>	Inverse secant (in radians)	<b>asec(x)</b>
<b>asech</b>	Inverse hyperbolic secant	<b>asech(x)</b>
<b>asin</b>	Inverse sine (in radians)	<b>asin(x)</b>
<b>asinh</b>	Inverse hyperbolic sine	<b>asinh(x)</b>
<b>atan</b>	Inverse tangent (in radians)	<b>atan(x)</b>
<b>atan2</b>	Four-quadrant inverse tangent (in radians)	<b>atan2(y, x)</b>
<b>atanh</b>	Inverse hyperbolic tangent	<b>atanh(x)</b>
<b>besselj</b>	Bessel function of the first kind	<b>besselj(a, x)</b>
<b>bessely</b>	Bessel function of the second kind	<b>bessely(a, x)</b>
<b>besseli</b>	Modified Bessel function of the first kind	<b>besseli(a, x)</b>
<b>besselk</b>	Modified Bessel function of the second kind	<b>besselk(a, x)</b>
<b>binomial</b>	Binomial coefficients	<b>binomial(n, k)</b>

NAME	DESCRIPTION	SYNTAX EXAMPLE
<code>ceil</code>	Nearest following integer	<code>ceil(x)</code>
<code>conj</code>	Complex conjugate	<code>conj(x)</code>
<code>cos</code>	Cosine	<code>cos(x)</code>
<code>cosh</code>	Hyperbolic cosine	<code>cosh(x)</code>
<code>cot</code>	Cotangent	<code>cot(x)</code>
<code>coth</code>	Hyperbolic cotangent	<code>coth(x)</code>
<code>csc</code>	Cosecant	<code>csc(x)</code>
<code>csch</code>	Hyperbolic cosecant	<code>csch(x)</code>
<code>erf</code>	Error function	<code>erf(x)</code>
<code>erfinv</code>	Inverse error function	<code>erfinv(x)</code>
<code>exp</code>	Exponential	<code>exp(x)</code>
<code>factorial</code>	Factorial of nonnegative integer	<code>factorial(n)</code>
<code>floor</code>	Nearest previous integer	<code>floor(x)</code>
<code>gamma</code>	Gamma function	<code>gamma(x)</code>
<code>gcd</code>	Greatest common divisor	<code>gcd(a,b)</code>
<code>imag</code>	Imaginary part	<code>imag(u)</code>
<code>lcm</code>	Least common multiple	<code>lcm(a,b)</code>
<code>legendre</code>	Legendre polynomials	<code>legendre(1,x)</code>
<code>legendre</code>	Associated Legendre functions	<code>legendre(1,m,x)</code>
<code>log</code>	Natural logarithm	<code>log(x)</code>
<code>log10</code>	Base-10 logarithm	<code>log10(x)</code>
<code>log2</code>	Base-2 logarithm	<code>log2(x)</code>
<code>max</code>	Maximum of two arguments	<code>max(a,b)</code>
<code>min</code>	Minimum of two arguments	<code>min(a,b)</code>
<code>mod</code>	Modulo operator	<code>mod(a,b)</code>
<code>poweps</code>	Power for use with derivatives of expressions that need to be evaluated near zero	<code>poweps(x,n)</code>
<code>psi</code>	Psi function and its derivatives	<code>psi(x,k)</code>
<code>random</code>	Random function, uniform distribution	<code>random(x,y,...)</code>
<code>randomnormal</code>	Random function, normal distribution	<code>randomnormal(x,y,...)</code>
<code>range</code>	Create a range of numbers	<code>range(a,step,b)</code>
<code>real</code>	Real part	<code>real(u)</code>

NAME	DESCRIPTION	SYNTAX EXAMPLE
<b>round</b>	Round to closest integer	<b>round(x), round(x,p)</b>
<b>sec</b>	Secant	<b>sec(x)</b>
<b>sech</b>	Hyperbolic secant	<b>sech(x)</b>
<b>sign</b>	Signum function	<b>sign(u)</b>
<b>sin</b>	Sine	<b>sin(x)</b>
<b>sinh</b>	Hyperbolic sine	<b>sinh(x)</b>
<b>sphericaly</b>	Spherical harmonic function	<b>sphericaly(l,m,theta,phi)</b>
<b>sphericalyr</b>	Real spherical harmonic function	<b>sphericalyr(l,m,theta,phi)</b>
<b>sqrt</b>	Square root	<b>sqrt(x)</b>
<b>sqrteps</b>	Square root for use with expressions that need to be evaluated near zero	<b>sqrteps(x)</b>
<b>tan</b>	Tangent	<b>tan(x)</b>
<b>tanh</b>	Hyperbolic tangent	<b>tanh(x)</b>
<b>zernike</b>	Zernike polynomials	<b>zernike(n,m,r,phi)</b>

## BUILT-IN OPERATOR FUNCTIONS

These built-in functions behave differently than the built-in mathematical functions. They may not belong in an introductory text but are listed to complete the list of reserved names. For more information, see the *Reference Manual*.

NAME	NAME	NAME	NAME
adj	depends	lintotal	side
at	dest	lintotalavg	sphavg
atlocal	dflux	lintotalpeak	sphint
atonly	diskavg	lintotalrms	stddev
at0	diskint	linzero	subst
at1	down	mean	substval
at2	dtang	nif	sum
at3	elemavg	nojac	test
atent0	elemgpmx	noenv	timeavg
atent1	elemgpmin	novar	timeint
atent2	elemint	nox	timemax
atent3	emetric	patcheval	timemin
atpmax	env	pd	treatasconst
atpmin	error	pint	try_catch
attimemax	frame.dt	pmax	uflux
attimemin	fsens	pmin	up
atxd	fsensimag	ppr	var
atxd0	gpeval	pprint	with
atxd1	if	prev	withparam
atxd2	integrate	psum	withsol
atxd3	isdefined	reactf	
ballavg	islinear	realdot	
ballint	isnan	residual	
bdf	jacdepends	scope.atenti	
bndenv	laginterp	scope.ati	
centroid	lindev	sens	
circavg	linper	setconst	
circint	linpoint	setind	
circumcenter	isinf	setval	
d	linsol	shapeorder	

## USER-DEFINED FUNCTIONS

A user-defined function can be defined in the model tree under the **Global Definitions** node or, for each **Component**, under the **Definitions** node. Select a



template from the **Functions** menu and enter settings to define the name and detailed shape of the function.

TEMPLATE NAME	ARGUMENTS AND DEFINITION	SYNTAX EXAMPLE
Analytic	<p>The function name is its identifier; for example, <b>an1</b>.</p> <p>The function is a mathematical expression of its arguments.</p> <p>Example: Given the arguments <b>x</b> and <b>y</b>, its definition is <b>sin(x)*cos(y)</b>.</p> <p>The function has an arbitrary number of arguments.</p>	<p>The name of the function with comma-separated arguments within parentheses. For example:</p> <p><b>an1(x,y)</b></p>
Interpolation	<p>The function name is its identifier; for example, <b>int1</b>.</p> <p>An interpolation function is defined by a table or file containing the values of the function in discrete points.</p> <p>The file formats are the following: spreadsheet, grid, or sectionwise.</p> <p>The function has one to three arguments.</p>	<p>The name of the function with comma-separated arguments within parentheses. For example:</p> <p><b>int1(x,y,z)</b></p>
Piecewise	<p>The function name is its identifier; for example, <b>pw1</b>.</p> <p>A piecewise function is created by splicing together several functions, each defined on one interval. Define the argument, extrapolation and smoothing methods, and the functions and their intervals.</p> <p>This function has one argument with different definitions on different intervals, which must not overlap or have any holes between them.</p>	<p>The name of the function with a single argument within parentheses. For example:</p> <p><b>pw1(x)</b></p>

TEMPLATE NAME	ARGUMENTS AND DEFINITION	SYNTAX EXAMPLE
Gaussian Pulse	<p>The function name is its identifier; for example, <b>gp1</b>.</p> <p>The Gaussian pulse function defines a bell-shaped curve according to the expression</p> $y(x) = \frac{1}{\sigma\sqrt{2\pi}} e^{-\frac{(x-x_0)^2}{2\sigma^2}}$ <p>It is defined by the mean parameter, <math>x_0</math>, and the standard deviation, <math>\sigma</math>.</p> <p>The function has one argument.</p>	<p>The name of the function with a single argument within parentheses. For example:</p> <p><b>gp1(x)</b></p>
Ramp	<p>The function name is its identifier; for example, <b>rm1</b>.</p> <p>A ramp function is a linear increase with a user-defined slope that begins at some specified time.</p> <p>The function has one argument. It can also be smoothed.</p>	<p>The name of the function with a single argument within parentheses. For example:</p> <p><b>rm1(x)</b></p>
Rectangle	<p>The function name is its identifier; for example, <b>rect1</b>.</p> <p>A rectangle function is <b>1</b> in an interval and <b>0</b> everywhere else.</p> <p>The function has one argument.</p>	<p>The name of the function with a single argument within parentheses. For example:</p> <p><b>rect1(x)</b></p>
Step	<p>The function name is its identifier; for example, <b>step1</b>.</p> <p>A step function is a sharp transition from <b>0</b> to some other value (amplitude) at some location.</p> <p>The function has one argument. It can also be smoothed.</p>	<p>The name of the function with a single argument within parentheses. For example:</p> <p><b>step1(x)</b></p>
Triangle	<p>The function name is its identifier; for example, <b>tri1</b>.</p> <p>A triangle function is a linear increase and linear decline within an interval and <b>0</b> everywhere else.</p> <p>The function has one argument. It can also be smoothed.</p>	<p>The name of the function with a single argument within parentheses. For example:</p> <p><b>tri1(x)</b></p>

TEMPLATE NAME	ARGUMENTS AND DEFINITION	SYNTAX EXAMPLE
Waveform	<p>The function name is its identifier; for example, <b>wv1</b>.</p> <p>A waveform function is a periodic function with one of several characteristic shapes: sawtooth, sine, square, or triangle.</p> <p>The function has one argument. It can also be smoothed.</p>	<p>The name of the function with a single argument within parentheses. For example:</p> <p><b>wv1(x)</b></p>
Normal Distribution	<p>The function name is its identifier; for example, <b>nd1</b>.</p> <p>Defines the probability density function, cumulative distribution function, and quantile function for a normal distribution.</p>	<p>The name of the function with a single argument within parentheses. For example:</p> <p><b>nd1(x)</b>, <b>nd1_cum(x)</b>, and <b>nd1_cum_inv(x)</b></p>
Random	<p>The function name is its identifier; for example, <b>rn1</b>.</p> <p>A random function generates white noise with uniform or normal distribution and has one or more arguments for simulating white noise.</p> <p>The function has arbitrary number of arguments.</p>	<p>The name of the function with comma-separated arguments within parentheses. For example:</p> <p><b>rn1(x,y)</b></p> <p>The arguments x and y are used as random seeds for the random function.</p>
External (Global Definitions only)	<p>An external function defines an interface to one or more functions written in the C language (which can be a wrapper function interfacing source code written in, for example, Fortran). Such an external function can be used, for example, to interface a user-created shared library. Note that the extension of a shared library file depends on the platform: .dll (Windows), .so (Linux), or .dylib (macOS).</p>	<p>The name of the function and the appropriate number of arguments within parentheses. For example:</p> <p><b>myextfunc(a,b)</b></p>

TEMPLATE NAME	ARGUMENTS AND DEFINITION	SYNTAX EXAMPLE
MATLAB® (Global Definitions only)	A MATLAB® function interfaces with one or more functions written in the MATLAB® language. Such functions can be used as any other function defined in COMSOL Multiphysics®, provided that LiveLink™ for MATLAB® and MATLAB® are installed. (MATLAB® functions are evaluated by MATLAB® at runtime.)	The name of the function and the appropriate number of arguments within parentheses. For example: <b>my matlabfunc (a, b)</b>
Elevation	The function name is its identifier, for example, <b>elev1</b> . Used to import geospatial elevation data from digital elevation models and map the elevation data to a function of <b>x</b> and <b>y</b> . A DEM file contains elevation data for a portion of the Earth's surface. The resulting function behaves essentially like a grid-based interpolation function.	The name of the function with comma-separated arguments within parentheses. For example: <b>elev1 (x, y)</b>
Image	The function name is its identifier, for example, <b>im1</b> . Used to import an image (in BMP, JPEG, PNG, or GIF format) and map the image's RGB data to a scalar (single-channel) function output value. By default, the function's output uses the mapping (R+G+B)/3.	The name of the function with comma-separated arguments within parentheses. For example: <b>im1 (x, y)</b>
Least-Squares Fit	The function name is its identifier, for example, <b>lsq1_fun1</b> . Used for least-squares function approximation. Defines a least-squares fit of one or more parameterized functions with respect to the input data. The input data can be a file, a local table, or a results table.	The name of the function with comma-separated arguments within parentheses. For example: <b>lsq1_fun1 (x1, x2)</b>

TEMPLATE NAME	ARGUMENTS AND DEFINITION	SYNTAX EXAMPLE
Gaussian Process	<p>The function name is its identifier, for example, <b>gpm1</b>.</p> <p>Used for multidimensional interpolation and surrogate model training. Defines one or more functions trained on input data through a Gaussian process regression method. The input data can be a file or a result table.</p> <p>Note: Training a <b>Gaussian Process</b> function requires the Uncertainty Quantification Module. Using a model that already contains a trained <b>Gaussian Process</b> function does not require any add-on products.</p>	<p>The name of the function with comma-separated arguments within parentheses. For example:</p> <p><b>gpm1 (x1 , x2)</b></p>
Polynomial Chaos Expansion	<p>The function name is its identifier, for example, <b>pce1</b>.</p> <p>Used for multidimensional interpolation and surrogate model training. Defines one or more functions trained on input data through a Polynomial Chaos Expansion method. The input data can be a file or a result table.</p> <p>Note: Training a <b>Polynomial Chaos Expansion</b> function requires the Uncertainty Quantification Module. Using a model that already contains a trained <b>Polynomial Chaos Expansion</b> function does not require any add-on products.</p>	<p>The name of the function with comma-separated arguments within parentheses. For example:</p> <p><b>pce1 (x1 , x2)</b></p>
Deep Neural Network	<p>The function name is its identifier, for example, <b>dnn1</b>.</p> <p>Used for multidimensional interpolation and surrogate model training. Defines one or more functions trained on input data through a <b>Deep Neural Network</b> method. The input data can be a file or a result table.</p>	<p>The name of the function with comma-separated arguments within parentheses. For example:</p> <p><b>dnn1 (x1 , x2)</b></p>

TEMPLATE NAME	ARGUMENTS AND DEFINITION	SYNTAX EXAMPLE
Partial Fraction Fit	<p>The function name is its identifier, for example, <b>pff1</b>.</p> <p>Used for rational approximation of frequency-domain responses. This approximation makes it possible to compute its inverse Fourier transform analytically and thus obtain the time-domain impulse response function.</p> <p>The input data can be a file or a result table. The output is complex valued.</p>	<p>The name of the function with a single argument within parentheses. For example:</p> <p><b>pff1 (x)</b></p>
Function Switch	<p>The function name is its identifier, for example, <b>sw1</b>.</p> <p>A switch is used to switch between global functions during a solver sweep. You add the functions as subnodes under the <b>Switch</b> node. The switch for functions acts essentially as a switch statement in a programming language; that is, it dynamically chooses one of its underlying branches depending on a parameter that can be controlled from the solvers using a <b>Function Sweep</b> study. You can also add a <b>Switch</b> node under <b>Materials</b> and then use a <b>Material Sweep</b> to sweep over a discrete set of materials.</p>	<p>Switch is a container node for functions.</p>

## Unary and Binary Operators

In the Model Builder, the following table contains the unary and binary operators that can be used in expressions.

PRECEDENCE LEVEL	SYMBOL	DESCRIPTION
1	( ) { } .	Grouping, Lists, Scope
2	^	Power
3	! - +	Unary: Logical NOT, Minus, Plus

PRECEDENCE LEVEL	SYMBOL	DESCRIPTION
4	[ ]	Unit
5	* /	Multiplication, Division
6	+ -	Binary: Addition, Subtraction
7	< <= > >=	Comparisons: Less-Than, Less-Than or Equal, More-Than, More-Than or Equal
8	== !=	Comparisons: Equal, Not Equal
9	&&	Logical AND
10		Logical OR
11	,	Element Separator in Lists

## Expressions

---

### PARAMETERS

A parameter expression can contain: numbers, parameters, built-in constants, built-in functions of parameter expressions, and unary and binary operators. Parameters can have units.

### VARIABLES

A variable expression can contain: numbers, parameters, constants, variables, functions of variable expressions, and unary and binary operators. Variables can have units.

### FUNCTIONS

A function definition can contain: input arguments, numbers, parameters, constants, functions of parameter expressions, including input arguments, unary and binary operators.

## Appendix D — File Formats

---

### COMSOL File Formats

---

The COMSOL Model MPH-file type, with the extension `.mph`, is the default file type containing the entire model tree and application tree from the Model Builder and Application Builder, respectively. The file contains both binary and text data. The mesh and solution data is stored as binary data, while all other information is stored as plain text.

The COMSOL binary and text file types, with the extension `.mphbin` and `.mphtxt`, respectively, contain either geometry objects or mesh objects that can be imported directly to the **Geometry** or **Mesh** nodes in the model tree. Note that if the CAD Import Module, Design Module, or one of the LiveLink™ add-on products for CAD was used to create a geometry model, then the same product may be required to open the corresponding file. This is because the geometry model may require features that are only available in one of the add-on products.

The Physics Builder file type, with the extension `.mphphb`, contains one or more user-defined physics interfaces that you can access from the Model Builder. See the *Physics Builder Manual* for more information.

See [Supported External File Formats](#) for more information about all the other formats supported by COMSOL Multiphysics.

FILE TYPE	EXTENSION	READ	WRITE
COMSOL Model and Application	<code>.mph</code>	Yes	Yes
COMSOL Binary Data	<code>.mphbin</code>	Yes	Yes
Physics Builder	<code>.mphphb</code>	Yes	Yes
COMSOL Text Data	<code>.mphtxt</code>	Yes	Yes

### Supported External File Formats

---

#### CAD

The CAD Import Module and Design Module allow for the import of a range of industry-standard CAD file types. Additional file types are available through the



bidirectional functionality of the LiveLink products for CAD as well as with the File Import for CATIA® V5 add-on.

The DXF (2D), VRML (3D), STL (3D), PLY (3D), and 3MF (3D) file types are available for import with COMSOL Multiphysics and do not require any add-on products. Unless noted otherwise in the table below, import of the listed file types is available on all supported versions of Linux®, macOS, and Windows® operating systems.

FILE TYPE	EXTENSION	READ	WRITE
AutoCAD® <sup>1,2,3</sup>	.dwg	Yes	Yes <sup>9</sup>
Inventor® <sup>1,2,3</sup>	.ipt, .iam	Yes	Yes <sup>9</sup>
NX® <sup>1,4</sup>	.prt	Yes	No
PTC® Creo® Parametric™ <sup>1,3</sup>	.prt, .asm	Yes	Yes <sup>9</sup>
Revit® <sup>3,5</sup>	.rvt	Yes <sup>9</sup>	Yes <sup>9</sup>
Solid Edge® <sup>3,6</sup>	.par, .asm	Yes <sup>9</sup>	Yes <sup>9</sup>
SOLIDWORKS® <sup>1,2,3</sup>	.sldprt, .sldasm	Yes	Yes <sup>9</sup>
DXF (3D <sup>1,2</sup> and 2D)	.dxf	Yes	Yes <sup>10</sup>
Parasolid® <sup>1</sup>	.x_t, .xmt_txt, .x_b, .xmt_bin	Yes	Yes
ACIS® <sup>1</sup>	.sat, .sab, .asat, .asab	Yes	Yes
STEP <sup>1</sup>	.step, .stp	Yes	Yes
IGES <sup>1</sup>	.iges, .igs	Yes	Yes
CATIA® V5 <sup>2,7</sup>	.CATPart, .CATProduct	Yes	No
VRML, v1 <sup>8</sup>	.vrml, .wr1	Yes	No
STL	.stl	Yes	Yes
3MF	.3mf	Yes	No

FILE TYPE	EXTENSION	READ	WRITE
PLY	.ply	Yes	No

<sup>1</sup> Requires one of the LiveLink™ products for AutoCAD®, Revit®, PTC® Creo® Parametric™, Inventor®, Solid Edge®, SOLIDWORKS®, the CAD Import Module, or the Design Module

<sup>2</sup> Import supported on Windows® operating systems only

<sup>3</sup> Synchronization of files between COMSOL Multiphysics and a linked CAD program supported on Windows® operating systems only

<sup>4</sup> Import supported on Windows® and Linux operating systems only

<sup>5</sup> Requires LiveLink™ for Revit®

<sup>6</sup> Requires LiveLink™ for Solid Edge®

<sup>7</sup> Requires the CAD Import Module (or the Design Module or one of the LiveLink™ products for AutoCAD®, PTC® Creo® Parametric™, Inventor®, Solid Edge®, or SOLIDWORKS®) and the File Import for CATIA® V5

<sup>8</sup> Limited to a single geometric domain

<sup>9</sup> From/To file using linked CAD package, provided the original CAD geometry is created in the CAD package

<sup>10</sup> Writing to file is supported for 2D geometry only

## ECAD

The ECAD Import Module allows for import of 2D layout files with automatic conversion to 3D CAD models. The Touchstone file type is used for exporting S-parameters, impedance, and admittance values from simultaneous port and frequency sweeps. The SPICE Circuit Netlist file type is converted at import to a series of lumped circuit element nodes under an **Electrical Circuit** node.

FILE TYPE	EXTENSION	READ	WRITE
IPC-2581 <sup>1</sup>	.cvg, .xml	Yes	No
ODB++ <sup>1</sup>	.zip, .tar, .tgz, .tar.gz	Yes	No
GDS <sup>1</sup>	.gds	Yes	No
Touchstone <sup>2</sup>	.s2p, .s3p, .s4p, ...	No	Yes
SPICE Circuit Netlist <sup>3</sup>	.cir	Yes	Yes

<sup>1</sup> Requires the ECAD Import Module

<sup>2</sup> Requires either the AC/DC Module, RF Module, MEMS Module, or Wave Optics Module

<sup>3</sup> Requires either the AC/DC Module, RF Module, MEMS Module, Plasma Module, or Semiconductor Module

## MATERIAL DATABASES

From the **Materials** node, in the model tree, you can import material data on the MPH-file format as well as on a COMSOL-native XML format. You can also export material data on the COMSOL-native XML format. When importing material data from an MPH-file, only the material contents of the file are considered. For exporting material data on the MPH-file format, you simply save the MPH-file using the options on the **File** menu.

The Chemical Reaction Engineering Module and the Plasma Module can read CHEMKIN<sup>®</sup> files for simulating complex chemical reactions in the gas phase. The Plasma Module can read LXCAT files for sets of electron-impact collision cross sections. The Metal Processing Module import material properties from the software JMatPro<sup>®</sup>.

FILE TYPE	EXTENSION	READ	WRITE
COMSOL Model and Application	.mph	Yes	Yes
COMSOL Model XML	.xml	Yes	Yes
CHEMKIN <sup>®</sup> <sup>1</sup>	.dat, .txt, .inp <sup>3</sup>	Yes	No
CAPE-OPEN <sup>1</sup> (direct connection)	n/a	n/a	n/a
LXCAT file <sup>2</sup>	.lxcat, .txt	Yes	No
JMatPro <sup>®</sup> <sup>4</sup>	.xml	Yes	No

<sup>1</sup>Requires the Chemical Reaction Engineering Module or the Plasma Module. The Plasma Module only supports thermodynamic and transport data.

<sup>2</sup>Requires the Plasma Module.

<sup>3</sup>Any extension is allowed; these are the most common extensions.

<sup>4</sup>Requires the Metal Processing Module.

## MESH

The NASTRAN<sup>®</sup> Bulk Data file types are used to import a volumetric mesh. The VRML, STL, PLY, and 3MF file types are used to import a triangular surface mesh that can serve as a starting point for creating a volumetric mesh.

FILE TYPE	EXTENSION	READ	WRITE
3MF	.3mf	Yes	Yes
NASTRAN <sup>®</sup> Bulk Data	.nas, .bdf, .nastran, .dat	Yes	Yes
PLY	.ply	Yes	Yes
COMSOL Sectionwise	.txt, .csv, .dat	Yes	Yes
STL	.stl	Yes	Yes

FILE TYPE	EXTENSION	READ	WRITE
VRML, vI	.vrml, .wrl	Yes	No
VTK	.vtu	No	Yes

## IMAGES, MOVIES, AND AUDIO

Results visualization can be exported to a number of common image file types; See the table below. Images can also be read and used as interpolation functions for physics modeling. Animations can be exported to one of the Animated GIF, AVI, and WebM file types. Audio files can be imported and exported on the WAVE Audio File format.

FILE TYPE	EXTENSION	READ	WRITE
Animated GIF	.gif	No	Yes
AVI <sup>1</sup>	.avi	No	Yes
BMP	.bmp	Yes	Yes
EPS (ID graphs only)	.eps	No	Yes
GIF	.gif	Yes	Yes
glTF™	.glb	No	Yes
JPEG	.jpg, .jpeg	Yes	Yes
MP4 <sup>2</sup>	.mp4	Yes	No
OGV <sup>2</sup>	.ogv	Yes	No
PNG	.png	Yes	Yes
TIFF	.tif, .tiff	No	Yes
WAVE	.wav	Yes	Yes
WEBM	.webm	Yes	No

<sup>1</sup> Available for Windows® only

<sup>2</sup> Available in the Application Builder, for Windows® only, in the video form object

## PROGRAMMING LANGUAGES AND SPREADSHEET

Model files for Java® are editable files with the extension .java that contain sequences of COMSOL commands as Java® code. Edit the files in a text editor to add additional commands. You can compile these Java® files into Java® Class files with the extension .class and run them as separate applications. Program code used in model files for Java® is essentially identical to that of the Method Editor in the Application Builder. However, the Method Editor comes with an integrated Java® compiler.

Model files for MATLAB<sup>®</sup> are editable script files (M-files), similar to the model files for Java<sup>®</sup>, for use with MATLAB<sup>®</sup>. These model files, which have the extension .m, contain a sequence of COMSOL commands as a MATLAB<sup>®</sup> M-file. You can run the model files in MATLAB<sup>®</sup> like any other M-file scripts. It is also possible to edit the files in a text editor to include additional COMSOL commands or general MATLAB<sup>®</sup> commands. Running model files in the M-file format requires LiveLink<sup>™</sup> for MATLAB<sup>®</sup>.

With a license for LiveLink<sup>™</sup> for Excel<sup>®</sup>, you can save models on the Visual Basic for Applications (VBA) format for use with Excel<sup>®</sup>.

Compiled C-code can be linked with a model or application in several ways including the External Material and External Function interfaces in the Model Builder and as the External Library interface in the Application Builder.

FILE TYPE	EXTENSION	READ	WRITE
MATLAB <sup>®</sup> : Model file for MATLAB <sup>®</sup>	.m	No	Yes
MATLAB <sup>®</sup> : Function <sup>1</sup>	.m	Yes	No
Java <sup>®</sup> : Archive file	.jar <sup>6</sup>	Yes	No
Java <sup>®</sup> : Compiled model file for Java <sup>®</sup>	.class	Yes	No
Java <sup>®</sup> : Model file for Java <sup>®</sup>	.java	No	Yes
C: Function	.dll <sup>3</sup> ,.so <sup>4</sup> ,.dylib <sup>5</sup>	Yes	No
Fortran <sup>7</sup> : Function	.dll <sup>3</sup> ,.so <sup>4</sup>	Yes	No
Excel <sup>®2</sup>	.xlsx,.vba	Yes	Yes

<sup>1</sup>Requires LiveLink<sup>™</sup> for MATLAB<sup>®</sup>

<sup>2</sup>Requires LiveLink<sup>™</sup> for Excel<sup>®</sup>, available for Windows<sup>®</sup> only

<sup>3</sup>Available for Windows<sup>®</sup> only

<sup>4</sup>Available for Linux<sup>®</sup> only

<sup>5</sup>Available for macOS only

<sup>6</sup>Can be linked to a method in an application using the Application Builder

<sup>7</sup>Requires a C-wrapper to the Fortran code and to include the C-code DLL as an External C Library in the Application Builder. Alternatively, you can include a Fortran DLL directly as an External C Library in the Application Builder. Note: You need to consider the naming convention for exported Fortran function names. For example, in Windows<sup>®</sup>, it is typically required that Fortran function names are in uppercase.

## NUMERICAL AND INTERPOLATION DATA FORMATS

The grid, sectionwise, and spreadsheet file types can be read for defining interpolation functions. Furthermore, the sectionwise and spreadsheet file types can be read and used for defining interpolation curves and written for exporting results. In addition, tables can be copied and pasted on the spreadsheet format.

Parameters and variables can be imported and exported to the plain text, comma-separated values, or data file types.

The continuous and discrete color table text file types are used for user-defined color tables for results visualization.

Digital elevation model (DEM) files can be read and used as a parametric surface for defining a geometry.

FILE TYPE	EXTENSION	READ	WRITE
Copy and paste spreadsheet format	n/a	Yes	Yes
Excel® spreadsheet <sup>1</sup>	.xlsx	Yes	Yes
Table	.txt, .csv, .dat	Yes	Yes
Grid	.txt	Yes	Yes
Sectionwise	.txt, .csv, .dat	Yes	Yes
Spreadsheet	.txt, .csv, .dat	Yes	Yes
Parameters	.txt, .csv, .dat	Yes	Yes
Variables	.txt, .csv, .dat	Yes	Yes
Continuous and Discrete color table	.txt	Yes	No
Point data for Cut Point datasets	.txt	Yes	No
DEM	.dem	Yes	No
VTK	.vtu	No	Yes

<sup>1</sup>Requires LiveLink™ for Excel®, available for Windows® only

## Appendix E — Connecting with LiveLink™ Add-Ons

The following table shows the options to start COMSOL and the different linked partner software using the LiveLink™ add-on products.

COMSOL® Software	Can Start COMSOL from Partner Software	Can Start Partner Software from COMSOL	Can Connect Running Sessions
LiveLink™ for Excel®	Yes <sup>1</sup>	Yes <sup>2</sup>	No
LiveLink™ for MATLAB®	Yes <sup>3</sup>	Yes <sup>5</sup>	Yes <sup>5</sup>
LiveLink™ for Simulink®	No	Yes <sup>6</sup>	No
LiveLink™ for AutoCad®	No	No	Yes
LiveLink™ for Revit®	No	No	Yes
LiveLink™ for PTC®/Creo® Parametric™	No	No	Yes
LiveLink™ for Inventor®			
- Bidirectional Mode	No	No	Yes
- One Window Mode	Yes	No	No
LiveLink™ for Solid Edge®	No	No	Yes
LiveLink™ for SOLIDWORKS®	No	No	Yes

<sup>1</sup>When you open a model from Excel®, a model window starts and a link is established automatically. The model window is an output window that displays geometry, mesh, and results.

<sup>2</sup>A model that includes a table reference to an Excel® spreadsheet automatically starts an Excel® process in the background when the model is run in the COMSOL Desktop environment.

<sup>3</sup>You can start a COMSOL Multiphysics server from a MATLAB® session using the **system** command and then connect to it using **mphstart** in the MATLAB® command prompt.

<sup>4</sup>The COMSOL Multiphysics with MATLAB® desktop shortcut starts a COMSOL Multiphysics server and MATLAB®, then connects them automatically. When you run a COMSOL Multiphysics

model in the COMSOL Desktop interface that includes a MATLAB<sup>®</sup> function (Global Definitions > Functions), a MATLAB<sup>®</sup> engine and connection is started automatically.

<sup>5</sup>You can connect a MATLAB<sup>®</sup> session to a running COMSOL Multiphysics server using the command **mphstart** in the MATLAB<sup>®</sup> command prompt.

<sup>6</sup>The COMSOL Multiphysics with Simulink<sup>®</sup> desktop shortcut starts a COMSOL Multiphysics server and MATLAB<sup>®</sup>, then connects them automatically. You can then start Simulink<sup>®</sup> and add a COMSOL Cosimulation block where you load a cosimulation file to run a cosimulation.



# Index

---

- A**
  - AC/DC Module 76, 101
  - accuracy
    - convergence analysis 66
  - Add Material window
    - busbar model 89
    - opening 44, 89
  - Add Multiphysics
    - button 102
    - window 102
  - add-in 126
  - add-on modules
    - AC/DC Module 76, 99, 101
    - Application Libraries 33
    - CAD Import Module 214, 256
    - Chemical Reaction Engineering Module 259
    - Design Module 214, 220, 256
    - ECAD Import Module 258
    - MEMS Module 146
    - physics list 40, 78
    - Plasma Module 259
    - Structural Mechanics Module 38, 50, 66
    - study types 80
  - advanced topics 135
  - all combinations
    - parametric sweep 170
  - analysis
    - convergence 66
    - example, parametric sweep 71
  - animation 24, 180
  - application 13, 117
  - Application Builder 6, 8, 11, 13, 31, 117, 239
  - Application Gallery 35
  - Application Libraries 17
    - examples 33
    - file types 34
    - MPH-files 10, 33
    - window 35
  - Application Library update 35
  - autocompletion
    - parameter and variable names 177
    - parameters and variables 83
  - average temperature 172
- B**
  - Basic template 128
  - Blank form template 129
  - blank model, creating 18, 20
  - boundaries 98
    - adding to selection 100
    - variables scope 31
  - boundary condition 96
    - automatically defined 50
  - boundary load 49
  - busbar, setting 96
  - electric current 96, 99
  - fixed constraint 48
  - free 47
  - ground, electrical 101
  - heat transfer 96
  - insulating 98
  - material interface 50, 66
  - settings window 8
- boundary load 49
- boundary number, graphics display 52
- boundary section
  - context menu 97
- boundary selection, busbar model 98
- boundary surface normal direction, up and down 53, 243
- Browse 42

- Browse From 42
- Build All button
  - geometry 86
  - meshes 56, 105
- built-in
  - constants, functions, and variables 33
  - materials 44, 89
  - variables 109
- button object 121
- Button, Form Objects 123
- C** CAD files, storing in database 210
- CAD Import Module 214, 256
- Cancel button 10, 29
- case, parameter 27, 170
- chamfer 214
- Chemical Reaction Engineering Module 259
- clip plane 54
- cloud computing 181
- Cluster Computing node 181, 184
- cluster job 184
- Cluster Sweep node 181, 184
- color theme 15
- coloring
  - materials 93
  - selections 93
- command sequence 124, 132
- Compact MPH-files 34
- compiler 12
- component coupling 172
- Component node, adding materials 89
- computing studies 71
- COMSOL Client 13
- COMSOL Compiler 12
- COMSOL Desktop environment
  - customizing 27
  - on Linux 23
  - on macOS 23
  - overview 6
- COMSOL Multiphysics 12
  - native CAD format 42
  - opening 39
- COMSOL Server 13
- constants
  - mathematical and physical types 33
- constraints 214
- context menu
  - domain and boundary sections 97
- contextual tab 21
- contributing node 154
- convergence analysis 66
- Convergence plot 9, 106
- cooling
  - air stream 75
  - natural convection 81
- coupling operator 172
- Create Selection 32
  - button 149
- custom settings window 126
- customized desktop 27
- D** dark theme 15
- datasets, defined 24
- default feature 96
- degrees of freedom 66, 73
- derivatives 33
- Derived Values 73, 114
  - defined 24
  - Global Evaluation 72
  - Volume Maximum 66, 72, 114
- Design Module 214, 220, 256
- dimensions 214
- discretize 56
- documentation, models 10, 33
- domain level 97
- domain section
  - context menu 97
- domains
  - materials 92

- remove from selection 92
  - variables scope 31
- down, surface normal direction 53, 243
- draft, Model Manager 199
- draft, saving as version 204
- dynamic help 11, 29
- E** ECAD Import Module 258
- edges
  - variables scope 31
- Editor Templates window 123
- eigenfrequency analysis 24
- Electric Currents interface
  - defining boundary conditions 97
  - multiphysics 80, 101
  - overview 96
- electric potential 76
  - physics node 99
  - voltage drop, parameter 81
- electrical heating 75
- empty
  - selection 49
- Enable Tooltip 138
- environment reflections 93
- equation
  - built-in 96
  - user-defined 63
- evaluating
  - volume maximum 66, 112, 114
  - von Mises stress 67
- Evaluation Group 73, 114
  - automatic re-evaluation 73
- example
  - advanced, electrical heating 75
  - basic, structural mechanics 38
- Excel® 261, 263
- exclude data, Model Manager 208
- exclusive node 153
- executable 12
- Export node 24
- exporting images 115
- expressions
  - Boolean 64
  - manual entry 68, 81
  - replacing 64, 109, 112
  - units, specifying 67
  - user-defined 63
- External Process window 9
- F** file import 42
- File menu 16
- fillet 214, 220
- filter
  - Model Builder 37
- Filter Options menu 37
- find
  - parameters and variables 84
- finite element
  - mesh 56
  - preconditioning 71
  - tetrahedra 56
- Fixed Constraint node 48
- Floating Network License 181
- Form Editor 11, 121
- form objects 117
- form union, geometry 86
- frequency response 25
- frequency-domain study 24
- functions
  - advanced topics 136
  - built-in 33
  - mathematical 33
  - scope 81
- Functions node 81
- G** geometric dimensions
  - parameters, and 10, 26, 229
  - parametric sweep 81
- geometry
  - building 81

- CAD format *41*
  - importing *41*
  - in Application Libraries *85*
  - loading from file *81, 85*
  - operations *214*
  - parameterized *10, 26, 81, 85, 229*
  - sequence *214*
  - settings window *8*
  - Geometry node *36*
  - Global Definitions node *23, 27*
    - functions *81*
    - parameters *81*
    - scope *31, 81*
    - variables *30*
  - global parameters *27, 46, 69, 81*
    - expression *26*
  - gTTF-file format *116*
  - graphics
    - rendering and hardware *14*
  - Graphics menus *22*
  - graphics object *120, 122, 131*
  - Graphics toolbar
    - default view button *48, 60, 101, 111*
    - image snapshot button *115*
    - zoom extents button *87, 108*
  - Graphics window *7, 9, 22, 29*
    - geometry, and *42*
    - plot *58*
    - rotate geometry *48, 107, 108*
    - selecting boundary *48, 49, 101*
    - toolbar *7*
    - using *43, 87*
    - zoom box *49*
  - Ground, boundary condition *100*
  - grouping
    - nodes *30*
- H** Heat Transfer in Solids interface
  - defining boundary conditions *97*
  - multiphysics *80, 101*
  - overview *96*
- Help window *11*
  - opening *23*
- high performance computing *181*
- Home tab *21*
- HPC *181*
- hybrid parallelism *182*
- I** Image Snapshot button *115*
- images, creating thumbnails *115*
- importing
  - file *42*
  - geometry *41*
- information windows *7, 9, 29*
- initial conditions *8*
- Initial Values node
  - Electric Currents interface *97*
  - Heat Transfer in Solids interface *97*
  - Solid Mechanics interface *47*
- input fields *119*
- Input Parameters
  - for part *230*
- Isosurface plot *179*
- iterative solver
  - preconditioning *71*
- J** Java file *37, 260*
- Joule heating
  - equations *96*
  - multiphysics coupling *101*
  - multiphysics interface *78*
- L** Laminar Flow interface *158*
- Linux
  - clusters *184*
  - version *23*
- LiveLink™ add-ons *263*
- local database *189*
- loft *214*
- Log window *9, 58*
- M** macOS version *23*

- Main Window Editor *11*
- Material Browser
  - defined *10*
  - material contents section *44, 90*
- material color and texture *93*
- material interface
  - mechanical contact *50, 66*
- material rendering *93*
- materials
  - copper *75*
  - domains, assigning *91*
  - model tree *36*
  - settings window *8*
  - steel *44, 63*
  - titanium alloy *75*
- Materials node *44, 89*
- mathematical constants and functions
  - 33*
- MATLAB® *261*
- Max/Min Volume plot *68*
- Maximum and minimum values table
  - 113*
- MEMS Module
  - thermal expansion, and *146*
- mesh
  - convergence analysis, and *66*
  - density *69*
  - finite element *56*
  - model tree, and *36*
  - parameterizing *69, 103*
  - physics-controlled, default *103*
  - refining *69*
  - settings *56*
  - unstructured tetrahedral *103*
  - user-controlled *69, 103*
- mesh element size
  - parameters, defining *26, 104*
  - settings *56*
- mesh-convergence analysis *73*
- Message Passing Interface (MPI) *182*
- Messages window *9, 58*
- method *127*
  - model *31*
- Method Call *127*
- Method editor *11, 127*
- M-file *37, 261*
- midsurface *214*
- modal tab *21*
- Model Builder *6, 117, 129*
  - defined *11*
  - example *36*
  - expanding sections *97*
  - geometry import *41*
  - keyboard shortcuts *236*
  - node sequence example *47*
  - the ribbon, and *21*
  - toolbar *6*
  - window *28*
- model history *37*
- Model Manager *6, 12, 17, 188*
  - draft *199*
  - exclude data *208*
  - Open From *189*
  - Save To *189*
  - search *213*
  - Versions window *196*
  - workspace *212*
- model method *31*
- model tree *6, 28*
  - building *23*
  - defined *81*
  - example *36*
  - geometry *36*
  - Global Definitions node *24, 46, 81*
  - Materials node *36, 44*
  - Model Builder *11*
  - nodes *23*
  - Results node *24*

- ribbon 21
    - root node 23
    - Study node 24, 36
  - Model Wizard
    - adding physics 24, 40, 78, 192
    - Component node, and 24
    - creating a new model 18
    - General Studies 40
    - More Studies 40
    - opening 39, 78
    - preset studies 80, 192
    - space dimension 39, 78
    - study 24, 79
  - models
    - defining 11
    - discretization 56
    - documentation 10, 33
    - saving 88, 208
    - structural mechanics 38
    - symmetry 108
    - workflow 36
  - MPHBIN-file 256
  - MPH-file 256
    - excluding data when saving 208
    - full and compact 34
    - saving 88, 116
  - MPHPHB-file 256
  - MPHXT-file 256
  - MPI 182
  - multicore processors 181
  - multiphysics interface 80
  - multiphysics models 75
  - Multiphysics node 96, 97, 102, 147
  - multiphysics phenomena 75
  - Multislice plot 107
- N**
- New 16
  - New Form wizard 117
    - Ribbon buttons tab 132
  - no solutions stored, message 35
  - node groups 30
  - nodes 23
    - default feature 47
    - reordering 37
  - O**
    - Open 16
    - Open From 17
      - Model Manager 189
    - OpenGL 14, 94
    - Override and Contribution 47, 154
  - P**
    - parallel computing 181
    - parameter case 27, 170
    - parameter switch
      - parametric sweep 170
    - parameters 26, 120, 131
      - adding 50
      - defining 69, 81
      - displaying value 51
      - editing 50, 86
      - expression 26, 69
      - global 27
      - meshes, and 69
      - name 69
      - range of values 70
      - results 30, 178
      - scope 81
      - using, referencing 99
    - Parameters node 81, 136
    - parametric geometry model 214
    - parametric study 81
    - parametric sweep 26
      - all combinations 170
      - example 70
      - meshes, and 69
      - parameter switch 170
      - range, defining 70
      - specified combinations 170
    - part 10, 229
      - Input Parameters 230

- Part Libraries 229
- physics
  - adding 78
  - boundary conditions 96
  - electromagnetic heating 78
  - heat transfer 78
  - Joule heating 75, 96
  - laminar flow 158
  - model tree 36
- physics interface 18, 80
  - Electric Currents 80
  - Heat Transfer in Solids 80
  - Joule Heating 78
  - Laminar Flow 158
  - Solid Mechanics 40, 192
- Plasma Module 259
- player 180
- plot
  - regenerate after solving 74
- plot group 24
  - 3D, adding 63
- Plot window 29
- plots
  - expression, user-defined 63
  - max/min volume 68
  - model tree 36
  - regenerating 68
  - windows 9
- points, variables scope 31
- Poisson's ratio 91
- polynomial functions 56
- preconditioning 71
- preferences 14
- preset studies 80
- Preview MPH-files 35
- principal stress 153
- program code
  - model file for Java 37
  - model M-file 37
- progress bar 11, 29
- Progress window 9, 58
- Q** Quick Access Toolbar 6, 8, 22, 28
- R** Recent 17
- Record Code 128
- renaming plot groups 64
- rendering options 14
- reports, defined 24
- reserved name 33
- Reset Window Layout 132
- resizable graphics window 128
- resolution of curvature, mesh 104
- results
  - color table range 107, 109
  - derived values 66, 72, 114
  - displaying 59
  - parameters 30, 178
  - units, changing 59
- Results node
  - 3D plot group 68, 109, 151
  - busbar defaults 107
  - subnodes 24
  - surface node, adding 109, 151
- Revert to Saved 17
- ribbon 7, 28
  - Add Material 44, 95, 157
  - Build All 86
  - Build Mesh 105
  - Compute 71, 151, 167
  - defined 8, 21
  - example 7
  - importing geometry 41
  - Model Builder 21
  - Physics tab 48, 147
  - Windows 10, 58, 218
  - Work Plane 216
- Ribbon buttons 132
- Ribbon buttons tab, New Form wizard

- 132
- root node
  - default units 171
  - defined 23
  - model thumbnails 115
  - Model Wizard 39
- Run Application 16
- running simulations 106
- S** Save 17
- Save As 17
- Save To 17
  - Model Manager 189
- saving files 88, 116
- scheduler
  - Grid Engine 184
  - IBM LSF 184
  - Microsoft HPC Pack 184
  - Open Grid Scheduler 184
  - PBS 184
  - SLURM 184
- scope
  - global definitions 81
  - parameters and variables 31
  - parameters and variables, defined 26
  - variable name 32
- search
  - parameters and variables 84
- search, in Model Manager database 213
- Select Study window 20
- selecting
  - boundaries 51
  - multiple boundaries 149
  - using the graphics window context
    - menus 53
- selecting internal surfaces 52
- Selection 32, 52, 93
  - empty 49
- selection 149
- Selection List window 10, 218
- selection of geometry objects, domains,
  - boundaries, edges, and points 52
- Settings Form 127
- Settings Forms 127
- Settings window 6, 8, 23, 28
  - customized 126
- settings window
  - keyboard shortcut 236
- shared memory parallelism 181
- Show Material Color and Texture 93
- Show Selection Colors 93
- simulation, running 106
- Single form template 118, 129
- skybox image 94
- software rendering 14
- Solid Mechanics interface 40, 192
  - add-on modules 146
- Solved MPH files 34
- solvers
  - configurations 71
  - iterative 70
  - stationary 58, 71
  - using 58
- space dimension 18
- specified combinations
  - parametric sweep 170
- Stationary study 40, 58, 192
- steady-state study 24
- Streamline Multislice plot 107
- structural analysis 38
- structural displacement field 56
- structural mechanics
  - design 65
  - plastic deformation 63
  - stresses and strains 75, 91
  - von Mises stress 59
- Structural Mechanics Module
  - application library 38
  - mechanical contact 50, 66



- thermal expansion *146*
- studies
  - computing solutions *71, 106*
  - defining *58*
  - example, multigrid iterative *71*
  - example, stationary *58*
  - model tree *36*
  - preset *80*
  - types *24*
- Study node *24*
  - solution sequence *106*
- Suppress Selection Highlight *93*
- surface normal direction, graphics display *52*
- surface normal direction, up and down *53, 243*
- Surface plot
  - color table range *110*
  - deformation *59*
  - electrical current density *109*
  - replace expression *109*
  - settings *64*
  - updating *108, 109*
- T** table
  - Maximum and minimum *113*
- Table window *9*
  - graph plot *72*
  - wrench results *67*
- Tables node *24*
- tables, evaluating *72*
- temperature *107, 167*
- temperature, average *172*
- Test Application *123, 133*
- tetrahedron, polynomial functions *56*
- thermal expansion *75, 91*
- thicken *214*
- thumbnail image *115*
- time-dependent study *24*
- torque, applied *38*
- U** unit, changing *59, 152*
  - up, surface normal direction *53, 243*
- update COMSOL Application Libraries *35*
- Update Solution *177*
- user interface
  - COMSOL Desktop *6*
  - overview *6*
- user-controlled mesh *69*
- V** variables
  - advanced topics *136*
  - built-in *33*
  - example, built-in *72*
  - expression *30*
  - scope *81*
  - scope, limit *31*
- Variables node *30, 81*
- version
  - control *192*
  - opening *197*
  - saving *193*
- Versions window, Model Manager *196*
- visualization *9*
  - color table *107, 109*
- Volume Maximum, evaluating *66, 112, 114*
- Volume plot *107*
- von Mises stress *59, 153*
- W** Window Layout *132*
- Windows list *58, 218*
- wizard
  - New Form *117*
- workflow *33*
- Workspace *117, 129*
- Y** yield stress *38, 63*
- Young's modulus *91*
- Z** zoom *167*
- Zoom Extents command *125*

